

Command Guide

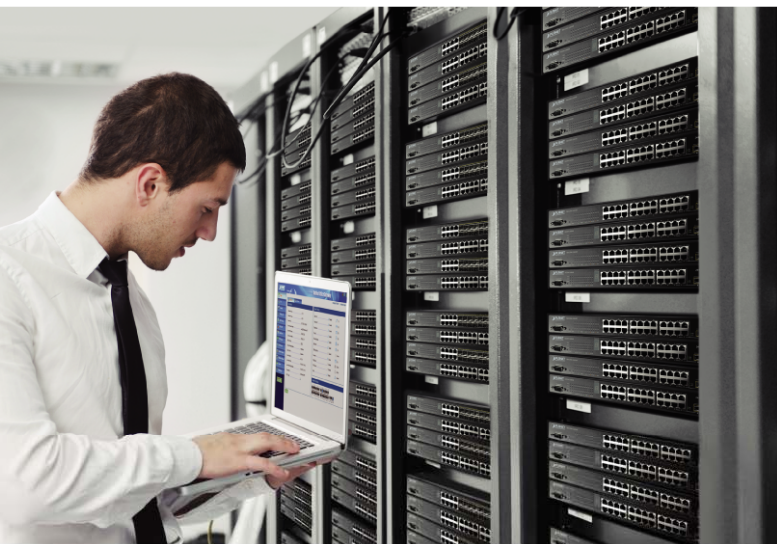

**L2+ 24-Port Gigabit Managed Switch
with Hardware Layer3 IPv4/IPv6
Static Routing**

▶ GS-5220-16S8C / GS-5220-16S8CR



Contents

Chapter 1 COMMAND LINE INTERFACE.....	20
1.1 Accessing the CLI.....	20
1.2 Command Line Modes.....	20
1.3 Requirements	21
Chapter 2 CONSOLE CLI MANAGEMENT.....	22
2.1 Terminal Setup	22
2.2 Logon to the Console	24
2.3 Configuring IP Address	24
Chapter 3 TELNET CLI MANAGEMENT	27
3.1 Telnet Login.....	27
Chapter 4 Commands for CLI Configuration.....	28
4.1 clear	28
4.1.1 clear access management statistics	28
4.1.2 clear access-list ace statistics.....	28
4.1.3 clear dot1x statistics interface	29
4.1.4 clear eps.....	29
4.1.5 clear erps.....	30
4.1.6 clear erps statistics	30
4.1.7 clear evc statistics	30
4.1.8 clear ip arp.....	31
4.1.9 clear ip dhcp detailed statistics all	31
4.1.10 clear ip dhcp detailed statistics client.....	32
4.1.11 clear ip dhcp detailed statistics helper	32
4.1.12 clear ip dhcp detailed statistics server	33
4.1.13 clear ip dhcp detailed statistics snooping	33
4.1.14 clear ip dhcp relay statistics.....	34
4.1.15 clear ip dhcp server binding.....	34
4.1.16 clear ip dhcp server binding automatic	35
4.1.17 clear ip dhcp server binding expired	35
4.1.18 clear ip dhcp server binding manual	35
4.1.19 clear ip igmp snooping statistics.....	36

4.1.20 clear ip igmp snooping vlan	36
4.1.21 clear ip statistics icmp icmp-msg	37
4.1.22 clear ip statistics icmp interface vlan	37
4.1.23 clear ip statistics system icmp icmp-msg	38
4.1.24 clear ip statistics system icmp interface vlan	38
4.1.25 clear ipv6 mld snooping statistics	39
4.1.26 clear ipv6 mld snooping vlan	39
4.1.27 clear ipv6 neighbors	40
4.1.28 clear ipv6 statistics icmp icmp-msg	40
4.1.29 clear ipv6 statistics icmp interface vlan.....	41
4.1.30 clear ipv6 statistics system icmp icmp-msg	41
4.1.31 clear ipv6 statistics system icmp interface vlan	42
4.1.32 clear lacp statistics	42
4.1.33 clear lldp statistics	43
4.1.34 clear logging error info	43
4.1.35 clear logging error warning	44
4.1.36 clear logging info error	44
4.1.37 clear logging info warning	45
4.1.38 clear logging warning error	45
4.1.39 clear logging warning info	46
4.1.40 clear mac address-table	46
4.1.41 clear mep	46
4.1.42 clear mvr name	47
4.1.43 clear mvr statistics	47
4.1.44 clear mvr vlan	47
4.1.45 clear network-clock clk-source	48
4.1.46 clear spanning-tree detected-protocols interface *	48
4.1.47 clear spanning-tree detected-protocols interface *	49
4.1.48 clear spanning-tree detected-protocols interface GigabitEthernet	49
4.1.49 clear spanning-tree detected-protocols interface 10GigabitEthernet	50
4.1.50 clear spanning-tree statistics interface *	50
4.1.51 clear spanning-tree statistics interface GigabitEthernet.....	50
4.1.52 clear spanning-tree statistics interface 10GigabitEthernet	51
4.1.53 clear statistics *	51
4.1.54 clear statistics GigabitEthernet	52
4.1.55 clear statistics 10GigabitEthernet	52
4.2 configure terminal.....	53
4.2.1 aaa authentication login console local	53
4.2.2 aaa authentication login console radius.....	53
4.2.3 aaa authentication login console tacacs	53
4.2.4 aaa authentication login http local	54

4.2.5 aaa authentication login http radius	54
4.2.6 aaa authentication login http tacacs	55
4.2.7 aaa authentication login ssh local.....	55
4.2.8 aaa authentication login ssh radius	56
4.2.9 aaa authentication login ssh tacacs.....	56
4.2.10 aaa authentication login telnet local.....	57
4.2.11 aaa authentication login telnet radius	57
4.2.12 aaa authentication login telnet tacacs.....	58
4.2.13 access management	58
4.2.14 access-list ace	59
4.2.15 access-list ace update	60
4.2.16 access-list rate-limiter.....	61
4.2.17 access-list rate-limiter pps	62
4.2.18 aggregation mode.....	62
4.2.19 aggregation mode.....	63
4.2.20 banner	63
4.2.21 banner exec.....	64
4.2.22 banner login.....	65
4.2.23 banner motd	66
4.2.24 clock summer-time	66
4.2.25 clock timezone.....	67
4.2.26 default access-list rate-limiter	67
4.2.27 dot1x authentication timer inactivity.....	68
4.2.28 dot1x authentication timer re-authenticate.....	68
4.2.29 dot1x feature	69
4.2.30 dot1x guest-vlan	69
4.2.31 dot1x guest-vlan supplicant	69
4.2.32 dot1x max-reauth-req	70
4.2.33 dot1x system-auth-control	70
4.2.34 dot1x timeout quiet-period	71
4.2.35 dot1x timeout tx-period	71
4.2.36 enable password	72
4.2.37 enable password level	72
4.2.38 enable secret.....	73
4.2.39 end	74
4.2.40 erps <1-64> guard	74
4.2.41 erps <1-64> holdoff	75
4.2.42 erps <1-64> major	75
4.2.43 erps <1-64> mep	76
4.2.44 erps <1-64> mep	77
4.2.45 erps <1-64> rpl neighbor	77

4.2.46 erps <1-64> rpl owner	78
4.2.47 erps <1-64> sub	78
4.2.48 erps <1-64> topology-change propagate.....	79
4.2.49 erps <1-64> topology-change propagate.....	79
4.2.50 erps <1-64> vlan.....	80
4.2.51 evc.....	80
4.2.52 evc ece	81
4.2.53 evc ece update	84
4.2.54 evc policer	87
4.2.55 evc policer update	88
4.2.56 evc update.....	89
4.2.57 exit.....	90
4.2.58 green-ethernet led interval.....	90
4.2.59 green-ethernet led on-event	91
4.2.60 gvrp	91
4.2.61 gvrp max-vlans	92
4.2.62 gvrp time.....	92
4.2.63 help.....	93
4.2.64 hostname.....	94
4.2.65 interface * 10GigabitEthernet GigabitEthernet.....	94
4.2.65.1 access-list action permit	95
4.2.65.2 access-list action deny	95
4.2.65.3 access-list logging	96
4.2.65.4 access-list policy	96
4.2.65.5 access-list port-state	97
4.2.65.6 access-list rate-limiter.....	97
4.2.65.7 access-list redirect interface.....	98
4.2.65.8 access-list shutdown	98
4.2.65.9 aggregation group	99
4.2.65.10 description	99
4.2.65.11 do	100
4.2.65.12 dot1x guest-vlan	100
4.2.65.13 dot1x port-control	101
4.2.65.14 dot1x radius-qos.....	101
4.2.65.15 dot1x radius-vlan	102
4.2.65.16 dot1x re-authenticate.....	102
4.2.65.17 duplex.....	103
4.2.65.18 end	103
4.2.65.19 evc dei	104
4.2.65.20 evc l2cp discard(GG).....	104
4.2.65.21 evc l2cp forward(GG)	105

4.2.65.22 evc l2cp peer(GG)	105
4.2.65.23 evc update dei	106
4.2.65.24 excessive-restart	107
4.2.65.25 exit.....	107
4.2.65.26 flowcontrol	108
4.2.65.27 green-ethernet energy-detect(GG)	108
4.2.65.28 green-ethernet short-reach(GG).....	109
4.2.65.29 gvrp join-request vlan(GG)	109
4.2.65.30 gvrp leave-request vlan(GG)	110
4.2.65.31 ip arp inspection check-vlan	110
4.2.65.32 ip arp inspection logging.....	111
4.2.65.33 ip arp inspection trust	111
4.2.65.34 ip dhcp snooping trust	112
4.2.65.35 ip igmp snooping filter	112
4.2.65.36 ip igmp snooping immediate-leave	113
4.2.65.37 ip igmp snooping max-groups	113
4.2.65.38 ip igmp snooping mrouter	114
4.2.65.39 ip verify source	114
4.2.65.40 ip verify source limit.....	115
4.2.65.41 ipv6 mld snooping filter.....	115
4.2.65.42 ipv6 mld snooping immediate-leave	116
4.2.65.43 ipv6 mld snooping max-groups.....	116
4.2.65.44 ipv6 mld snooping mrouter	117
4.2.65.45 lacp.....	117
4.2.65.46 lacp key	118
4.2.65.47 lacp port-priority.....	118
4.2.65.48 lacp role.....	119
4.2.65.49 lacp timeout	119
4.2.65.50 lldp cdp-aware	120
4.2.65.51 lldp med media-vlan policy-list.....	120
4.2.65.52 lldp med transmit-tlv	121
4.2.65.53 lldp receive	121
4.2.65.54 lldp tlv-select management-address	122
4.2.65.55 lldp tlv-select port-description	122
4.2.65.56 lldp tlv-select system-capabilities	123
4.2.65.57 lldp tlv-select system-description	123
4.2.65.58 lldp tlv-select system-name	124
4.2.65.59 lldp transmit	124
4.2.65.60 loop-protect	125
4.2.65.61 loop-protect action.....	125
4.2.65.62 loop-protect tx-mode	126

4.2.65.63 loop-protect tx-mode	126
4.2.65.64 mac address-table learning	127
4.2.65.65 media-type.....	127
4.2.65.66 mtu	128
4.2.65.67 mvr immediate-leave	128
4.2.65.68 mvr name	129
4.2.65.69 mvr vlan.....	129
4.2.65.70 network-clock synchronization ssm	130
4.2.65.71 no	131
4.2.65.72 ping ip.....	131
4.2.65.73 poe mode	132
4.2.65.74 poe pdcheck IP.....	132
4.2.65.75 poe pdcheck action	133
4.2.65.76 poe pdcheck enable	133
4.2.65.77 poe pdcheck interval	134
4.2.65.78 poe pdcheck reboot-time	135
4.2.65.79 poe pdcheck retry-count.....	135
4.2.65.80 poe power limit	136
4.2.65.81 poe priority.....	136
4.2.65.82 poe time-range	137
4.2.65.83 port-security.....	137
4.2.65.84 port-security maximum	138
4.2.65.85 port-security violation	138
4.2.65.86 port-security violation	139
4.2.65.87 pvlan.....	140
4.2.65.88 pvlan isolation.....	140
4.2.65.89 qos cos.....	141
4.2.65.90 qos dei.....	141
4.2.65.91 qos dpl.....	142
4.2.65.92 qos dscp-classify	142
4.2.65.93 qos dscp-remark.....	143
4.2.65.94 qos dscp-translate	143
4.2.65.95 qos map cos-tag.....	144
4.2.65.96 qos map tag-cos.....	145
4.2.65.97 qos pcp.....	145
4.2.65.98 qos policer	146
4.2.65.99 qos queue-policer queue	147
4.2.65.100 qos queue-shaper queue.....	147
4.2.65.101 qos shaper.....	148
4.2.65.102 qos storm broadcast.....	148
4.2.65.103 qos storm unicast	149

4.2.65.104 qos storm unknown	149
4.2.65.105 qos tag-remark	150
4.2.65.106 qos tag-remark mapped	151
4.2.65.107 qos trust dscp	151
4.2.65.108 qos trust tag.....	152
4.2.65.109 rmon collection history.....	152
4.2.65.110 rmon collection stats.....	153
4.2.65.111 shutdown	154
4.2.65.112 spanning-tree	154
4.2.65.113 spanning-tree auto-edge	155
4.2.65.114 spanning-tree bpdu-guard	155
4.2.65.115 spanning-tree edge.....	156
4.2.65.116 spanning-tree link-type	156
4.2.65.117 spanning-tree mst <Instance : 0-7> cost	157
4.2.65.118 spanning-tree mst <Instance : 0-7> cost	157
4.2.65.119 spanning-tree restricted-role.....	158
4.2.65.120 spanning-tree restricted-tcn.....	159
4.2.65.121 speed	159
4.2.65.122 switchport access vlan	160
4.2.65.123 switchport forbidden vlan add.....	160
4.2.65.124 switchport forbidden vlan remove.....	161
4.2.65.125 switchport hybrid acceptable-frame-type	161
4.2.65.126 switchport hybrid allowed vlan.....	162
4.2.65.127 switchport hybrid egress-tag.....	163
4.2.65.128 switchport hybrid ingress-filtering	163
4.2.65.129 switchport hybrid native vlan	164
4.2.65.130 switchport hybrid port-type	164
4.2.65.131 switchport mode	165
4.2.65.132 switchport vlan ip-subnet.....	166
4.2.65.133 switchport vlan mac.....	166
4.2.65.134 switchport vlan mapping.....	167
4.2.65.135 switchport vlan protocol group.....	168
4.2.65.136 switchport voice vlan discovery-protocol	168
4.2.65.137 switchport voice vlan mode	169
4.2.65.138 switchport voice vlan security.....	169
4.2.66 interface vlan	170
4.2.66.1 do	170
4.2.66.2 end	171
4.2.66.3 exit.....	171
4.2.66.4 ip address.....	172
4.2.66.5 ip address dhcp	172

4.2.66.6 ip address dhcp fallback.....	173
4.2.66.7 ip dhcp server.....	174
4.2.66.8 ip igmp snooping	174
4.2.66.9 ip igmp snooping compatibility.....	175
4.2.66.10 ip igmp snooping last-member-query-interval.....	175
4.2.66.11 ip igmp snooping priority	176
4.2.66.12 ip igmp snooping querier address	177
4.2.66.13 ip igmp snooping querier election.....	177
4.2.66.14 ip igmp snooping query-interval.....	178
4.2.66.15 ip igmp snooping query-max-response-time.....	178
4.2.66.16 ip igmp snooping robustness-variable	179
4.2.66.17 ip igmp snooping unsolicited-report-interval	180
4.2.66.18 ipv6 address	180
4.2.66.19 ipv6 mld snooping	181
4.2.66.20 ipv6 mld snooping compatibility.....	181
4.2.66.21 ipv6 mld snooping last-member-query-interval.....	182
4.2.66.22 ipv6 mld snooping priority.....	182
4.2.66.23 ipv6 mld snooping querier election	183
4.2.66.24 ipv6 mld snooping query-interval	184
4.2.66.25 ipv6 mld snooping query-max-response-time	184
4.2.66.26 ipv6 mld snooping robustness-variable	185
4.2.66.27 ipv6 mld snooping unsolicited-report-interval	185
4.2.66.28 no	186
4.2.67 ip arp inspection	186
4.2.68 ip arp inspection entry interface.....	187
4.2.69 ip arp inspection translate.....	187
4.2.70 ip arp inspection translate interface	188
4.2.71 ip arp inspection vlan.....	189
4.2.72 ip dhcp excluded-address.....	189
4.2.73 ip dhcp pool.....	190
4.2.73.1 broadcast.....	191
4.2.73.2 client-identifier fqdn	191
4.2.73.3 client-identifier mac-address.....	191
4.2.73.4 client-name.....	192
4.2.73.5 default-router	192
4.2.73.6 dns-server	193
4.2.73.7 do	193
4.2.73.8 domain-name	194
4.2.73.9 end	194
4.2.73.10 exit.....	195
4.2.73.11 hardware-address	195

4.2.73.12 host	196
4.2.73.13 lease.....	197
4.2.73.14 netbios-name-server	197
4.2.73.15 netbios-node-type.....	198
4.2.73.16 netbios-scope	198
4.2.73.17 network.....	199
4.2.73.18 nis-domain-name.....	199
4.2.73.19 nis-server.....	200
4.2.73.20 no	200
4.2.73.21 ntp-server	201
4.2.73.22 vendor	201
4.2.74 ip dns proxy	202
4.2.75 ip helper-address.....	202
4.2.76 ip http secure-redirect.....	203
4.2.77 ip http secure-server.....	203
4.2.78 ip igmp host-proxy	204
4.2.79 ip igmp host-proxy leave-proxy.....	204
4.2.80 ip igmp snooping	205
4.2.81 ip igmp snooping vlan.....	205
4.2.82 ip igmp ssm-range	206
4.2.83 ip igmp unknown-flooding.....	206
4.2.84 ip name-server	207
4.2.85 ip name-server dhcp.....	207
4.2.86 ip name-server dhcp interface vlan.....	208
4.2.87 ip route	208
4.2.88 ip routing.....	209
4.2.89 ip source binding interface.....	210
4.2.90 ip ssh	210
4.2.91 ip verify source	211
4.2.92 ip verify source translate.....	211
4.2.93 ipmc profile	212
4.2.94 ipmc profile <word16>	212
4.2.94.1 default range	213
4.2.94.2 description.....	213
4.2.94.3 do	214
4.2.94.4 end	214
4.2.94.5 exit.....	215
4.2.94.6 no	215
4.2.94.7 range	216
4.2.95 ipv6 mld host-proxy	216
4.2.96 ipv6 mld host-proxy leave-proxy	217

4.2.97 ipv6 mld snooping.....	217
4.2.98 ipv6 mld snooping vlan	218
4.2.99 ipv6 mld ssm-range	218
4.2.100 ipv6 mld unknown-flooding	219
4.2.101 ipv6 route.....	219
4.2.102 lacp system-priority.....	220
4.2.103 line.....	221
4.2.103.1 do	221
4.2.103.2 editing.....	222
4.2.103.3 end	222
4.2.103.4 exec-banner	223
4.2.103.5 exec-timeout.....	223
4.2.103.6 exec-timeout.....	224
4.2.103.7 exit.....	224
4.2.103.8 history size	225
4.2.103.9 length	225
4.2.103.10 location.....	226
4.2.103.11 motd-banner	226
4.2.103.12 no	227
4.2.103.13 privilege level.....	227
4.2.103.14 width	228
4.2.104 lldp holdtime	228
4.2.105 lldp med datum	229
4.2.106 lldp med fast	229
4.2.107 lldp med location-tlv altitude	230
4.2.108 lldp med location-tlv elin-addr	230
4.2.109 lldp med location-tlv latitude	231
4.2.110 lldp med location-tlv longitude.....	231
4.2.111 lldp med media-vlan-policy.....	232
4.2.112 lldp reinit	233
4.2.113 lldp timer	234
4.2.114 lldp transmission-delay	234
4.2.115 logging host	235
4.2.116 logging level.....	235
4.2.117 logging on	236
4.2.118 loop-protect.....	236
4.2.119 loop-protect shutdown-time.....	237
4.2.120 loop-protect transmit-time	237
4.2.121 mac address-table aging-time	238
4.2.122 mac address-table static.....	238
4.2.123 mep <Instance> ais	239

4.2.124 mep <Instance> aps	240
4.2.125 mep <Instance> cc	240
4.2.126 mep <Instance> client domain	241
4.2.127 mep <Instance> client flow	242
4.2.128 mep <Instance> dm	243
4.2.129 mep <Instance> dm ns	244
4.2.130 mep <Instance> dm overflow-reset	244
4.2.131 mep <Instance> dm proprietary	245
4.2.132 mep <Instance> dm synchronized	245
4.2.133 mep <Instance> down	246
4.2.134 mep <Instance> lb	247
4.2.135 mep <Instance> lck	248
4.2.136 mep <Instance> level	248
4.2.137 mep <Instance> lm	249
4.2.138 mep <Instance> lt	250
4.2.139 mep <Instance> meg-id	250
4.2.140 mep <Instance> mep-id	251
4.2.141 mep <Instance> peer-mep-id	252
4.2.142 mep <Instance> performance-monitoring	252
4.2.143 mep <Instance> tst	253
4.2.144 mep <Instance> up	254
4.2.145 mep <Instance> vid	255
4.2.146 mep <Instance> voe	255
4.2.147 monitor destination	256
4.2.148 monitor source	256
4.2.149 mvr	257
4.2.150 mvr name <mvr_name> channel	257
4.2.151 mvr name <mvr_name> frame priority	258
4.2.152 mvr name <mvr_name> frame tagged	258
4.2.153 mvr name <mvr_name> igmp-address	259
4.2.154 mvr name <mvr_name> last-member-query-interval	259
4.2.155 mvr name <mvr_name> mode	260
4.2.156 mvr vlan <vlan_list>	260
4.2.157 mvr vlan <vlan_list> channel	261
4.2.158 mvr vlan <vlan_list> frame priority	261
4.2.159 mvr vlan <vlan_list> tagged	262
4.2.160 mvr vlan <vlan_list> igmp-address	263
4.2.161 mvr vlan <vlan_list> last-member-query-interval	263
4.2.162 mvr vlan <vlan_list> mode	264
4.2.163 mvr vlan <vlan_list> name	264
4.2.164 network-clock clk-source <clk-source> aneg-mode	265

4.2.165 no	265
4.2.166 ntp	266
4.2.167 ntp server	266
4.2.168 poe admin-mode enable	267
4.2.169 poe management mode	267
4.2.170 poe sequential enable	268
4.2.171 poe sequential interval	269
4.2.172 poe sequential rule	269
4.2.173 poe supply	270
4.2.174 poe temperature-protection enable	270
4.2.175 poe temperature-threshold	271
4.2.176 poe usage-threshold	271
4.2.177 poe-time-range	272
4.2.177.1 do	272
4.2.177.2 end	273
4.2.177.3 exit	273
4.2.177.4 no	274
4.2.177.5 periodic	274
4.2.177.6 reboot-only	275
4.2.178 port-security	276
4.2.179 port-security aging	276
4.2.180 port-security aging time	277
4.2.181 privilege	277
4.2.182 qos map cos-dscp	278
4.2.183 qos map dscp-classify	279
4.2.184 qos map dscp-cos	280
4.2.185 qos map dscp-egress-translation	282
4.2.186 qos map dscp-ingress-translation	283
4.2.187 qos qce	284
4.2.188 qos qce update	285
4.2.189 qos qce refresh	287
4.2.190 qos wred	287
4.2.191 radius-server attribute 32	288
4.2.192 radius-server attribute 4	289
4.2.193 radius-server attribute 95	289
4.2.194 radius-server deadtime	290
4.2.195 radius-server host	290
4.2.196 radius-server key	291
4.2.197 radius-server retransmit	292
4.2.198 radius-server timeout	292
4.2.199 rmon alarm	293

4.2.200 rmon event	294
4.2.201 sflow agent-ip	295
4.2.202 sflow collector-address	295
4.2.203 sflow collector-port.....	296
4.2.204 sflow max-datagram-size.....	296
4.2.205 sflow timeout	297
4.2.206 sfp temperature-threshold	297
4.2.207 snmp-server	298
4.2.208 snmp-server access	298
4.2.209 snmp-server community	299
4.2.210 snmp-server contact.....	300
4.2.211 snmp-server engine-id	300
4.2.212 snmp-server host.....	301
4.2.212.1 do	301
4.2.212.2 end	302
4.2.212.3 exit.....	302
4.2.212.4 host	303
4.2.212.5 no	304
4.2.212.6 informs	304
4.2.212.7 shutdown.....	305
4.2.212.8 traps	305
4.2.212.9 version.....	306
4.2.213 spanning-tree aggregation.....	307
4.2.213.1 do	307
4.2.213.2 end	308
4.2.213.3 exit.....	308
4.2.213.4 no	309
4.2.213.5 spanning-tree auto-edge	309
4.2.213.6 spanning-tree bpdu-guard	310
4.2.213.7 spanning-tree edge	310
4.2.213.8 spanning-tree link-type	311
4.2.213.9 spanning-tree mst <instance> cost.....	311
4.2.213.10 spanning-tree mst <instance> port-priority	312
4.2.213.11 spanning-tree restricted-role.....	312
4.2.213.12 spanning-tree restricted-tcn.....	313
4.2.214 switchport vlan mapping	313
4.2.215 tacacs-server deadtime	314
4.2.216 tacacs-server host	314
4.2.217 transport email authentication	315
4.2.218 transport email from.....	316
4.2.219 transport email smtp-server	316

4.2.220 transport email to	317
4.2.221 upnp	317
4.2.222 upnp advertising-duration	318
4.2.223 upnp ttl.....	318
4.2.224 username	319
4.2.225 vlan.....	320
4.2.225.1 do	320
4.2.225.2 end	321
4.2.225.3 exit.....	321
4.2.225.4 name	322
4.2.225.5 no	322
4.2.226 vlan ethertype s-custom-port	323
4.2.227 vlan protocol	323
4.2.228 voice vlan	324
4.2.229 voice vlan aging-time	325
4.2.230 voice vlan class	325
4.2.231 voice vlan oui.....	326
4.2.232 voice vlan vid.....	326
4.2.233 web privilege group	327
4.3 copy	328
4.3.1 copy.....	328
4.4 debug	328
4.4.1 debug	328
4.5 delete	329
4.5.1 delete.....	329
4.6 dir	330
4.6.1 dir	330
4.7 disable	330
4.7.1 disable.....	330
4.8 do	331
4.8.1 do	331
4.9 dot1x	332
4.9.1 dot1x initialize.....	332
4.10 enable	332
4.10.1 enable.....	332
4.11 erps	333
4.11.1 erps.....	333

4.12 exit	334
4.12.1 exit.....	334
4.13 firmware	334
4.13.1 firmware swap	334
4.13.2 firmware upgrade.....	335
4.14 ip	335
4.14.1 ip dhcp retry interface vlan	335
4.15 logout	336
4.15.1 logout.....	336
4.16 more	336
4.16.1 more	336
4.17 no	337
4.17.1 no	337
4.18 ping	338
4.18.1 ping ip	338
4.18.2 ping ipv6	339
4.19 reload	340
4.19.1 reload cold	340
4.19.2 reload defaults	340
4.20 send	341
4.20.1 send.....	341
4.21 show	342
4.21.1 show aaa	342
4.21.2 show access management	342
4.21.3 show access-list	343
4.21.4 show access-list	344
4.21.5 show access-list ace-status	346
4.21.6 show aggregation	347
4.21.7 show aggregation mode	347
4.21.8 show clock.....	348
4.21.9 show clock detail	349
4.21.10 show dot1x statistics.....	350
4.21.11 show dot1x status	351
4.21.12 show eps	352
4.21.13 show erps	353
4.21.14 show evc	354
4.21.15 show evc statistics.....	355

4.21.16 show green-ethernet.....	355
4.21.17 show green-ethernet energy-detect.....	356
4.21.18 show green-ethernet short-reach.....	356
4.21.19 show history	357
4.21.20 show interface <port_type> <port_type_list> capabilities	357
4.21.21 show interface <port_type> <port_type_list> statistics	358
4.21.22 show interface <port_type> <port_type_list> status	359
4.21.23 show interface <port_type> <port_list> switchport.....	359
4.21.24 show interface <port_type> <port_type_list> veriphy	360
4.21.25 show interface <port_type> <port_type_list> veriphy	361
4.21.26 show interface vlan.....	361
4.21.27 show ip arp	362
4.21.28 show ip arp inspection	363
4.21.29 show ip arp inspection	363
4.21.30 show ip arp inspection entry	364
4.21.31 show ip dhcp detailed statistics	365
4.21.32 show ip dhcp excluded-address	366
4.21.33 show ip dhcp pool.....	367
4.21.34 show ip dhcp relay.....	368
4.21.35 show ip dhcp server.....	368
4.21.36 show ip dhcp server binding (GG)	369
4.21.37 show ip dhcp server declined-ip (GG)	370
4.21.38 show ip dhcp server statistics	370
4.21.39 show ip dhcp snooping.....	371
4.21.40 show ip dhcp snooping table	372
4.21.41 show ip http server secure status	373
4.21.42 show ip igmp snooping.....	373
4.21.43 show ip igmp snooping mrouter.....	374
4.21.44 show ip interface brief.....	375
4.21.45 show ip name-server	375
4.21.46 show ip route	376
4.21.47 show ip source binding.....	376
4.21.48 show ip ssh.....	377
4.21.49 show ip statistics.....	377
4.21.50 show ip verify source	379
4.21.51 show ipmc profile.....	380
4.21.52 show ipmc range	380
4.21.53 show ipv6 interface.....	381
4.21.54 show ipv6 mld snooping	382
4.21.55 show ipv6 mld snooping mrouter.....	383
4.21.56 show ipv6 neighbor.....	383

4.21.57 show ipv6 route	384
4.21.58 show ipv6 statistics	385
4.21.59 show lacp	387
4.21.60 show line	387
4.21.61 show lldp med media-vlan-policy	388
4.21.62 show lldp med remote-device	389
4.21.63 show lldp neighbors	389
4.21.64 show lldp statistics	390
4.21.65 show logging	390
4.21.66 show loop-protect	391
4.21.67 show mac address-table	392
4.21.68 show mep	393
4.21.69 show mvr	394
4.21.70 show network-clock	395
4.21.71 show ntp status	395
4.21.72 show platform phy	396
4.21.73 show platform phy failover	397
4.21.74 show platform phy id	397
4.21.75 show platform phy status	398
4.21.76 show port-security port	398
4.21.77 show port-security switch	399
4.21.78 show privilege	400
4.21.79 show pvlan	400
4.21.80 show pvlan isolation	401
4.21.81 show qos	401
4.21.82 show radius-server	404
4.21.83 show rmon alarm	404
4.21.84 show rmon event	405
4.21.85 show rmon history	406
4.21.86 show rmon statistics	406
4.21.87 show running-config	407
4.21.88 show snmp	409
4.21.89 show snmp access	411
4.21.90 show snmp community v3	412
4.21.91 show snmp host	412
4.21.92 show snmp mib context	413
4.21.93 show snmp mib ifmib ifIndex	415
4.21.94 show snmp security-to-group	417
4.21.95 show snmp user	418
4.21.96 show snmp view	418
4.21.97 show spanning-tree	419

4.21.98 show switchport forbidden	420
4.21.99 show tacacs-server.....	421
4.21.100 show terminal	421
4.21.101 show upnp	422
4.21.102 show users	423
4.21.103 show version	424
4.21.104 show vlan	425
4.21.105 show vlan ip-subnet.....	425
4.21.106 show vlan mac.....	426
4.21.107 show vlan protocol.....	426
4.21.108 show voice vlan	428
4.21.109 show web privilege group	428
4.22 terminal.....	430
4.22.1 terminal editing	430
4.22.2 terminal exec-timeout	430
4.22.3 terminal history size.....	431
4.22.4 terminal length	431
4.22.5 terminal width	432

Chapter 1 COMMAND LINE INTERFACE

1.1 Accessing the CLI

When accessing the management interface for the switch over a direct connection to the server's console port, or via a Telnet connection, the switch can be managed by entering command keywords and parameters at the prompt. Using the switch's command-line interface (CLI) is very similar to entering commands on a UNIX system.

This chapter describes how to use the Command Line Interface (CLI).

1.2 Command Line Modes

The CLI groups all the commands in appropriate modes according to the nature of the command. A sample of the CLI command modes are described below. Each of the command modes supports specific software commands.

Mode-based Command Hierarchy

The **Command Line Interface (CLI)** groups all the commands in appropriate modes by the nature of the commands. Examples of the CLI command modes are described below. Each of the command modes supports specific switch's commands.

The CLI Command Modes table captures the command modes, the prompts visible in that mode and the exit method from that mode.

Command Mode	Access Method	Prompt	Exit or Access Previous Mode
User Mode	This is the first level of access. Perform basic tasks and list system information.	COMMAND>	Enter Logout command
Privileged Mode	From the User Mode, enter the enable command.	Switch#	To exit to the User Mode, enter exit or Logout.
Global Config Mode	From the Privileged Mode, enter the configuration command.	Switch (Config)#	To exit to the Privileged Mode, enter the exit command.
Interface Config Mode	From the Global Config mode, enter the interface <port#> command.	Switch (Interface <port#>)#	To exit to the Global Config mode, enter exit.

Table 4-1 CLI Command Modes

The CLI is divided into various modes. The commands in one mode are not available until the operator switches to that particular mode. The commands available to the operator at any point in time depend upon the mode. Entering a question mark (?) at the CLI prompt, and displays a list of the available commands and descriptions of the commands.

The CLI provides the following modes:

■ User Mode

When the operator logs into the CLI, the User Mode is the initial mode. The User Mode contains a limited set of commands. The command prompt shown at this level is:

Command Prompt: switch>

■ Privileged Mode

To have access to the full suite of commands, the operator must enter the Privileged Mode. The Privileged Mode requires password authentication. From Privileged Mode, the operator can issue any Exec command to enter the Global Configuration mode. The command prompt shown at this level is:

Command Prompt: switch#

■ Global Config Mode

This mode permits the operator to make modifications to the running configuration. General setup commands are grouped in this mode. From the Global Configuration mode, the operator can enter the Interface Configuration mode. The command prompt at this level is:

Command Prompt: switch(Config)#

From the Global Config mode, the operator may enter the following configuration modes:

■ Interface Config Mode

Many features are enabled for a particular interface. The Interface commands enable or modify the operation of an interface. In this mode, a physical port is set up for a specific logical connection operation. The command prompt at this level is:

Command Prompt: Switch(Interface <port#>)#

1.3 Requirements

- **Workstations** running Windows XP/Vista/7/8/, Windows 2003/2008, MAC OS X or later, Linux, UNIX, or other platforms are compatible with TCP/IP protocols.
- Workstations are installed with Ethernet NIC (Network Interface Card)
- **Serial Port** Connection (Terminal)
 - The above Workstations come with **COM Port** (DB9) or **USB-to-RS-232** converter.
 - The above Workstations have been installed with **terminal emulator**, such as Hyper Terminal included in Windows XP/2003.
 - **Serial cable** -- one end is attached to the RS-232 serial port, while the other end to the console port of the Managed Switch.
- **Ethernet Port** Connection
 - Network cables -- Use standard network (UTP) cables with RJ-45 connectors.
 - The above PC is installed with Web Browser and JAVA runtime environment plug-in.

Chapter 2 CONSOLE CLI MANAGEMENT

2.1 Terminal Setup

To configure the system, connect a serial cable to a **COM port** on a PC or notebook computer and to RJ-45 type of serial (console) port of the Managed Switch.

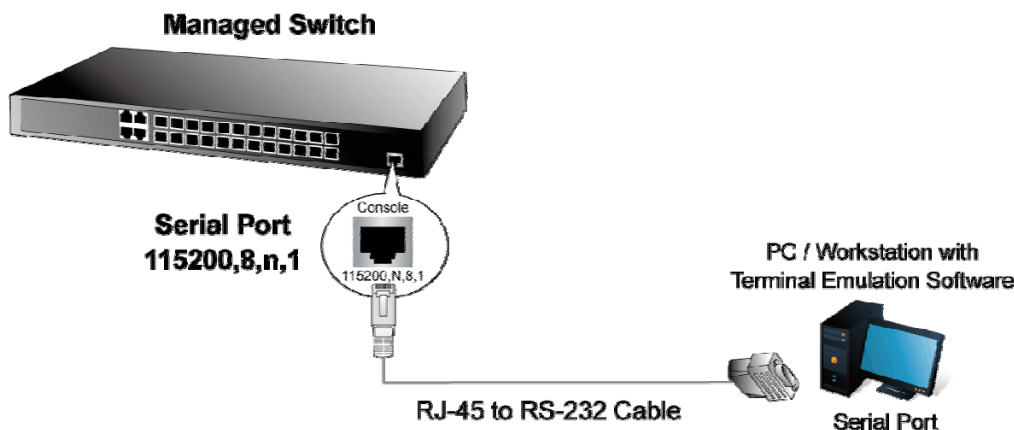

Figure 2-1 Managed Switch Console Connectivity

The console port of the Managed Switch is a RJ-45 type, RS-232 serial port connector. It is an interface for connecting a terminal directly. Through the console port, it provides rich diagnostic information including IP Address setting, factory reset, port management, link status and system setting. Users can use the attached RS-232 cable in the package and connect to the console port on the device. After the connection, users can run any terminal emulation program (Hyper Terminal, ProComm Plus, Telix, Winterm and so on) to enter the startup screen of the device.

GS-5220-16S8C Front Panel

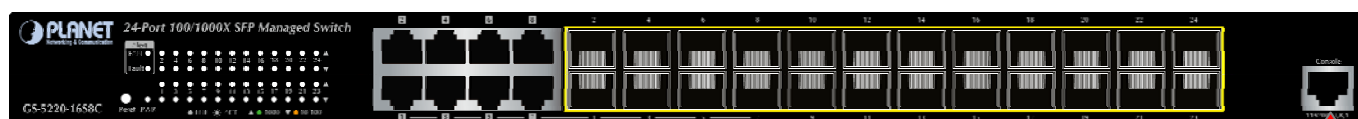

Figure 2-2: Front Panels of GS-5220-16S8C

Console port

GS-5220-16S8CR Front Panel



Figure 2-3: Rear Panel of GS-5220-16S8CR

Console port

A terminal program is required to make the software connection to the Managed Switch. Windows' **Hyper Terminal** program may be a good choice. The Hyper Terminal can be accessed from the **Start** menu.

1. Click **START**, then **Programs, Accessories** and then **Hyper Terminal**.
2. When the following screen appears, make sure that the COM port should be configured as:

◆ Baud	: 115200
◆ Data bits	: 8
◆ Parity	: None
◆ Stop bits	: 1
◆ Flow control	: None



Figure 2-3 Hyper Terminal COM Port Configuration

You can change these settings, if desired, after you log on. This management method is often preferred because you can remain connected and monitor the system during system reboots. Also, certain error messages are sent to the serial port, regardless of the interface through which the associated action was initiated. A Macintosh or PC attachment can use any terminal-emulation program for connecting to the terminal serial port. A workstation attachment under UNIX can use an emulator such as TIP.

2.2 Logon to the Console

Once the terminal is connected to the device, power on the Managed Switch, and the terminal will display “running testing procedures”. Then, the following message asks to log-in user name and password. The factory default user name and password are shown as follows and the login screen in [Figure 3-1](#) appears.

```
Username: admin
Password: admin
```

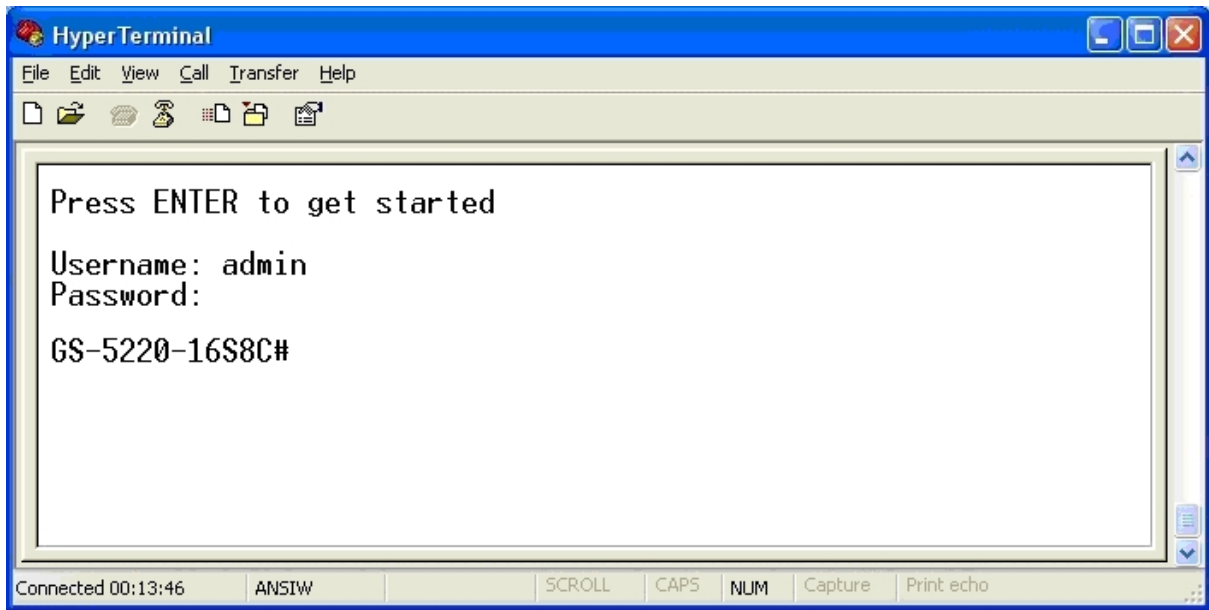

Figure 3-1: Managed Switch Console Login Screen

The user can now enter commands to manage the Managed Switch. For a detailed description of the commands, please refer to the following chapters.



1. For security reason, please change and memorize the new password after this first setup.
2. Only accept command in lowercase letter under console interface.

2.3 Configuring IP Address

The Managed Switch is shipped with default IP address shown below.

```
IP Address: 192.168.0.100
Subnet Mask: 255.255.255.0
```

To check the current IP address or modify a new IP address for the Switch, please use the procedures as follows:

■ Show the current IP Address

1. At the “#” prompt, enter “show ip interface brief”.
2. The screen displays the current IP address and Subnet Mask as shown in Figure 3-2.

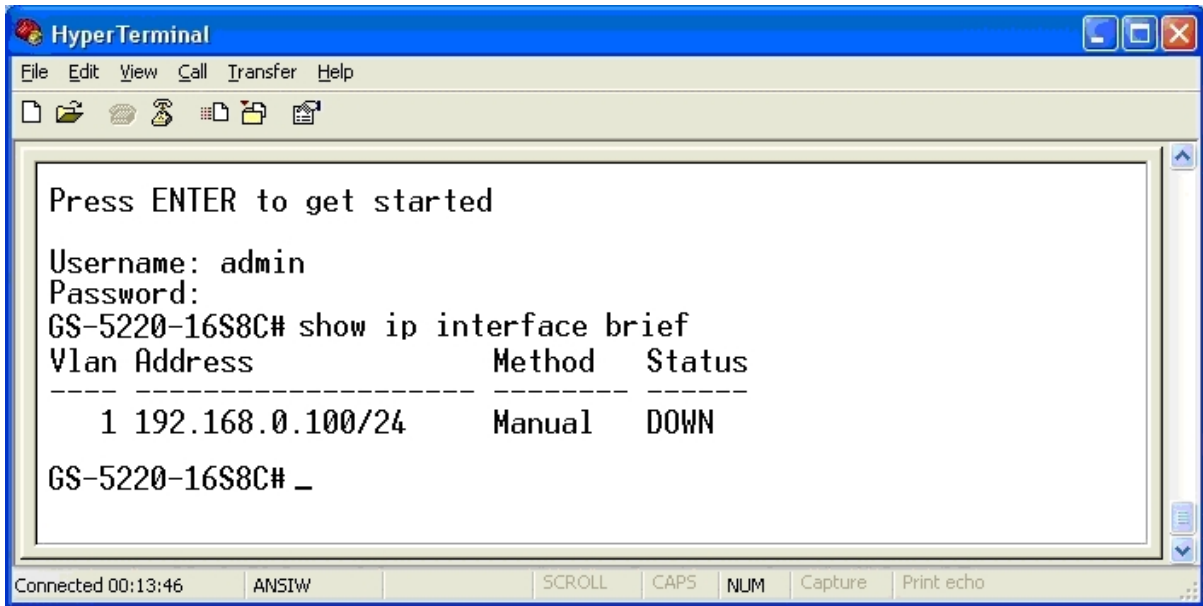

Figure 3-2: IP Information Screen

■ Configuring IP Address

3. At the “#” prompt, enter the following command and press <Enter>. As shown in Figure 3-3.

```

# configure terminal
(config)# interface vlan 1
(config-if-vlan)# ip address 192.168.1.100 255.255.255.0
    
```

The previous command would apply the following settings for the Managed Switch.

IP Address: **192.168.1.100**

Subnet Mask: **255.255.255.0**

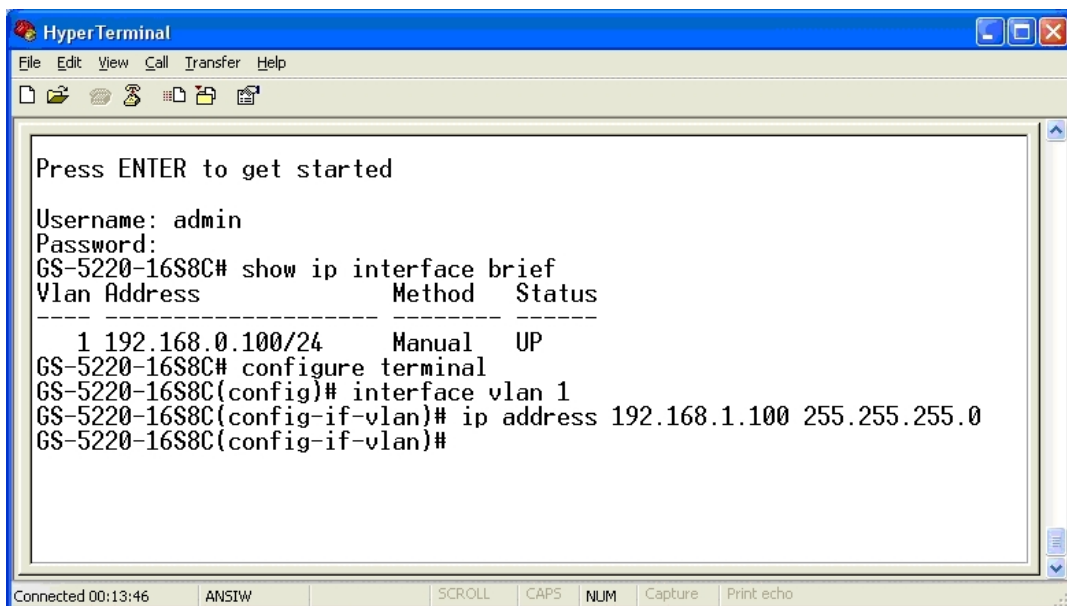

Figure 3-3: Configuring IP Address Screen

4. Repeat step 1 to check if the IP address is changed.

■ Store current switch configuration

5. At the “#” prompt, enter the following command and press <Enter>.

```
# copy running-config startup-config
```

```

HyperTerminal
File Edit View Call Transfer Help
[Icons]
Username: admin
Password:
GS-5220-16S8C# show ip interface brief
Vlan Address          Method  Status
-----
 1 192.168.0.100/24    Manual  UP
GS-5220-16S8C# configure terminal
GS-5220-16S8C(config)# interface vlan 1
GS-5220-16S8C(config-if-vlan)# ip address 192.168.1.100 255.255.255.0
GS-5220-16S8C(config-if-vlan)# exit
GS-5220-16S8C(config)# exit
GS-5220-16S8C# copy running-config startup-config
Building configuration...
% Saving 2103 bytes to flash:startup-config
GS-5220-16S8C#
GS-5220-16S8C#
Connected 00:13:46  ANSIW  SCROLL  CAPS  NUM  Capture  Print echo
    
```

Figure 3-4: Saving Current Configuration Command Screen

If the IP is successfully configured, the Managed Switch will apply the new IP address setting immediately. You can access the Web interface of the Managed Switch through the new IP address.



If you are not familiar with the console command or the related parameter, enter “ ? ” anytime in console to get the help description.

Chapter 3 TELNET CLI MANAGEMENT

3.1 Telnet Login

The Managed Switch also supports telnet for remote management. The switch asks for user name and password for remote login when using telnet, please use “**admin**” for username & password.

Default IP address: **192.168.0.100**

Username: **admin**

Password: **admin**

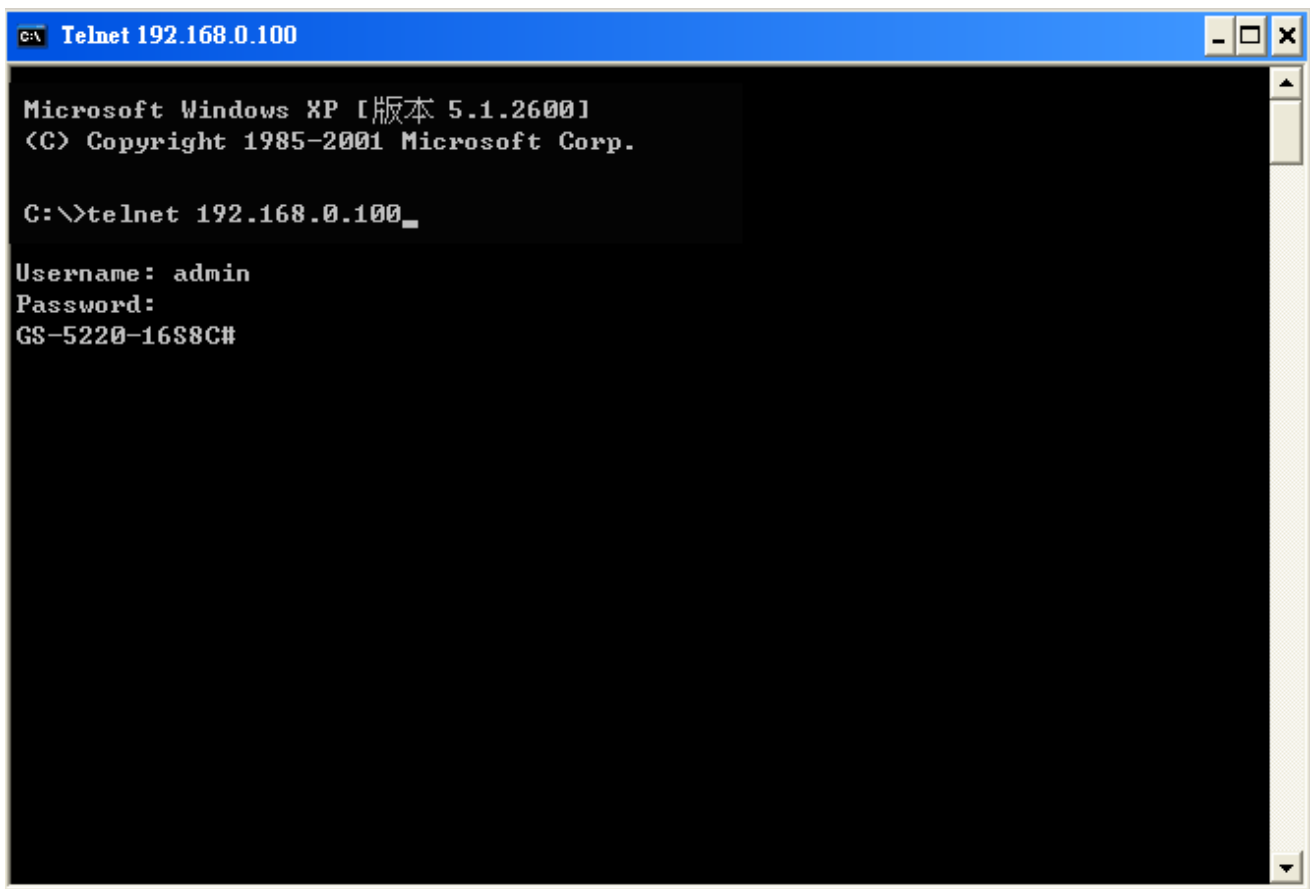

Figure 4-1 Managed Switch Telnet Login Screen

Chapter 4 Commands for CLI Configuration

Before read the Command for CLI configuration, please refer to the table below and know what the main command type for which models is.

Command Type	Models
PoE	WGSW-48040HP / XGSW-28040HP
10G	XGSW-28040HP / MGSW-28240F
ERPS	XGSW-28040HP / MGSW-28240F / MGSD-10080F
MEP	XGSW-28040HP / MGSW-28240F / MGSD-10080F
EVC	None
GVRP	None
sflow	None
Link OAM	None

4.1 clear

4.1.1 clear access management statistics

Command:

```
clear access management statistics
```

Default:

N/A

Usage Guide:

To clear the **access management statistics**.

Example:

To clear the Switch's **access management statistics**.

```
Switch# clear access management statistics
```

4.1.2 clear access-list ace statistics

Command:

```
clear access-list ace statistics
```

Default:

N/A

Usage Guide:

To clear the **Access list entry statistics**.

Example:

To clear the Switch's **Access list entry statistics**.

```
Switch# clear access-list ace statistics
```

4.1.3 clear dot1x statistics interface

Command:

```
clear dot1x statistics interface GigabitEthernet | 10GigabitEthernet
```

Default:

N/A

Usage Guide:

To clear the **dot1x statistics**.

Example:

To clear the Switch's **GigabitEthernet 1/25 dot1x statistics**.

```
Switch# clear dot1x statistics interface GigabitEthernet 1/25
```

4.1.4 clear eps

Command:

```
clear eps <Inst : uint>
```

<Inst : uint> The EPS instance number.

Default:

N/A

Usage Guide:

To clear the **EPS instance number**.

4.1.5 clear erps

Command:

```
clear erps < ERPS group numbers > statistics
```

Default:

N/A

Usage Guide:

To clear the **ERPS group numbers statistics**.

Example:

To clear the Switch's **ERPS group 1 statistics**.

```
Switch# # clear erps 1 statistics
```

4.1.6 clear erps statistics

Command:

```
clear erps statistics
```

Default:

N/A

Usage Guide:

To clear the **ERPS statistics**.

Example:

To clear the Switch's **ERPS statistics**.

```
Switch# clear erps statistics
```

4.1.7 clear evc statistics

Command:

```
clear evc statistics
```

Default:

N/A

Usage Guide:

To clear the **Ethernet Virtual Connections statistics**.

Example:

To clear the Switch's **Ethernet Virtual Connections statistics**.

```
Switch# clear evc statistics
```

4.1.8 clear ip arp

Command:

```
clear ip arp
```

Default:

N/A

Usage Guide:

To clear the **ARP cache**.

Example:

To clear the Switch's **ARP cache**.

```
Switch# clear ip arp
```

4.1.9 clear ip dhcp detailed statistics all

Command:

```
clear ip dhcp detailed statistics all
```

Default:

N/A

Usage Guide:

To clear the **DHCP detailed statistics** for all.

Example:

To clear the Switch's **DHCP detailed statistics** for all.

```
Switch# clear ip dhcp detailed statistics all
```

4.1.10 clear ip dhcp detailed statistics client

Command:

```
clear ip dhcp detailed statistics client
```

Default:

N/A

Usage Guide:

To clear the **DHCP client statistics**.

Example:

To clear the Switch's **DHCP client statistics**.

```
Switch# clear ip dhcp detailed statistics client
```

4.1.11 clear ip dhcp detailed statistics helper

Command:

```
clear ip dhcp detailed statistics helper
```

Default:

N/A

Usage Guide:

To clear the **DHCP normal L2 or L3 forward statistics**.

Example:

To clear the Switch's **DHCP normal L2 or L3 forward statistics**.

```
Switch# clear ip dhcp detailed statistics helper
```

4.1.12 clear ip dhcp detailed statistics server

Command:

```
clear ip dhcp detailed statistics server
```

Default:

N/A

Usage Guide:

To clear the **DHCP server statistics**.

Example:

To clear the Switch's **DHCP server statistics**.

```
Switch# clear ip dhcp detailed statistics server
```

4.1.13 clear ip dhcp detailed statistics snooping

Command:

```
clear ip dhcp detailed statistics snooping
```

Default:

N/A

Usage Guide:

To clear the **DHCP snooping statistics**.

Example:

To clear the Switch's **DHCP normal L2 or L3 forward statistics**.

```
Switch# clear ip dhcp detailed statistics snooping
```

4.1.14 clear ip dhcp relay statistics

Command:

```
clear ip dhcp relay statistics
```

Default:

N/A

Usage Guide:

To clear the **DHCP relay statistics**.

Example:

To clear the Switch's **DHCP relay statistics**.

```
Switch# clear ip dhcp relay statistics
```

4.1.15 clear ip dhcp server binding

Command:

```
clear ip dhcp server binding <IP>
```

<IP> A.B.C.D

Default:

N/A

Usage Guide:

To clear the **DHCP server binding cache**.

Example:

To clear the Switch's **DHCP server(192.168.0.100) binding cache**.

```
Switch# clear ip dhcp server binding 192.168.0.100
```

4.1.16 clear ip dhcp server binding automatic

Command:

```
clear ip dhcp server binding automatic
```

Default:

N/A

Usage Guide:

To clear the **DHCP automatic bindings cache**.

Example:

To clear the Switch's **DHCP automatic bindings cache**.

```
Switch# clear ip dhcp server binding automatic
```

4.1.17 clear ip dhcp server binding expired

Command:

```
clear ip dhcp server binding expired
```

Default:

N/A

Usage Guide:

To clear the **DHCP expired bindings for free**.

Example:

To clear the Switch's **DHCP expired bindings for free**.

```
Switch# clear ip dhcp server binding expired
```

4.1.18 clear ip dhcp server binding manual

Command:

```
clear ip dhcp server binding manual
```

Default:

N/A

Usage Guide:

To clear the **DHCP server manual binding cache**.

Example:

To clear the Switch's **DHCP server manual binding cache**.

```
Switch# clear ip dhcp server binding manual
```

4.1.19 clear ip igmp snooping statistics

Command:

```
clear ip igmp snooping statistics
```

Default:

N/A

Usage Guide:

To clear the **IGMP snooping statistics**.

Example:

To clear the Switch's **IGMP snooping statistics**.

```
Switch# clear ip igmp snooping statistics
```

4.1.20 clear ip igmp snooping vlan

Command:

```
clear ip igmp snooping vlan <vlan_list> statistics
```

<vlan_list> VLAN identifier(s): VID

Default:

N/A

Usage Guide:

To clear the **IGMP snooping vlan <vlan_list>** statistics.

Example:

To clear the Switch's **IGMP snooping vlan 1** statistics.

```
Switch# clear ip igmp snooping vlan 1 statistics
```

4.1.21 clear ip statistics icmp icmp-msg

Command:

```
clear ip statistics icmp icmp-msg <Type : 0~255>
```

<Type : 0~255> ICMP message type ranges from 0 to 255

Default:

N/A

Usage Guide:

To clear the **IPv4 ICMP traffic for designated message type**.

Example:

To clear the Switch's **IPv4 ICMP traffic for designated message type 0**.

```
Switch# clear ip statistics icmp icmp-msg 0
```

4.1.22 clear ip statistics icmp interface vlan

Command:

```
clear ip statistics icmp interface vlan <vlan_list>
```

<vlan_list> VLAN identifier(s): VID

Default:

N/A

Usage Guide:

To clear the **IPv4 interface/ICMP statistics** for specific VLAN.

Example:

To clear the Switch's **IP interface/ICMP statistics** for specific VLAN 1.

```
Switch# clear ip statistics icmp interface vlan 1
```

4.1.23 clear ip statistics system icmp icmp-msg

Command:

```
clear ip statistics system icmp icmp-msg <Type : 0~255>
```

<Type : 0~255> ICMP message type ranges from 0 to 255

Default:

N/A

Usage Guide:

To clear the **IPv4 ICMP statistics** for specific **ICMP message type**.

Example:

To clear the Switch's **IPv4 ICMP statistics** for specific **ICMP message type 0**.

```
Switch# clear ip statistics system icmp icmp-msg 0
```

4.1.24 clear ip statistics system icmp interface vlan

Command:

```
clear ip statistics system icmp interface vlan
```

<vlan_list> VLAN identifier(s): VID

Default:

N/A

Usage Guide:

To clear the **IPv4 ICMP interface statistics** for specific VLAN.

Example:

To clear the Switch's **IPv4 ICMP interface statistics** for specific VLAN 1.

```
Switch# clear ip statistics system icmp interface vlan 1
```

4.1.25 clear ipv6 mld snooping statistics

Command:

```
clear ipv6 mld snooping statistics
```

Default:

N/A

Usage Guide:

To clear the **ipv6 mld snooping statistics**.

Example:

To clear the Switch's **ipv6 mld snooping statistics**.

```
Switch# clear ipv6 mld snooping statistics
```

4.1.26 clear ipv6 mld snooping vlan

Command:

```
clear ipv6 mld snooping vlan <vlan_list> statistics
```

<vlan_list> VLAN identifier(s): VID

Default:

N/A

Usage Guide:

To clear the **ipv6 mld snooping statistics** for specific VLAN.

Example:

To clear the Switch's **ipv6 mld snooping statistics** for specific VLAN 1.

```
Switch# clear ipv6 mld snooping vlan 1 statistics
```

4.1.27 clear ipv6 neighbors

Command:

```
clear ipv6 neighbors
```

Default:

N/A

Usage Guide:

To clear the **ipv6 neighbors**.

Example:

To clear the Switch's **ipv6 neighbors**.

```
Switch# clear ipv6 neighbors
```

4.1.28 clear ipv6 statistics icmp icmp-msg

Command:

```
clear ipv6 statistics icmp icmp-msg <Type : 0~255>
```

<Type : 0~255> ICMP message type ranges from 0 to 255

Default:

N/A

Usage Guide:To clear the **IPv6 ICMP traffic for designated message type**.**Example:**To clear the Switch's **IPv6 ICMP traffic for designated message type 0**.

```
Switch# clear ipv6 statistics icmp icmp-msg 0
```

4.1.29 clear ipv6 statistics icmp interface vlan

Command:

```
clear ipv6 statistics icmp interface vlan <vlan_list>
```

<vlan_list> VLAN identifier(s): VID

Default:

N/A

Usage Guide:To clear the **IPv6 interface/ICMP statistics** for specific VLAN.**Example:**To clear the Switch's **IPv6 interface/ICMP statistics** for specific VLAN 1.

```
Switch# clear ipv6 statistics icmp interface vlan 1
```

4.1.30 clear ipv6 statistics system icmp icmp-msg

Command:

```
clear ipv6 statistics system icmp icmp-msg <Type : 0~255>
```

<Type : 0~255> ICMP message type ranges from 0 to 255

Default:

N/A

Usage Guide:

To clear the **IPv6 ICMP statistics** for specific **ICMP message type**.

Example:

To clear the Switch's **IPv6 ICMP statistics** for specific **ICMP message type 0**.

```
Switch# clear ipv6 statistics system icmp icmp-msg 0
```

4.1.31 clear ipv6 statistics system icmp interface vlan

Command:

```
clear ipv6 statistics system icmp interface vlan
```

<vlan_list> VLAN identifier(s): VID

Default:

N/A

Usage Guide:

To clear the **IPv6 ICMP interface statistics** for specific VLAN.

Example:

To clear the Switch's **IPv6 ICMP interface statistics** for specific VLAN 1.

```
Switch# clear ipv6 statistics system icmp interface vlan 1
```

4.1.32 clear lacp statistics

Command:

```
clear lacp statistics
```

Default:

N/A

Usage Guide:

To clear the **lACP statistics**.

Example:

To clear the Switch's **lACP statistics**.

```
Switch# clear lacp statistics
```

4.1.33 clear lldp statistics

Command:

```
clear lldp statistics
```

Default:

N/A

Usage Guide:

To clear the **lldp statistics**.

Example:

To clear the Switch's **lldp statistics**.

```
Switch# clear lldp statistics
```

4.1.34 clear logging error info

Command:

```
clear logging error info
```

Default:

N/A

Usage Guide:

To clear the **logging error info**.

Example:

To clear the Switch's **logging error info**.

```
Switch# clear logging error info
```

4.1.35 clear logging error warning

Command:

```
clear logging error warning
```

Default:

N/A

Usage Guide:

To clear the **logging error warning**.

Example:

To clear the Switch's **logging error warning**.

```
Switch# clear logging error warning
```

4.1.36 clear logging info error

Command:

```
clear logging info error
```

Default:

N/A

Usage Guide:

To clear the **logging info error**.

Example:

To clear the Switch's **logging info error**.

```
Switch# clear logging info error
```

4.1.37 clear logging info warning

Command:

```
clear logging info warning
```

Default:

N/A

Usage Guide:

To clear the **logging info warning**.

Example:

To clear the Switch's **logging info warning**.

```
Switch# clear logging info warning
```

4.1.38 clear logging warning error

Command:

```
clear logging warning error
```

Default:

N/A

Usage Guide:

To clear the **logging warning error**.

Example:

To clear the Switch's **logging warning error**.

```
Switch# clear logging warning error
```

4.1.39 clear logging warning info

Command:

```
clear logging warning info
```

Default:

N/A

Usage Guide:

To clear the **logging warning info**.

Example:

To clear the Switch's **logging warning info**.

```
Switch# clear logging warning info
```

4.1.40 clear mac address-table

Command:

```
clear mac address-table
```

Default:

N/A

Usage Guide:

To clear the **mac address-table**.

Example:

To clear the Switch's **mac address-table**.

```
Switch# clear mac address-table
```

4.1.41 clear mep

Command:

```
clear mep <Inst : uint>
```

<Inst : uint> The MEP instance.

Default:

N/A

Usage Guide:

To clear the **MEP instance profiles**.

4.1.42 clear mvr name

Command:

```
clear mvr name <MvrName : word16>
```

<MvrName : word16> MVR multicast VLAN name

Default:

N/A

Usage Guide:

To clear the **mvr name profiles**.

4.1.43 clear mvr statistics

Command:

```
clear mvr statistics
```

Default:

N/A

Usage Guide:

To clear the **mvr statistics**.

Example:

To clear the Switch's **mvr statistics**.

```
Switch# clear mvr statistics
```

4.1.44 clear mvr vlan

Command:

```
clear mvr vlan <vlan_list> statistics
```

<vlan_list> MVR multicast VLAN list

Default:

N/A

Usage Guide:

To clear the **mvr vlan statistics** for specific VLAN.

Example:

To clear the Switch's **mvr vlan statistics** for specific VLAN 1.

```
Switch# clear mvr vlan 1 statistics
```

4.1.45 clear network-clock clk-source

Command:

```
clear network-clock clk-source <clk-source : 1-2>
```

<clk-source : 1-2> Clock source number

Default:

N/A

Usage Guide:

To clear the **ERPS WTR timer** for a specific profile.

Example:

To clear the Switch's **ERPS WTR timer** for a specific profile 1.

```
Switch# clear network-clock clk-source 1
```

4.1.46 clear spanning-tree detected-protocols interface *

Command:

```
clear spanning-tree detected-protocols interface *
```

Default:

N/A

Usage Guide:

To clear the **spanning-tree detected-protocols** for all.

Example:

To clear the Switch's **spanning-tree detected-protocols** for all.

```
Switch# clear spanning-tree detected-protocols interface *
```

4.1.47 clear spanning-tree detected-protocols interface *

Command:

```
clear spanning-tree detected-protocols interface *
```

Default:

N/A

Usage Guide:

To clear the **spanning-tree detected-protocols** for all.

Example:

To clear the Switch's **spanning-tree detected-protocols** for all.

```
Switch# clear spanning-tree detected-protocols interface *
```

4.1.48 clear spanning-tree detected-protocols interface

GigabitEthernet

Command:

```
clear spanning-tree detected-protocols interface GigabitEthernet <PORT_LIST>
```

<PORT_LIST> Port list in X/X-XX

Default:

N/A

Usage Guide:

To clear the **spanning-tree detected-protocols** for specific **GigabitEthernet port**.

Example:

To clear the Switch's **spanning-tree detected-protocols** for specific **GigabitEthernet 1/1**.

```
Switch# clear spanning-tree detected-protocols interface GigabitEthernet 1/1
```

4.1.49 clear spanning-tree detected-protocols interface 10GigabitEthernet

Command:

```
clear spanning-tree detected-protocols interface 10GigabitEthernet <PORT_LIST>
```

<PORT_LIST> Port list in X/X-XX

Default:

N/A

Usage Guide:

To clear the **spanning-tree detected-protocols** for specific **10GigabitEthernet** port.

Example:

To clear the Switch's **spanning-tree detected-protocols** for specific **10GigabitEthernet 1/1**.

```
Switch# clear spanning-tree detected-protocols interface 10GigabitEthernet 1/1
```

4.1.50 clear spanning-tree statistics interface *

Command:

```
clear spanning-tree statistics interface *
```

Default:

N/A

Usage Guide:

To clear the **spanning-tree statistics** for all.

Example:

To clear the Switch's **spanning-tree statistics** for all.

```
Switch# clear spanning-tree statistics interface *
```

4.1.51 clear spanning-tree statistics interface GigabitEthernet

Command:

```
clear spanning-tree statistics interface GigabitEthernet <PORT_LIST>
```

<PORT_LIST> Port list in X/X-XX

Default:

N/A

Usage Guide:

To clear the **spanning-tree statistics** for specific **GigabitEthernet port**.

Example:

To clear the Switch's **spanning-tree statistics** for specific **GigabitEthernet 1/1**.

```
Switch# clear spanning-tree statistics interface GigabitEthernet 1/1
```

4.1.52 clear spanning-tree statistics interface 10GigabitEthernet

Command:

```
clear spanning-tree statistics interface 10GigabitEthernet <PORT_LIST>
```

<PORT_LIST> Port list in X/X-XX

Default:

N/A

Usage Guide:

To clear the **spanning-tree statistics** for specific **10GigabitEthernet port**.

Example:

To clear the Switch's **spanning-tree statistics** for specific **10GigabitEthernet 1/1**.

```
Switch# clear spanning-tree statistics interface 10GigabitEthernet 1/1
```

4.1.53 clear statistics *

Command:

```
clear statistics *
```

Default:

N/A

Usage Guide:

To clear the **statistics** for all.

Example:

To clear the Switch's **statistics** for all.

```
Switch# clear statistics *
```

4.1.54 clear statistics GigabitEthernet

Command:

```
clear statistics GigabitEthernet <PORT_LIST>
```

<PORT_LIST> Port list in X/X-XX

Default:

N/A

Usage Guide:

To clear the **statistics** for specific **GigabitEthernet port**.

Example:

To clear the Switch's **statistics** for specific **GigabitEthernet 1/1**.

```
Switch# clear statistics GigabitEthernet 1/1
```

4.1.55 clear statistics 10GigabitEthernet

Command:

```
clear statistics 10GigabitEthernet <PORT_LIST>
```

<PORT_LIST> Port list in X/X-XX

Default:

N/A

Usage Guide:

To clear the **statistics** for specific **10GigabitEthernet port**.

Example:

To clear the Switch's **statistics** for specific **10GigabitEthernet 1/1**.

```
Switch# clear statistics 10GigabitEthernet 1/1
```

4.2 configure terminal

4.2.1 aaa authentication login console local

Command:

```
aaa authentication login console local
```

Default:

console : local

Usage Guide:

To authenticate the **local** account via **console** only.

Example:

To authenticate the **local** account via **console**.

```
Switch# configure terminal  
Switch (config)# aaa authentication login console local
```

4.2.2 aaa authentication login console radius

Command:

```
aaa authentication login console radius
```

Default:

console : local

Usage Guide:

To authenticate the **radius** account via **console** only.

Example:

To authenticate the **local** and **radius** account via **console**.

```
Switch# configure terminal  
Switch (config)# aaa authentication login console local radius
```

4.2.3 aaa authentication login console tacacs

Command:

```
aaa authentication login console tacacs
```

Default:

console : local

Usage Guide:

To authenticate the **tacacs** account via **console** only.

Example:

To authenticate the **local** and **radius** and **tacacs** account via **console**.

```
Switch# configure terminal  
Switch (config)# aaa authentication login console local radius tacacs
```

4.2.4 aaa authentication login http local

Command:

```
aaa authentication login http local
```

Default:

http : local

Usage Guide:

To authenticate the **local** account via **http** only.

Example:

To authenticate the **local** account via **http**.

```
Switch# configure terminal  
Switch (config)# aaa authentication login http local
```

4.2.5 aaa authentication login http radius

Command:

```
aaa authentication login http radius
```

Default:

http : local

Usage Guide:

To authenticate the **radius** account via **http** only.

Example:

To authenticate the **local** and **radius** account via **http**.

```
Switch# configure terminal
Switch (config)# aaa authentication login http local radius
```

4.2.6 aaa authentication login http tacacs

Command:

```
aaa authentication login http tacacs
```

Default:

http : local

Usage Guide:

To authenticate the **tacacs** account via **http** only.

Example:

To authenticate the **local** and **radius** and **tacacs** account via **http**.

```
Switch# configure terminal
Switch (config)# aaa authentication login http local radius tacacs
```

4.2.7 aaa authentication login ssh local

Command:

```
aaa authentication login ssh local
```

Default:

ssh : local

Usage Guide:

To authenticate the **local** account via **ssh** only.

Example:

To authenticate the **local** account via **ssh**.

```
Switch# configure terminal
Switch (config)# aaa authentication login ssh local
```

4.2.8 aaa authentication login ssh radius

Command:

```
aaa authentication login ssh radius
```

Default:

ssh : local

Usage Guide:

To authenticate the **radius** account via **ssh** only.

Example:

To authenticate the **local** and **radius** account via **ssh**.

```
Switch# configure terminal
Switch (config)# aaa authentication login ssh local radius
```

4.2.9 aaa authentication login ssh tacacs

Command:

```
aaa authentication login ssh tacacs
```

Default:

ssh : local

Usage Guide:

To authenticate the **tacacs** account via **ssh** only.

Example:

To authenticate the **local** and **radius** and **tacacs** account via **console**.

```
Switch# configure terminal
Switch (config)# aaa authentication login ssh local radius tacacs
```

4.2.10 aaa authentication login telnet local

Command:

```
aaa authentication login telnet local
```

Default:

telnet : local

Usage Guide:

To authenticate the **local** account via **telnet** only.

Example:

To authenticate the **local** account via **telnet**.

```
Switch# configure terminal  
Switch (config)# aaa authentication login telnet local
```

4.2.11 aaa authentication login telnet radius

Command:

```
aaa authentication login telnet radius
```

Default:

telnet : local

Usage Guide:

To authenticate the **radius** account via **telnet** only.

Example:

To authenticate the **local** and **radius** account via **telnet**.

```
Switch# configure terminal  
Switch (config)# aaa authentication login telnet local radius
```

4.2.12 aaa authentication login telnet tacacs

Command:

```
aaa authentication login telnet tacacs
```

Default:

telnet : local

Usage Guide:

To authenticate the **tacacs** account via **telnet** only.

Example:

To authenticate the **local** and **radius** and **tacacs** account via **telnet**.

```
Switch# configure terminal
Switch (config)# aaa authentication login telnet local radius tacacs
```

4.2.13 access management

Command:

```
access management <AccessId : 1-16> <AccessVid : 1-4095> <AddrRangeStart :
ipv4_addr | ipv6_addr> all | snmp | telnet | to | Web
```

<AccessId : 1-16> ID of access management entry

<AccessVid : 1-4095> The VLAN ID for the access management entry

<AddrRangeStart : ipv4_addr> Start IPv4 address

<AddrRangeStart : ipv6_addr> Start IPv6 address

all All services

snmp SNMP service

telnet TELNET/SSH service

to End address of the range

web Web service

Default:

access management : disable

Usage Guide:

To enable the **access management** profile to allow SNMP / Telnet / HTTP services.

Example:

To create a Profile 1 enabling all services for VLAN 1 (IPv6 address 2001::7788) .

```
Switch# configure terminal
Switch (config)# access management 1 1 2001::7788 all
```

4.2.14 access-list ace

Command:

```
access-list ace <Aceld : 1-512> action {deny, permit} | dmac-type {any, broadcast,
multicast, unicast} | frametype {any, arp, etype, ipv4, ipv4-icmp, ipv4-tcp, ipv4-udp,
ipv6, ipv6-icmp, ipv6-tcp, ipv6-udp} | ingress {any, interface 10GigabitEthernet |
GigabitEthernet <PORT_ID>} | logging {disable, next, policy, rate-limiter, shutdown,
tag-priority, vid} | next {<Aceld : 1-512>, last}| policy <PolicyId : 0-255> | rate-limiter
{<RateLimiterId : 1-16>, disable} | redirect {disable, interface 10GigabitEthernet |
GigabitEthernet <PORT_ID>} | tag-priority {0-1, 0-3, 2-3, 4-5, 4-7, 6-7, <TagPriority :
0-7>, any} | vid {<Vid : 1-4095>, any}
```

- <Aceld : 1-512>** ACE ID
- action** Access list action
- dmac-type** The type of destination MAC address
- frametype** Frame type
- ingress** Ingress
- logging** Logging frame information. Note: The logging feature only works when the packet length is less than 1518 (without VLAN tags) and the System Log memory size and logging rate are limited.
- next** Insert the current ACE before the next ACE ID
- policy** Policy
- rate-limiter** Rate limiter
- redirect** Redirect frame to specific port
- shutdown** Shutdown incoming port. The shutdown feature only works when the packet length is less than 1518 (without VLAN tags).
- tag-priority** Tag priority
- vid** VID field

Default:

N/A

Usage Guide:

To create and set up a profile for the **access list**.

Example:

To set a Profile 1 up (**action: permit, dmac-type: unicast, frametype: ipv4-icmp, ingress: any, logging: disable, policy: 1, rate-limiter: 1, tag-priority: 1. vid: 1**).

```
Switch# configure terminal
Switch (config)# access-list ace 1 action permit dmac-type unicast frametype
ipv4-icmp ingress any logging disable policy 1 rate-limiter 1 tag-priority 1 vid 1
```

4.2.15 access-list ace update

Command:

```
access-list ace update <Aceld : 1-512> action {deny, permit} | dmac-type {any,
broadcast, multicast, unicast} | frametype {any, arp, etype, ipv4, ipv4-icmp, ipv4-tcp,
ipv4-udp, ipv6, ipv6-icmp, ipv6-tcp, ipv6-udp} | ingress {any, interface
10GigabitEthernet | GigabitEthernet <PORT_ID>} | logging {disable, next, policy,
rate-limiter, shutdown, tag-priority, vid} | next {<Aceld : 1-512>, last}| policy
<PolicyId : 0-255> | rate-limiter {<RateLimiterId : 1-16>, disable} | redirect {disable,
interface 10GigabitEthernet | GigabitEthernet <PORT_ID>} | tag-priority {0-1, 0-3, 2-3,
4-5, 4-7, 6-7, <TagPriority : 0-7>, any} | vid {<Vid : 1-4095>, any}
```

<Aceld : 1-512>	ACE ID
action	Access list action
dmac-type	The type of destination MAC address
frametype	Frame type
ingress	Ingress
logging	Logging frame information. Note: The logging feature only works when the packet length is less than 1518 (without VLAN tags) and the System Log memory size and logging rate are limited.
next	Insert the current ACE before the next ACE ID
policy	Policy
rate-limiter	Rate limiter
redirect	Redirect frame to specific port
shutdown	Shutdown incoming port. The shutdown feature only works when the packet length is less than 1518 (without VLAN tags).

tag-priority Tag priority
vid VID field

Default:

N/A

Usage Guide:

To update the specific profile for the **access list**.

Example:

Original:

Profile 1 (action: permit, dmac-type: unicast, frametype: ipv4-icmp, ingress: any, logging: disable, policy: 1, rate-limiter: 1, tag-priority: 1. vid: 1).

Updated:

Profile 1 (action: deny, dmac-type: any, frametype: ipv4-icmp, ingress: any, logging: disable, policy: 1, rate-limiter: 1, tag-priority: 1. vid: 1).

```
Switch# configure terminal
Switch (config)# access-list ace update 1 action deny dmac-type any
```

4.2.16 access-list rate-limiter

Command:

```
access-list rate-limiter <RateLimiterList : 1~16> pps <PpsRate : 0-131071>
```

<RateLimiterList : 1~16> Rate limiter ID

<PpsRate : 0-131071> Rate value

Default:

0

Usage Guide:

To set pps rate for specific **rate-limiter ID**.

Example:

To set pps rate(10000 pps) for specific **rate-limiter ID 1**.

```
Switch# configure terminal
Switch (config)# access-list rate-limiter 1 pps 10000
```

4.2.17 access-list rate-limiter pps

Command:

```
access-list rate-limiter pps <PpsRate : 0-131071>
```

<PpsRate : 0-131071> Rate value

Default:

0

Usage Guide:

To set pps rate for all **rate-limiter ID**.

Example:

To set pps rate(10000 pps) for all **rate-limiter ID**.

```
Switch# configure terminal
Switch (config)# access-list rate-limiter pps 100
```

4.2.18 aggregation mode

Command:

```
aggregation mode dmac | ip | port | smac
```

dmac Destination MAC affects the distribution

ip IP address affects the distribution

port IP port affects the distribution

smac Source MAC affects the distribution

Default:

SMAC : Enabled

DMAC : Disabled

IP : Enabled

Port : Enabled

Usage Guide:

To configure **static aggregation mode type**.

Example:

To configure **static aggregation mode type** with **Destination MAC affects the distribution** and **Source MAC affects the**

distribution only.

```
Switch# configure terminal
Switch (config)# access-list rate-limiter pps 100
```

4.2.19 aggregation mode

Command:

```
aggregation mode dmac | ip | port | smac
```

dmac Destination MAC affects the distribution
ip IP address affects the distribution
port IP port affects the distribution
smac Source MAC affects the distribution

Default:

SMAC : Enabled
 DMAC : Disabled
 IP : Enabled
 Port : Enabled

Usage Guide:

To configure **static aggregation mode type**.

Example:

To configure **static aggregation mode type** with **Destination MAC affects the distribution** and **Source MAC affects the distribution** only.

```
Switch# configure terminal
Switch (config)# access-list rate-limiter pps 100
```

4.2.20 banner

Command:

```
banner <LINE>
```

<LINE> c banner-text c, where 'c' is a delimiting character

Default:

N/A

Usage Guide:

To configure **banner-text**.

Example:

To configure **banner-text** with word "dddd".

```
Switch# configure terminal
Switch (config)# banner 1
Enter TEXT message. End with the character '1'.
dddd
1
```

Telnet 192.168.0.100

```
dddd

Username:
```

4.2.21 banner exec

Command:

```
banner login <LINE>
```

<LINE> c banner-text c, where 'c' is a delimiting character

Default:

N/A

Usage Guide:

To configure **login banner-text**.

Example:

To configure **login banner-text** with word "wwwwwwwww".

```
Switch# configure terminal
Switch (config)# banner exec 1
Enter TEXT message. End with the character '1'.
ggggggg
1
```

Telnet 192.168.0.100:

```
Username: admin
Password:

gggggg

#
```

4.2.22 banner login

Command:

```
banner login <LINE>
```

<LINE> c banner-text c, where 'c' is a delimiting character

Default:

N/A

Usage Guide:

To configure **login banner-text**.

Example:

To configure **login banner-text** with word "wwwwwwwwww".

```
Switch# configure terminal
Switch (config)# banner login 1
Enter TEXT message. End with the character '1'.
wwwwwwwwww
1
```

Console:

```
Press ENTER to get started

wwwwwwwwww

Username: admin
Password:
```

4.2.23 banner motd

Command:

```
banner motd <LINE>
```

<LINE> c banner-text c, where 'c' is a delimiting character

Default:

N/A

Usage Guide:

To configure **motd banner-text**.

Example:

To configure **motd banner-text** with word "fffff".

```
Switch# configure terminal
Switch (config)# banner motd 1
Enter TEXT message. End with the character '1'.
fffff
1
```

Console:

```
fffff

Press ENTER to get started

Username:
```

4.2.24 clock summer-time

Command:

```
clock summer-time <WORD> date <Monthstart: 1-12> <Daystart: 1-31> <Yearstart:
1-12> <Timestart: hh:mm > <Monthend: 1-12> <Dayend: 1-31> <Yearend: 1-12>
<Timeend: hh:mm > <Offset minutes: 1-1440 >
```

Default:

N/A

Usage Guide:

To set daylight saving.

Example:

To set daylight saving (Started time: Feb, 3. 2013 8:8AM, End time: Dec, 31. 2013 8:8AM, Offset time: 60 minutes).

```
Switch# configure terminal
Switch (config)# clock summer-time 1 date 2 3 2013 8:8 12 31 2013 8:8 60
```

4.2.25 clock timezone

Command:

```
clock timezone <WORD> <timezone: -23-23>
```

<WORD> name of time zone

Default:

0

Usage Guide:

To set timezone.

Example:

To set timezone (GMT -15) with **profile 1**.

```
Switch# configure terminal
Switch (config)# clock timezone 1 -15
```

4.2.26 default access-list rate-limiter

Command:

```
default access-list rate-limiter <RateLimiterId : 1-16>
```

<RateLimiterId : 1-16> Rate limiter ID

Default:

0

Usage Guide:

To default the **Rate limiter**.

Example:

To default the **Rate limiter ID 1**.

```
Switch# configure terminal
Switch (config)# default access-list rate-limiter 1
```

4.2.27 dot1x authentication timer inactivity

Command:

```
dot1x authentication timer inactivity <10-1000000>
```

Default:

Aging period: 300

Usage Guide:

To set the **Aging period** for **Network Access Server**.

Example:

To set the **Aging period (147 seconds)**.

```
Switch# configure terminal
Switch (config)# dot1x authentication timer inactivity 147
```

4.2.28 dot1x authentication timer re-authenticate

Command:

```
dot1x authentication timer re-authenticate <1-3600>
```

Default:

Re-authenticated Period: 3600

Usage Guide:

To set the **Re-authenticated Period** for **Network Access Server**.

Example:

To set the **Re-authenticated Period (777 seconds)**.

```
Switch# configure terminal
Switch (config)# dot1x authentication timer re-authenticate 777
```

4.2.29 dot1x feature

Command:

```
dot1x feature guest-vlan | radius-qos | radius-vlan
```

Default:

Disable

Usage Guide:

To enable the **guest-vlan**, **radius-qos**, **radius-vlan** for **Network Access Server**

Example:

To enable the **guest-vlan**, **radius-qos**, **radius-vlan** for **Network Access Server**.

```
Switch# configure terminal
Switch (config)# dot1x authentication timer re-authenticate 777
```

4.2.30 dot1x guest-vlan

Command:

```
dot1x guest-vlan <1-4095>
```

<1-4095> Guest VLAN ID used when entering the Guest VLAN.

Default:

1

Usage Guide:

To set the value of **guest-vlan** for **Network Access Server**

Example:

To set the value of **guest-vlan(2)** for **Network Access Server**

```
Switch# configure terminal
Switch (config)# dot1x guest-vlan 2
```

4.2.31 dot1x guest-vlan supplicant

Command:

dot1x guest-vlan supplicant

supplicant The switch remembers if an EAPOL frame has been received on the port for the life-time of the port. Once the switch considers whether to enter the Guest VLAN, it will first check if this option is enabled or disabled.

Default:

Disable

Usage Guide:

To allow all frames automatically entering **guest-vlan** for **Network Access Server**

Example:

To allow all frames automatically entering **guest-vlan** for **Network Access Server**

```
Switch# configure terminal
Switch (config)# dot1x guest-vlan supplicant
```

4.2.32 dot1x max-reauth-req

Command:

```
dot1x max-reauth-req <1-255>
```

Default:

2

Usage Guide:

To define 802.1X re-authentication frequency for **Network Access Server**

Example:

To define 802.1X re-authentication frequency with 78 times for **Network Access Server**

```
Switch# configure terminal
Switch (config)# dot1x max-reauth-req 78
```

4.2.33 dot1x system-auth-control

Command:

```
dot1x system-auth-control
```

Default:

Disable

Usage Guide:To enable 802.1X service for **Network Access Server****Example:**To enable 802.1X service for **Network Access Server**

```
Switch# configure terminal
Switch (config)# dot1x system-auth-control
```

4.2.34 dot1x timeout quiet-period

Command:

```
dot1x timeout quiet-period <10-1000000>
```

quiet-period Time in seconds before a MAC-address that failed authentication gets a new authentication chance.

Default:

10

Usage Guide:To configure 802.1X **hold time** for **Network Access Server****Example:**To configure 802.1X **hold time**(12 seconds) for **Network Access Server**

```
Switch# configure terminal
Switch (config)# dot1x timeout quiet-period 12
```

4.2.35 dot1x timeout tx-period

Command:

```
dot1x timeout tx-period <1-65535>
```

tx-period The time between EAPOL retransmissions.

Default:

30

Usage Guide:To configure 802.1X **EPOAL timeout** for **Network Access Server****Example:**

To configure 802.1X **EPOAL timeout** (45 seconds) for **Network Access Server**

```
Switch# configure terminal
Switch (config)# dot1x timeout tx-period 45
```

4.2.36 enable password

Command:

```
enable password <WORD>
```

<WORD> The UNENCRYPTED (cleartext) password.

Default:

Disable

Usage Guide:

To configure **enable password** for user

Example:

To configure **enable password**(admin) for user

```
Switch# configure terminal
Switch (config)# enable password admin

Press ENTER to get started

Username:
Password:

> enable
Password: *****

#
```

4.2.37 enable password level

Command:

```
enable password level <1-15> <WORD>
```

<1-15> Level number

<WORD> The UNENCRYPTED (cleartext) password.

Default:

Disable

Usage Guide:

To configure **enable password** and specific level for user

Example:

To configure **enable password**(admin) and specific level(15) for user

```
Switch# configure terminal
Switch (config)# enable password level 15 admin

Press ENTER to get started

Username:
Password:

> enable
Password: admin
#
```

4.2.38 enable secret

Command:

```
enable secret 0 | 5 level <1-15> <WORD>
```

- 0** Specifies an UNENCRYPTED password will follow
- 5** Specifies an ENCRYPTED secret will follow
- <1-15>** Level number
- <WORD>** The UNENCRYPTED (cleartext) / ENCRYPTED(MD5) password.

Default:

Disable

Usage Guide:

To configure **enable password** to encrypted secret in the system configurations and specific level for user

Example:

To configure **enable password**(cisco) to encrypted secret in the system configurations and specific level(15) for user

```
Switch# configure terminal
Switch (config)# enable secret 0 level 15 cisco

# show running-config
Building configuration...
```

```
enable secret 5 level 15 FC89368B9513DE0760290BCE9A1DA90A
```

```
.....
```

```
Press ENTER to get started
```

```
Username:
```

```
Password:
```

```
> enable
```

```
Password: cisco
```

```
#
```

4.2.39 end

Command:

```
end
```

Default:

N/A

Usage Guide:

To level the **configure terminal** mode

Example:

To level the **configure terminal** mode

```
Switch# configure terminal
```

```
Switch (config)# end
```

```
#
```

4.2.40 erps <1-64> guard

Command:

```
erps <1-64> guard <10-2000>
```

<1-64> ERPS group number

<10-2000> Guard time in ms

Default:

500

Usage Guide:

To configure the **Guard Time** for **ERPS**.

Example:

To configure the **Guard Time**(178 ms) for **ERPS**(Profile 1)

```
Switch# configure terminal
Switch (config)# erps 1 guard 178
```

4.2.41 erps <1-64> holdoff

Command:

```
erps <1-64> holdoff < 0-10000>
```

<1-64> ERPS group number

< 0-10000> Holdoff time in ms

Default:

0

Usage Guide:

To configure the **Hold Off Time** for **ERPS**

Example:

To configure the **Hold Off Time** (900 ms) for **ERPS**(Profile 1)

```
Switch# configure terminal
Switch (config)# erps 1 holdoff 900
```

4.2.42 erps <1-64> major

Command:

```
erps <1-64> major port0 interface {10GigabitEthernet, GigabitEthernet} <PORT0_ID>
port1 interface {10GigabitEthernet, GigabitEthernet} <PORT1_ID> [ interconnect ]
```

<1-64> ERPS group number

interconnect Major ring is interconnected

Default:

0

Usage Guide:

To create a profile and configure the **Major ERPS interface port 0, port 1.**

Example:

To create a profile 1 and configure the **Major ERPS interface port 0(GigabitEthernet 1/1), port 1(GigabitEthernet 1/2)** without **interconnected mode**

```
Switch# configure terminal
Switch (config)# erps 1 major port0 interface GigabitEthernet 1/1 port1 interface
GigabitEthernet 1/2
```

4.2.43 erps <1-64> mep

Command:

```
erps <1-64> mep port0 sf <p0_sf: 1-100> aps <p0_aps: 1-100> port1 sf <p1_sf: 1-100>
aps <p1_aps: 1-100>
```

<1-64> ERPS group number

<p0_sf: 1-100> Index of Port 0 SignalFail MEP

<p0_aps: 1-100> Index of Port 0 APS MEP

<p1_sf: 1-100> Index of Port 1 SignalFail MEP

<p1_aps: 1-100> Index of Port 1 APS MEP

Default:

0

Usage Guide:

To configure **ERPS Instance Data** for specific **ERPS** profile.

Example:

To configure **ERPS Instance Data(Port0: SF MEP = 2, APS MEP = 1. Port1: SF MEP = 4, APS MEP = 3)** for specific **ERPS** profile(1).

```
Switch# configure terminal
```

```
Switch (config)# erps 1 mep port0 sf 2 aps 1 port1 sf 4 aps 3
```

4.2.44 erps <1-64> mep

Command:

```
erps <1-64> revertive <wtr_time_minutes: 1-12>
```

<1-64> ERPS group number

<wtr_time_minutes: 1-12> Wait-to-restore time in minutes

Default:

0

Usage Guide:

To configure **WTR time** for specific **ERPS** profile.

Example:

To configure **WTR time**(5 minutes) for specific **ERPS** profile 1.

```
Switch# configure terminal
Switch (config)# erps 1 revertive 5
```

4.2.45 erps <1-64> rpl neighbor

Command:

```
erps <1-64> rpl neighbor { port0 | port1 }
```

port0 ERPS Port 0 interface

port1 ERPS Port 1 interface

Default:

N/A

Usage Guide:

To configure **Ring Protection Link Neighbor Role** for specific **ERPS** interface.

Example:

To configure **Ring Protection Link Neighbor Role** for specific **ERPS** interface..

```
Switch# configure terminal
Switch (config)# erps 1 rpl neighbor port0
```

4.2.46 erps <1-64> rpl owner

Command:

```
erps <1-64> rpl owner { port0 | port1 }
```

port0 ERPS Port 0 interface

port1 ERPS Port 1 interface

Default:

N/A

Usage Guide:

To configure **Ring Protection Link Owner Role** for specific **ERPS** interface.

Example:

To configure **Ring Protection Link Owner Role** for specific **ERPS** interface..

```
Switch# configure terminal
Switch (config)# erps 1 rpl owner port0
```

4.2.47 erps <1-64> sub

Command:

```
erps <1-64> sub port0 interface {10GigabitEthernet, GigabitEthernet} <PORT0_ID>
{ { port0 interface {10GigabitEthernet, GigabitEthernet} <PORT1_ID> }, {interconnect
<major_ring_id: 1-64> [ virtual-channel ] } }
```

<1-64> ERPS group number

interconnect Sub ring is interconnected

<major_ring_id: 1-64> Major ring group number

virtual-channel Enable virtual channel for sub-ring

Default:

0

Usage Guide:

To create a profile and configure the **Sub ERPS interface port 0, port 1**.

Example 1:

To create a profile 3 and configure the **Sub ERPS interface port 0(GigabitEthernet 1/5), port 1(GigabitEthernet 1/6)** without **interconnected mode** and **Major Ring group** and **virtual-channel**

```
Switch# configure terminal
Switch (config)# erps 3 sub port0 interface GigabitEthernet 1/5 port1 interface
GigabitEthernet 1/6
```

Example 2:

To create a profile 2 and configure the **Sub ERPS interface port 0(GigabitEthernet 1/3), port 1(GigabitEthernet 1/4)** with **interconnected mode** and **Major Ring group 1** and **virtual-channel**

```
Switch# configure terminal
Switch (config)# erps 1 sub port0 interface GigabitEthernet 1/3 interconnect 1
virtual-channel
```

4.2.48 erps <1-64> topology-change propagate

Command:

```
erps <1-64> topology-change propagate
```

<1-64> ERPS group number
topology-change Topology Change
propagate Propagate

Default:

N/A

Usage Guide:

To configure **topology change notification (TCN)** propagation for the specific profile.

Example:

To configure **topology change notification (TCN)** propagation for the specific profile 1

```
Switch# configure terminal
Switch (config)# erps 1 topology-change propagate
```

4.2.49 erps <1-64> topology-change propagate

Command:

```
erps <1-64> version 1 | 2
```

<1-64> ERPS group number
version Version

Default:

V2

Usage Guide:

To configure **ERPS version** number for the specific profile.

Example:

To configure **ERPS version 1** for the specific profile 1.

```
Switch# configure terminal
Switch (config)# erps 1 version 1
```

4.2.50 erps <1-64> vlan

Command:

```
erps <1-64> vlan { none | [ add | remove ] <vlans> }
```

<1-64> ERPS group number
<vlan_list> List of VLANs
add Add to set of included VLANs
none Do not include any VLANs
remove Remove from set of included VLANs

Default:

V2

Usage Guide:

To configure **ERPS VLANs** for the specific profile.

Example:

To configure **ERPS VLANs**(VLAN5 - VLAN8) for the specific profile 1.

```
Switch# configure terminal
Switch (config)# erps 1 vlan add 5-8
```

4.2.51 evc

Command:

```
evc <Evclid : 1-4096> vid <evc_vid> ivid <ivid> interface ( * | 10GigabitEthernet |
GigabitEthernet [ <port_list> ] ) learning [ disable ] policer { <PolicerId : 1-2048> |
none | discard }
```

<EvcId : 1-4096> EVC identifier
vid Setup EVC VLAN ID
<EvcVid : 1-4095> EVC VLAN ID
ivid Setup internal EVC VLAN ID
<lvid : vlan_id> Internal VLAN ID
interface Setup NNI
learning Setup learning
policer Policer (ingress bandwidth profile)
<PolicerId : 1-2048> Policer ID
<vlan_list> List of VLANs
discard Map to policer discarding all frames
none Map to policer allowing all frames

Default:

0

Usage Guide:

To configure **Ethernet Virtual Circuits (EVC)**.

Example:

To configure **Ethernet Virtual Circuits (EVC identifier: 1, EVC VLAN ID: 2, GigabitEthernet Port: 1/1, 1/2, Internal VLAN ID: 3, Disable learning, Policer ID: 4)**.

```

Switch# configure terminal
Switch (config)# evc 1 vid 2 interface GigabitEthernet 1/1-2 ivid 3 learning disable
policer 4
    
```

4.2.52 evc ece

Command:

```

evc ece <Ecelid : 1-4096> direction {both | nni-to-uni | uni-to-nyi} evc {<EvcId :
1-4096> | none} frame-type {any | ipv4 | ipv6} inner-tag { add {dei <AddDei : 0-1> |
pcp <AddPcp : 0-7> | preserve | type [c-tag | none | s-custom-tag | s-tag] | vid
<AddVid : vlan_id>}, match {dei [<MatchDei : 0-1> | any]}| pcp [<MatchPcp : pcp> |
any] | type [any | c-tagged | s-tagged | tagged | untagged] | vid [<Vid : 0-4095> |
any]} } interface [* | 10GigabitEthernet | GigabitEthernet] <PORT_ID> next [<Ecelid :
1-4096> | last] outer-tag { add {dei <AddDei : 0-1> | pcp <AddPcp : 0-7> | preserve |
type [c-tag | none | s-custom-tag | s-tag] | vid <AddVid : vlan_id>}, match {dei
[<MatchDei : 0-1> | any]}| pcp [<MatchPcp : pcp> | any] | mode [disable | enable] | vid
[<Vid : 0-4095> | any] } policer {<PolicerId : 1-2048> | discard | evc | none} policy
<PolicyNo : 0-255> pop <Pop : 0-2>
    
```

<EceId : 1-4096> ECE identifier

direction Setup ECE direction

- both** Bidirectional traffic flow
- nni-to-uni** NNI-to-UNI traffic flow
- uni-to-nni** UNI-to-NNI traffic flow

evc EVC mapping

- <EvclId : 1-4096>** EVC identifier
- none** Map to no EVC ID

frame-type Setup matched frame type

- any** Match any frame type
- ipv4** Match IPv4 frames
- ipv6** Match IPv6 frames

inner-tag Setup inner tag options

- add** Setup inner tag add properties.
- dei** Setup added tag DEI
- <AddDei : 0-1>** Added tag DEI
- pcp** Setup added tag PCP
- <AddPcp : 0-7>** Added tag PCP
- preserve** Setup tag PCP/DEI preservation
- type** Setup added tag type
- c-tag** Add C-tag
- none** No tag added
- s-custom-tag** Add custom S-tag
- s-tag** Add S-tag
- vid** Setup added tag VLAN ID
- <AddVid : vlan_id>** Added tag VLAN ID

match Setup inner tag match properties

- dei** Setup matched DEI
- <MatchDei : 0-1>** Matched DEI
- any** Match any DEI
- pcp** Setup matched PCP
- <MatchPcp : pcp>** Matched PCP value/range
- any** Match any PCP
- type** Setup matched tag type
- any** Match tagged and untagged frames
- c-tagged** Match C-tagged frames

s-tagged Match S-tagged frames
tagged Match tagged frames
untagged Match untagged frames
vid Setup matched VLAN ID
<Vid : 0-4095> Matched VLAN ID value/range
any Match any VLAN ID

interface Setup UNI
next Setup the ECE ID of the next entry
<EceId : 1-4096> Select ECE ID of an existing entry
last Make the ECE the last entry

outer-tag Setup outer tag options
add Setup outer tag add properties
dei Setup added tag DEI
<AddDei : 0-1> Added tag DEI
mode Setup NNI-to-UNI outer tag add mode
disable No tag added when forwarding to UNI
enable Add tag when forwarding to UNI
pcp Setup added tag PCP
<AddPcp : 0-7> Added tag PCP
preserve Setup tag PCP/DEI preservation
vid Setup added tag VLAN ID
<AddVid : vlan_id> Added tag VLAN ID
match Setup outer tag match properties
policer Policer (ingress bandwidth profile)
<PolicerId : 1-2048> Policer ID
discard Map to policer discarding all frames
evc Use policer setup for EVC
none Map to policer allowing all frames

policy Setup ACL policy
<PolicyNo : 0-255> ACL policy

pop Setup tag popping
<Pop : 0-2> Number of tags popped

Default:

N/A

Usage Guide:

To configure **EVC Control Entry**.

Example:

To configure EVC Control Entry as tabled below.

UNI Ports																				
1	2	3	4	5	6	7	8	9	10	11	12	13	14	15	16	17	18	19	20	21
<input type="checkbox"/>	<input type="checkbox"/>	<input checked="" type="checkbox"/>	<input type="checkbox"/>	<input type="checkbox"/>	<input type="checkbox"/>	<input type="checkbox"/>	<input type="checkbox"/>	<input type="checkbox"/>	<input type="checkbox"/>	<input type="checkbox"/>	<input type="checkbox"/>	<input type="checkbox"/>	<input type="checkbox"/>	<input type="checkbox"/>	<input type="checkbox"/>	<input type="checkbox"/>	<input type="checkbox"/>	<input type="checkbox"/>	<input type="checkbox"/>	<input type="checkbox"/>

Ingress Matching		Actions	
Tag Type	C-Tagged	Direction	Both
VLAN ID Filter	Specific	EVC ID Filter	Specific
VLAN ID Value	6	EVC ID Value	2
PCP	Any	Policer ID Filter	Specific
DEI	Any	Policer ID Value	8
Inner Tag Type	Any	Tag Pop Count	2
Frame Type	IPv4	Policy ID	9
DSCP Filter	Any		

Egress Outer Tag		Egress Inner Tag	
Mode	Enabled	Type	S-custom-tag
VLAN ID	7	VLAN ID	5
PCP/DEI Preservation	Fixed	PCP/DEI Preservation	Preserved
PCP	2	PCP	4
DEI	0	DEI	1

```
Switch# configure terminal
Switch (config)# evc ece 1 direction both evc 2 frame-type ipv4 inner-tag add dei 1
pcp 4 preserve type s-custom-tag vid 5 interface GigabitEthernet 1/3 outer-tag add
dei 0 mode enable pcp 2 vid 7 match dei any pcp any type c-tagged vid 6 policer 8
policy 9 pop 2
```

4.2.53 evc ece update

Command:

```
evc ece update <EceId : 1-4096> direction {both | nni-to-uni | uni-to-nyi} evc
{<EvcId : 1-4096> | none} frame-type {any | ipv4 | ipv6} inner-tag { add {dei <AddDei :
0-1> | pcp <AddPcp : 0-7> | preserve | type [c-tag | none | s-custom-tag | s-tag] | vid
<AddVid : vlan_id>}, match {dei [<MatchDei : 0-1> | any]} pcp [<MatchPcp : pcp> |
any] | type [any | c-tagged | s-tagged | tagged | untagged] | vid [<Vid : 0-4095> |
any]} } interface [* | 10GigabitEthernet | GigabitEthernet] <PORT_ID> next [<EceId :
1-4096> | last] outer-tag { add {dei <AddDei : 0-1> | pcp <AddPcp : 0-7> | preserve |
type [c-tag | none | s-custom-tag | s-tag] | vid <AddVid : vlan_id>}, match {dei
[<MatchDei : 0-1> | any]} pcp [<MatchPcp : pcp> | any] | mode [disable | enable] | vid
```

[<Vid : 0-4095> | any] } policer {<PolicerId : 1-2048> | discard | evc | none} policy
 <PolicyNo : 0-255> pop <Pop : 0-2>

<EcelId : 1-4096> ECE identifier

direction Setup ECE direction

- both** Bidirectional traffic flow
- nni-to-uni** NNI-to-UNI traffic flow
- uni-to-nni** UNI-to-NNI traffic flow

evc EVC mapping

- <EvcId : 1-4096> EVC identifier
- none** Map to no EVC ID

frame-type Setup matched frame type

- any** Match any frame type
- ipv4** Match IPv4 frames
- ipv6** Match IPv6 frames

inner-tag Setup inner tag options

- add** Setup inner tag add properties.
- dei** Setup added tag DEI
- <AddDei : 0-1> Added tag DEI
- pcp** Setup added tag PCP
- <AddPcp : 0-7> Added tag PCP
- preserve** Setup tag PCP/DEI preservation
- type** Setup added tag type
- c-tag** Add C-tag
- none** No tag added
- s-custom-tag** Add custom S-tag
- s-tag** Add S-tag
- vid** Setup added tag VLAN ID
- <AddVid : vlan_id> Added tag VLAN ID

match Setup inner tag match properties

- dei** Setup matched DEI
- <MatchDei : 0-1> Matched DEI
- any** Match any DEI
- pcp** Setup matched PCP
- <MatchPcp : pcp> Matched PCP value/range
- any** Match any PCP
- type** Setup matched tag type

any Match tagged and untagged frames
c-tagged Match C-tagged frames
s-tagged Match S-tagged frames
tagged Match tagged frames
untagged Match untagged frames
vid Setup matched VLAN ID
<Vid : 0-4095> Matched VLAN ID value/range
any Match any VLAN ID

interface Setup UNI

next Setup the ECE ID of the next entry
<EceId : 1-4096> Select ECE ID of an existing entry
last Make the ECE the last entry

outer-tag Setup outer tag options
add Setup outer tag add properties
dei Setup added tag DEI
<AddDei : 0-1> Added tag DEI
mode Setup NNI-to-UNI outer tag add mode
disable No tag added when forwarding to UNI
enable Add tag when forwarding to UNI
pcp Setup added tag PCP
<AddPcp : 0-7> Added tag PCP
preserve Setup tag PCP/DEI preservation
vid Setup added tag VLAN ID
<AddVid : vlan_id> Added tag VLAN ID
match Setup outer tag match properties
policer Policer (ingress bandwidth profile)
<PolicerId : 1-2048> Policer ID
discard Map to policer discarding all frames
evc Use policer setup for EVC
none Map to policer allowing all frames

policy Setup ACL policy
<PolicyNo : 0-255> ACL policy

pop Setup tag popping
<Pop : 0-2> Number of tags popped

Default:

N/A

Usage Guide:

To update **EVC Control Entry** for specific **ECE** profile.

Example 1:

To update “**direction nni-to-uni**” for **ECE** profile 1.

```
Switch# configure terminal
Switch (config)# evc ece 1 direction nni-to-uni
```

4.2.54 evc policer

Command:

```
evc policer <PolicerId : 1-2048> [enable | disable] cbs <Cbs : 0-100000> cir <Cir : 0-10000000> ebs <Ebs : 0-100000> eir <Eir : 0-10000000> mode [aware | blind | coupled] rate-type [data | line] type [mef | single]
```

<PolicerId : 1-2048> Policer ID

cbs Setup CBS

<Cbs : 0-100000> Committed Burst Size [bytes]

cir Setup CIR

<Cir : 0-10000000> Committed Information Rate [kbps]

disable Disable policer

ebs Setup EBS for MEF policer

<Ebs : 0-100000> Excess Burst Size [bytes]

eir Setup EIR for MEF policer

<Eir : 0-10000000> Excess Information Rate [kbps]

enable Enable policer

mode Setup policer mode

aware Color-aware mode

blind Color-blind mode

coupled Coupling mode

rate-type Setup rate type

data Data rate policing

line Line rate policing

type Setup policer type

mef MEF ingress bandwidth profile

single Single bucket policer

Default:

N/A

Usage Guide:

To configure a profile for **EVC Policer (Ingress Bandwidth Profile)** .

Example:

To configure **EVC Policer (Ingress Bandwidth Profile)** as tabled below.

Policer ID	State	Type	Policer Mode	Rate Type	CIR (kbps)	CBS (bytes)	EIR (kbps)	EBS (bytes)
1	Enabled	MEF	Aware	Data	30	20	50	40

```
Switch# configure terminal
Switch (config)# evc policer 1 enable cbs 20 cir 30 ebs 40 eir 50 mode aware rate-type
data type mef
```

4.2.55 evc policer update

Command:

```
evc policer update <PolicerId : 1-2048> [enable | disable] cbs <Cbs : 0-100000> cir
<Cir : 0-10000000> ebs <Ebs : 0-100000> eir <Eir : 0-10000000> mode [aware | blind |
coupled] rate-type [data | line] type [mef | single]
```

- <PolicerId : 1-2048>** Policer ID
- cbs** Setup CBS
- <Cbs : 0-100000>** Committed Burst Size [bytes]
- cir** Setup CIR
- <Cir : 0-10000000>** Committed Information Rate [kbps]
- disable** Disable policer
- ebs** Setup EBS for MEF policer
- <Ebs : 0-100000>** Excess Burst Size [bytes]
- eir** Setup EIR for MEF policer
- <Eir : 0-10000000>** Excess Information Rate [kbps]
- enable** Enable policer
- mode** Setup policer mode
- aware** Color-aware mode
- blind** Color-blind mode
- coupled** Coupling mode
- rate-type** Setup rate type
- data** Data rate policing
- line** Line rate policing
- type** Setup policer type
- mef** MEF ingress bandwidth profile
- single** Single bucket policer

Default:

N/A

Usage Guide:

To update a profile for **EVC Policer (Ingress Bandwidth Profile)**.

Example:

To update **EVC Policer (Ingress Bandwidth Profile)** with **EIR 1000** for policer 1

```
Switch# configure terminal
Switch (config)# evc policer update 1 eir 1000
```

4.2.56 evc update

Command:

```
evc update <Evclid : 1-4096> vid <evc_vid> ivid <ivid> interface ( * |
10GigabitEthernet | GigabitEthernet [ <port_list> ] ) learning [ disable ] policer
{ <PolicerId : 1-2048> | none | discard }
```

- <Evclid : 1-4096>** EVC identifier
- vid** Setup EVC VLAN ID
- <EvcVid : 1-4095>** EVC VLAN ID
- ivid** Setup internal EVC VLAN ID
- <Ivid : vlan_id>** Internal VLAN ID
- interface** Setup NNI
- learning** Setup learning
- policer** Policer (ingress bandwidth profile)
- <PolicerId : 1-2048>** Policer ID
- <vlan_list>** List of VLANs
- discard** Map to policer discarding all frames
- none** Map to policer allowing all frames

Default:

0

Usage Guide:

To update an ID for **Ethernet Virtual Circuits (EVC)**.

Example:

To update **Ethernet Virtual Circuits (EVC identifier: 1, EVC VLAN ID: 10)**.

```
Switch# configure terminal
Switch (config)# evc update 1 vid 10
```

4.2.57 exit

Command:

```
exit
```

Default:

N/A

Usage Guide:

To exit **configure terminal** mode.

Example:

To exit **configure terminal** mode.

```
Switch# configure terminal
Switch (config)# exit
#
```

4.2.58 green-ethernet led interval

Command:

```
green-ethernet led interval <0~24> intensity <0-100>
```

<0~24> Interval from 00.00 to 24.00 (00 is used to start at midnight, while 24 is used to stop at midnight).

intensity LEDs intensity.

<0-100> Intensity from 0% (LEDs OFF) to 100%

Default:

N/A

Usage Guide:

To configure **LED Power reduction** for interval time.

Example:

To configure **LED Power reduction** as tabled below.

Start Time	End Time	Intensity
08:00 ▾	13:00 ▾	80 ▾ %
13:00 ▾	08:00 ▾	20 ▾ %

```
Switch# configure terminal
Switch (config)# green-ethernet led interval 8-13 intensity 80
```

4.2.59 green-ethernet led on-event

Command:

```
green-ethernet led on-event error | link-change <0-65535>
```

- error** Set LEDs intensity to 100% if an error occurs.
- link-change** Specifies how long to turn LEDs intensity into 100%, when a link changes state.
- <0-65535>** Number of seconds to set LEDs intensity at 100% at link change.

Default:

N/A

Usage Guide:

To configure **LED Power on-event** to trigger LED light

Example:

To configure **LED Power on-event** as tabled below:

On time at link change	On at errors
55 Sec.	<input checked="" type="checkbox"/>

```
Switch# configure terminal
Switch (config)# green-ethernet led on-event error link-change 55
```

4.2.60 gvrp

Command:

```
gvrp
```

Default:

Disable

Usage Guide:

To enable **GVRP**.

Example:

To enable **GVRP**.

```
Switch# configure terminal
Switch (config)# gvrp
```

4.2.61 gvrp max-vlans

Command:

```
gvrp max-vlans <1-4095>
```

Default:

20

Usage Guide:

To configure how many VLANs will be in **GVRP**.

Example:

To configure 200 VLANs in **GVRP**.

```
Switch# configure terminal
Switch (config)# gvrp max-vlans 200
```

4.2.62 gvrp time

Command:

```
gvrp time join-time <Jointime : 1-20> leave-all-time <Leavealltime : 1000-5000>
leave-time <Leavetime : 60-300>
```

join-time Set GARP protocol parameter JoinTime. See IEEE 802.1D-2004, clause 12.11

<Jointime : 1-20> join-time in units of centi seconds. Range is 1-20. Default is 20.

leave-all-time Set GARP protocol parameter LeaveAllTime. See IEEE 802.1D-2004, clause 12.11

<Leavealltime : 1000-5000> leave-all-time in units of centi seconds Range is 1000-5000. Default is 1000.

leave-time Set GARP protocol parameter LeaveTime. See IEEE 802.1D-2004, clause 12.11

<Leavetime : 60-300> leave-time in units of centi seconds. Range is 60-300. Default is 60.

Default:

Join-time:	20
Leave-time:	60
LeaveAll-time:	1000

Usage Guide:

To configure **Join-time**, **Leave-time**, **Leave all-time** for **GVRP**.

Example:

To configure **Join-time**, **Leave-time**, **Leave all-time** for **GVRP** as tabled below.

Join-time:	5
Leave-time:	150
LeaveAll-time:	1200

```
Switch# configure terminal
Switch (config)# gvrp time join-time 5 leave-all-time 1200 leave-time 150
```

4.2.63 help

Command:

```
help
```

Default:

N/A

Usage Guide:

To explain how to use commands.

Example:

To explain how to use commands.

```
Switch# configure terminal
Switch (config)# help

Help may be requested at any point in a command by entering
a question mark '?'. If nothing matches, the help list will
be empty and you must back up until entering a '?' showing the
available options.

Two styles of help are provided:

1. Full help is available when you are ready to enter a
   command argument (e.g. 'show ?') and describes each possible
   argument.

2. Partial help is provided when an abbreviated argument is entered
   and you want to know what arguments match the input
```

(e.g. 'show pr?'.)

4.2.64 hostname

Command:

```
hostname < WORD >
```

< WORD > This system's network name

Default:

N/A

Usage Guide:

To configure switch's **hostname**.

Example:

To configure switch's **hostname** with "planetbestswitch"

```
Switch# configure terminal
Switch (config)# hostname planetbestswitch
planetbestswitch(config)#
```

4.2.65 interface * | 10GigabitEthernet | GigabitEthernet

Command:

```
interface * | 10GigabitEthernet <port_type_list> | GigabitEthernet <port_type_list>
```

*	All switches or All ports
GigabitEthernet	1 Gigabit Ethernet Port
10GigabitEthernet	10 Gigabit Ethernet Port

Default:

N/A

Usage Guide:

To enter the **interface mode**.

Example:

To enter the **interface 10GigabitEthernet 1/2**

```
Switch# configure terminal
```

```
Switch (config)# interface 10GigabitEthernet 1/2
Switch (config-if) #
```

4.2.65.1 access-list action permit

Command:

```
access-list action permit
```

action Access list action

Default:

Permit

Usage Guide:

To configure **Permit** for the **ACL action**.

Example:

To configure **Permit ACL action** for the **GigabitEthernet X/X**.

```
Switch# configure terminal
Switch (config)# interface GigabitEthernet X/X
Switch (config-if) # access-list action permit
```

4.2.65.2 access-list action deny

Command:

```
access-list action deny
```

action Access list action

Default:

Deny

Usage Guide:

To configure **Deny** for the **ACL action**.

Example:

To configure **Deny ACL action** for the **GigabitEthernet X/X**.

```
Switch# configure terminal
Switch (config)# interface GigabitEthernet X/X
Switch (config-if) # access-list action deny
```

4.2.65.3 access-list logging

Command:

```
access-list logging
```

logging Logging frame information. Note: The logging feature only works when the packet length is less than 1518 (without VLAN tags) and the System Log memory size and logging rate is limited.

Default:

Disable

Usage Guide:

To enable **Logging** function for the **ACL**.

Example:

To enable **ACL Logging** function for the **GigabitEthernet X/X**.

```
Switch# configure terminal
Switch (config)# interface GigabitEthernet X/X
Switch (config-if) # access-list logging
```

4.2.65.4 access-list policy

Command:

```
access-list policy <PolicyId : 0-255>
```

policy Policy
<PolicyId : 0-255> Policy ID

Default:

Policy ID: 0

Usage Guide:

To configure **Policy ID** for the **ACL**.

Example:

To configure **ACL Policy ID 1** for the **GigabitEthernet X/X**.

```
Switch# configure terminal
Switch (config)# interface GigabitEthernet X/X
Switch (config-if) # access-list policy 1
```

4.2.65.5 access-list port-state

Command:

```
access-list port-state
```

port-state Re-enable shutdown port that was shutdown by access-list module

Default:

Enable

Usage Guide:

To enable **Port-state** function for the **ACL**.

Example:

To configure **ACL Port-state** function for the **GigabitEthernet X/X**.

```
Switch# configure terminal
Switch (config)# interface GigabitEthernet X/X
Switch (config-if) # access-list port-state
```

4.2.65.6 access-list rate-limiter

Command:

```
access-list rate-limiter <RateLimiterId : 1-16>
```

rate-limiter Rate limiter

<RateLimiterId : 1-16> Rate limiter ID

Default:

Disable

Usage Guide:

To apply **Rate Limiter ID** for the **ACL**.

Example:

To apply **ACL Rate Limiter ID 1** for the **GigabitEthernet X/X**.

```
Switch# configure terminal
Switch (config)# interface GigabitEthernet X/X
Switch (config-if) # access-list rate-limiter 1
```

4.2.65.7 access-list redirect interface

Command:

```
access-list redirect interface 10GigabitEthernet <port_type_list> | GigabitEthernet
<port_type_list>
```

redirect Redirect frame to specific port

Default:

Disable

Usage Guide:

To redirect frames to specific Port.

Example:

To redirect **GigabitEthernet X/X** frames to **GigabitEthernet 1/2**.

```
Switch# configure terminal
Switch (config)# interface GigabitEthernet X/X
Switch (config-if) # access-list redirect interface GigabitEthernet 1/2
```

4.2.65.8 access-list shutdown

Command:

```
access-list shutdown
```

shutdown Shut down incoming port. The shutdown feature only works when the packet length is less than 1518 (without VLAN tags).

Default:

Disable

Usage Guide:

To enable **Shutdown** function for the **ACL**.

Example:

To enable **ACL Shutdown** function for the **GigabitEthernet X/X**.

```
Switch# configure terminal
Switch (config)# interface GigabitEthernet X/X
Switch (config-if) # access-list shutdown
```

4.2.65.9 aggregation group

Command:

```
aggregation group <uint>
```

aggregation Create an aggregation

group Create an aggregation group

<uint> The aggregation group id

Default:

N/A

Usage Guide:

To configure **aggregation group**.

Example:

To configure **aggregation group 7** for the **GigabitEthernet X/X**.

```
Switch# configure terminal
Switch (config)# interface GigabitEthernet X/X
Switch (config-if) # aggregation group 7
```

4.2.65.10 description

Command:

```
description <string>
```

description Port description

<string> specifies a comment or a description of the port to assist the user. (Length: 1-12 characters)

Default:

N/A

Usage Guide:

To configure port description.

Example:

To configure port description (IPTV_Port) for the **GigabitEthernet X/X**.

```
Switch# configure terminal
Switch (config)# interface GigabitEthernet X/X
Switch (config-if) # description IPTV_Port
```

4.2.65.11 do

Command:

```
do < exec commands >
```

do To run exec commands in config mode

Default:

N/A

Usage Guide:

To run **exec commands** in **configure terminal mode**

Example:

To run "show aaa" in **configure terminal mode**.

```
Switch# configure terminal
Switch (config)# interface GigabitEthernet X/X
Switch (config-if) # do show aaa
console : local
telnet  : local
ssh    : local
http   : local
```

4.2.65.12 dot1x guest-vlan

Command:

```
dot1x guest-vlan
```

dot1x IEEE Standard for port-based Network Access Control

guest-vlan Enables/disables guest VLAN

Default:

Disable

Usage Guide:

To enable **Guest VLAN**

Example:

To enable **Guest VLAN** for **GigabitEthernet X/X**.

```
Switch# configure terminal
Switch (config)# interface GigabitEthernet X/X
Switch (config-if) # dot1x guest-vlan
```

4.2.65.13 dot1x port-control

Command:

```
dot1x port-control auto | force-authorized | force-unauthorized | mac-based | multi |
single
```

dot1x	IEEE Standard for port-based Network Access Control
port-control	Sets the port security state.
auto	Port-based 802.1X Authentication
force-authorized	Port access is allowed
force-unauthorized	Port access is not allowed
mac-based	Switch authenticates on behalf of the client
multi	Multiple Host 802.1X Authentication
single	Single Host 802.1X Authentication

Default:

Force-authorized

Usage Guide:

To configure **Port-control** mode for 802.1X

Example:

To configure **Port-Based 802.1X(Auto)** mode for **GigabitEthernet X/X**.

```
Switch# configure terminal
Switch (config)# interface GigabitEthernet X/X
Switch (config-if) # dot1x port-control auto
```

4.2.65.14 dot1x radius-qos

Command:

```
dot1x radius-qos
```

dot1x	IEEE Standard for port-based Network Access Control
radius-qos	Enables/disables per-port state of RADIUS-assigned QoS.

Default:

Disable

Usage Guide:

To enable **RADIUS-assigned QoS** for 802.1X

Example:

To enable **RADIUS-assigned QoS** for **GigabitEthernet X/X**.

```
Switch# configure terminal
Switch (config)# interface GigabitEthernet X/X
Switch (config-if) # dot1x radius-qos
```

4.2.65.15 dot1x radius-vlan

Command:

```
dot1x radius-vlan
```

dot1x IEEE Standard for port-based Network Access Control

radius-vlan Enables/disables per-port state of RADIUS-assigned VLAN.

Default:

Disable

Usage Guide:

To enable **RADIUS-assigned VLAN** for 802.1X

Example:

To enable **RADIUS-assigned VLAN** for **GigabitEthernet X/X**.

```
Switch# configure terminal
Switch (config)# interface GigabitEthernet X/X
Switch (config-if) # dot1x radius-vlan
```

4.2.65.16 dot1x re-authenticate

Command:

```
dot1x re-authenticate
```

dot1x IEEE Standard for port-based Network Access Control

re-authenticate Refresh (restart) 802.1X authentication process.

Default:

N/A

Usage Guide:

To restart 802.1X authentication process.

Example:

To restart 802.1X authentication process for **GigabitEthernet X/X**.

```
Switch# configure terminal
Switch (config)# interface GigabitEthernet X/X
Switch (config-if) # dot1x re-authenticate
```

4.2.65.17 duplex

Command:

```
duplex auto | full | half
```

duplex Interface duplex

auto Auto negotiation of duplex mode.

full Forced full duplex.

half Forced half duplex.

Default:

Auto

Usage Guide:

To configure **duplex** mode for interface.

Example:

To configure auto **duplex** mode for **GigabitEthernet X/X**.

```
Switch# configure terminal
Switch (config)# interface GigabitEthernet X/X
Switch (config-if) # duplex auto
```

4.2.65.18 end

Command:

```
end
```

end Go back to EXEC mode

Default:

Auto

Usage Guide:

To back to **EXEC mode**

Example:

To back to **EXEC mode**

```
Switch# configure terminal
Switch (config)# interface GigabitEthernet X/X
Switch (config-if) # end
Switch#
```

4.2.65.19 evc dei

Command:

```
evc dei colored | fixed
```

- evc** Ethernet Virtual Connections
- dei** Setup DEI mode
- colored** Allow policer to set DEI
- fixed** Use classified DEI

Default:

Fixed

Usage Guide:

To configure EVC DEI mode

Example:

To configure **EVC DEI mode (Colored)** for **GigabitEthernet X/X**.

```
Switch# configure terminal
Switch (config)# interface GigabitEthernet X/X
Switch (config-if) # evc dei colored
```

4.2.65.20 evc l2cp discard(GG)

Command:

```
evc l2cp discard <L2cpDiscardList : 0~31>
```

- evc** Ethernet Virtual Connections
- l2cp** Setup L2CP forwarding
- discard** Discard L2CP frames

<L2cpDiscardList : 0~31> Select BPDU addresses (0-15) and GARP addresses (16-31)

Default:

N/A

Usage Guide:

To configure policy ID of **L2CP discard**

Example:

To configure policy ID 1 of **L2CP discard** for **GigabitEthernet X/X**.

```
Switch# configure terminal
Switch (config)# interface GigabitEthernet X/X
Switch (config-if) # evc l2cp discard 1
```

4.2.65.21 evc l2cp forward(GG)

Command:

```
evc l2cp forward <L2cpForwardList : 0~31>
```

- evc** Ethernet Virtual Connections
- l2cp** Setup L2CP forwarding
- forward** Allow forwarding of L2CP frames
- <L2cpForwardList : 0~31>** Select BPDU addresses (0-15) and GARP addresses (16-31)

Default:

N/A

Usage Guide:

To configure policy ID of **L2CP forward**

Example:

To configure policy 1 for **L2CP forward** for **GigabitEthernet X/X**

```
Switch# configure terminal
Switch (config)# interface GigabitEthernet X/X
Switch (config-if) # evc l2cp forward 1
```

4.2.65.22 evc l2cp peer(GG)

Command:

evc l2cp forward <L2cpPeerList : 0~31>

- evc** Ethernet Virtual Connections
- l2cp** Setup L2CP forwarding
- peer** Redirect L2CP frames to local protocol entity
- <L2cpPeerList : 0~31>** Select BPDU addresses (0-15) and GARP addresses (16-31)

Default:

N/A

Usage Guide:

To configure policy ID of **L2CP peer**

Example:

To configure policy 1 of **L2CP peer** for **GigabitEthernet X/X**.

```
Switch# configure terminal
Switch (config)# interface GigabitEthernet X/X
Switch (config-if) # evc l2cp peer 1
```

4.2.65.23 evc update dei

Command:

evc update dei colored | fixed

- evc** Ethernet Virtual Connections
- update** Update existing entry
- dei** Setup DEI mode
- colored** Allow policer to set DEI
- fixed** Use classified DEI

Default:

Fixed

Usage Guide:

To update EVC DEI mode

Example:

To update **EVC DEI mode (Colored)** for **GigabitEthernet X/X**.

```
Switch# configure terminal
```

```
Switch (config)# interface GigabitEthernet X/X
Switch (config-if) # evc update dei colored
```

4.2.65.24 excessive-restart

Command:

```
excessive-restart
```

excessive-restart Restart backoff algorithm after 16 collisions (No excessive-restart means discard frame after 16 collisions)

Default:

Discard

Usage Guide:

To enable **Backoff Algorithm** for the specific interface

Example:

To enable **Backoff Algorithm** for the **GigabitEthernet X/X**.

```
Switch# configure terminal
Switch (config)# interface GigabitEthernet X/X
Switch (config-if) # excessive-restart
```

4.2.65.25 exit

Command:

```
exit
```

exit Exit from current mode

Default:

None

Usage Guide:

To exit current mode

Example:

To exit current mode.

```
Switch# configure terminal
Switch (config)# interface GigabitEthernet X/X
Switch (config-if) # exit
Switch (config)#
```

4.2.65.26 flowcontrol

Command:

```
flowcontrol off | on
```

flowcontrol Traffic flow control.

off Disable flow control.

on Enable flow control.

Default:

Disable

Usage Guide:

To enable **Flow-control** for specific interface

Example:

To enable **Flow-control** for **GigabitEthernet X/X**

```
Switch# configure terminal
Switch (config)# interface GigabitEthernet X/X
Switch (config-if) # flowcontrol on
```

4.2.65.27 green-ethernet energy-detect(GG)

Command:

```
green-ethernet energy-detect
```

green-ethernet Green ethernet (Power reduction)

energy-detect Enable power saving for ports with no link partner.

Default:

N/A

Usage Guide:

To enable power saving for ports with no link partner

Example:

To enable power saving for ports with no link for **GigabitEthernet X/X**

```
Switch# configure terminal
Switch (config)# interface GigabitEthernet X/X
Switch (config-if) # green-ethernet energy-detect
```

4.2.65.28 green-ethernet short-reach(GG)

Command:

```
green-ethernet short-reach
```

green-ethernet Green ethernet (Power reduction)

short-reach Enable power saving for ports which is connect to link partner with short cable.

Default:

N/A

Usage Guide:

To enable power saving for ports with short cable

Example:

To enable power saving for ports with short cable for **GigabitEthernet X/X**

```
Switch# configure terminal
Switch (config)# interface GigabitEthernet X/X
Switch (config-if) # green-ethernet short-reach
```

4.2.65.29 gvrp join-request vlan(GG)

Command:

```
gvrp join-request vlan <vlan_list>
```

gvrp Enable GVRP on port(s)

join-request Emit a Join-Request for test purpose

Default:

N/A

Usage Guide:

To send **GVRP Join-Request** to specific interface

Example:

To send **GVRP Join-Request(VLAN 1)** to **GigabitEthernet X/X**

```
Switch# configure terminal
Switch (config)# interface GigabitEthernet X/X
Switch (config-if) # gvrp join-request vlan 1
```

4.2.65.30 gvrp leave-request vlan(GG)

Command:

```
gvrp leave-request vlan <vlan_list>
```

gvrp Enable GVRP on port(s)
leave-request Emit a Leave-Request for test purpose

Default:

N/A

Usage Guide:

To send **GVRP Leave-Request** to specific interface

Example:

To send **GVRP Leave-Request(VLAN 1)** to **GigabitEthernet X/X**

```
Switch# configure terminal
Switch (config)# interface GigabitEthernet X/X
Switch (config-if) # gvrp leave-request vlan 1
```

4.2.65.31 ip arp inspection check-vlan

Command:

```
ip arp inspection check-vlan
```

arp Address Resolution Protocol
inspection ARP inspection
check-vlan ARP inspection VLAN mode config

Default:

Disable

Usage Guide:

To configure **Check-VLAN mode** into **ARP inspection** for specific interface

Example:

To configure **Check-VLAN mode (Enabled)** into **ARP inspection** for **GigabitEthernet X/X**

```
Switch# configure terminal
Switch (config)# interface GigabitEthernet X/X
```

```
Switch (config-if) # ip arp inspection check-vlan
```

4.2.65.32 ip arp inspection logging

Command:

```
ip arp inspection logging all | deny | permit
```

arp Address Resolution Protocol

inspection ARP inspection

logging ARP inspection logging mode config

all log all entries

deny log denied entries

permit log permitted entries

Default:

None

Usage Guide:

To configure **Logging type** into **ARP inspection** for specific interface

Example:

To configure **Logging type (All)** into **ARP inspection** for **GigabitEthernet X/X**

```
Switch# configure terminal
Switch (config)# interface GigabitEthernet X/X
Switch (config-if) # ip arp inspection logging all
```

4.2.65.33 ip arp inspection trust

Command:

```
ip arp inspection trust
```

arp Address Resolution Protocol

inspection ARP inspection

trust ARP inspection trust config

Default:

Trusted

Usage Guide:

To configure Trusted into **ARP inspection** for specific interface

Example:

To configure Trusted into **ARP inspection** for **GigabitEthernet X/X**

```
Switch# configure terminal
Switch (config)# interface GigabitEthernet X/X
Switch (config-if) # ip arp inspection trust
```

4.2.65.34 ip dhcp snooping trust

Command:

```
ip dhcp snooping trust
```

Default:

Trusted

Usage Guide:

To configure Trusted into **DHCP Snooping** for specific interface

Example:

To configure Trusted into **DHCP Snooping** for **GigabitEthernet X/X**

```
Switch# configure terminal
Switch (config)# interface GigabitEthernet X/X
Switch (config-if) # ip dhcp snooping trust
```

4.2.65.35 ip igmp snooping filter

Command:

```
ip igmp snooping filter <ProfileName : word16>
```

<ProfileName : word16> Profile name in 16 words

Default:

N/A

Usage Guide:

To apply the **IGMP Snooping filter** ID for specific interface

Example:

To apply the **IGMP Snooping filter** ID 1 for **GigabitEthernet X/X**

```
Switch# configure terminal
Switch (config)# interface GigabitEthernet X/X
Switch (config-if) # ip igmp snooping filter 1
```

4.2.65.36 ip igmp snooping immediate-leave

Command:

```
ip igmp snooping immediate-leave
```

Default:

Disabled

Usage Guide:

To enable **IGMP Snooping Immediate-leave (Fast Leave)** for specific interface

Example:

To enable **IGMP Snooping Immediate-leave (Fast Leave)** for **GigabitEthernet X/X**

```
Switch# configure terminal
Switch (config)# interface GigabitEthernet X/X
Switch (config-if) # ip igmp snooping immediate-leave
```

4.2.65.37 ip igmp snooping max-groups

Command:

```
ip igmp snooping max-groups <Throttling : 1-10>
```

max-groups IGMP group throttling configuration
<Throttling : 1-10> Maximum number of IGMP group registration

Default:

Unlimited

Usage Guide:

To limit maximum number of **IGMP group** for specific interface

Example:

To limit 5 groups of **IGMP** for **GigabitEthernet X/X**

```
Switch# configure terminal
Switch (config)# interface GigabitEthernet X/X
Switch (config-if) # ip igmp snooping max-groups 5
```

4.2.65.38 ip igmp snooping mrouter

Command:

```
ip igmp snooping mrouter [ automatic | fix | none ]
```

mrouter Multicast router port configuration

automatic auto mode

fix fix mode

none none mode

Default:

Auto

Usage Guide:

To configure **Multicast router port mode** for specific interface

Example:

To configure **Multicast router port mode (fix)** for **GigabitEthernet X/X**

```
Switch# configure terminal
Switch (config)# interface GigabitEthernet X/X
Switch (config-if) # ip igmp snooping mrouter fix
```

4.2.65.39 ip verify source

Command:

```
ip verify source
```

Default:

Disabled

Usage Guide:

To enable **IP Source Guard** for specific interface

Example:

To enable **IP Source Guard** for **GigabitEthernet X/X**

```
Switch# configure terminal
Switch (config)# interface GigabitEthernet X/X
Switch (config-if) # ip verify source
```

4.2.65.40 ip verify source limit

Command:

```
ip verify source limit <0-2>
```

<0-2> the number of limit

Default:

Unlimited

Usage Guide:

To limit numbers of **Dynamic Client** for specific interface

Example:

To limit 2 numbers of **Dynamic Client** for **GigabitEthernet X/X**

```
Switch# configure terminal
Switch (config)# interface GigabitEthernet X/X
Switch (config-if) # ip verify source limit 2
```

4.2.65.41 ipv6 mld snooping filter

Command:

```
ipv6 mld snooping filter <ProfileName : word16>
```

filter Access control on MLD multicast group registration

<ProfileName : word16> Profile name in 16 words

Default:

N/A

Usage Guide:

To apply the **MLD Snooping filter** ID for specific interface

Example:

To apply the **MLD Snooping filter** ID 1 for **GigabitEthernet X/X**

```
Switch# configure terminal
Switch (config)# interface GigabitEthernet X/X
Switch (config-if) # ipv6 mld snooping filter 1
```

4.2.65.42 ipv6 mld snooping immediate-leave

Command:

```
ipv6 mld snooping immediate-leave
```

Default:

Disabled

Usage Guide:

To enable **MLD Snooping Immediate-leave (Fast Leave)** for specific interface

Example:

To enable **MLD Snooping Immediate-leave (Fast Leave)** for **GigabitEthernet X/X**

```
Switch# configure terminal
Switch (config)# interface GigabitEthernet X/X
Switch (config-if) # ipv6 mld snooping immediate-leave
```

4.2.65.43 ipv6 mld snooping max-groups

Command:

```
ipv6 mld snooping max-groups <Throttling : 1-10>
```

max-groups IGMP group throttling configuration
<Throttling : 1-10> Maximum number of IGMP group registration

Default:

Unlimited

Usage Guide:

To limit maximum number of **MLD group** for specific interface

Example:

To limit 5 groups of **MLD** for **GigabitEthernet X/X**

```
Switch# configure terminal
Switch (config)# interface GigabitEthernet X/X
Switch (config-if) # ipv6 mld snooping max-groups 5
```

4.2.65.44 ipv6 mld snooping mrouter

Command:

```
ipv6 mld snooping mrouter [ automatic | fix | none]
```

mrouter Multicast router port configuration

automatic auto mode

fix fix mode

none none mode

Default:

Auto

Usage Guide:

To configure **MLD router port mode** for specific interface

Example:

To configure **MLD router port mode (fix)** for **GigabitEthernet X/X**

```
Switch# configure terminal
Switch (config)# interface GigabitEthernet X/X
Switch (config-if) # ipv6 mld snooping mrouter fix
```

4.2.65.45 lacp

Command:

```
lacp
```

lacp Enable LACP on this interface

Default:

Disabled

Usage Guide:

To enable **LACP** for specific interface

Example:

To enable **LACP** for **GigabitEthernet X/X**

```
Switch# configure terminal
Switch (config)# interface GigabitEthernet X/X
Switch (config-if) # lacp
```

4.2.65.46 lacp key

Command:

```
lacp key <1-65535> | auto
```

lacp	Enable LACP on this interface
key	Key of the LACP aggregation
<1-65535>	Key value
auto	Choose a key based on port speed

Default:

Auto

Usage Guide:

To configure **LACP key** for specific interface

Example:

To configure **LACP key (555)** for **GigabitEthernet X/X**

```
Switch# configure terminal
Switch (config)# interface GigabitEthernet X/X
Switch (config-if) # lacp key 555
```

4.2.65.47 lacp port-priority

Command:

```
lacp port-priority <1-65535>
```

lacp	Enable LACP on this interface
port-priority	LACP priority of the port
<1-65535>	Priority value, lower means higher priority

Default:

32768

Usage Guide:

To configure **LACP port-priority** for specific interface

Example:

To configure **LACP port-priority (555)** for **GigabitEthernet X/X**

```
Switch# configure terminal
Switch (config)# interface GigabitEthernet X/X
Switch (config-if) # lacp port-priority 555
```

4.2.65.48 lacp role

Command:

```
lacp role active | passive
```

- lacp** Enable LACP on this interface
- role** Active / Passive (speak if spoken to) role
- active** Transmit LACP BPDUs continuously
- passive** Wait for neighbour LACP BPDUs before transmitting

Default:

Active

Usage Guide:

To configure **LACP role** for specific interface

Example:

To configure **LACP role** (passive) for **GigabitEthernet X/X**

```
Switch# configure terminal
Switch (config)# interface GigabitEthernet X/X
Switch (config-if) # lacp role passive
```

4.2.65.49 lacp timeout

Command:

```
lacp timeout fast | slow
```

- lacp** Enable LACP on this interface
- timeout** The period between BPDU transmissions
- fast** Transmit BPDU each second (fast timeout)
- slow** Transmit BPDU each 30th second (slow timeout)

Default:

Fast

Usage Guide:

To configure **LACP timeout** type for specific interface

Example:

To enable **LACP timeout** type (slow) for **GigabitEthernet X/X**

```
Switch# configure terminal
Switch (config)# interface GigabitEthernet X/X
```

```
Switch (config-if) # lacp timeout slow
```

4.2.65.50 lldp cdp-aware

Command:

```
lldp cdp-aware
```

lldp LLDP configurations

cdp-aware Configures if the interface shall be CDP aware (CDP discovery information is added to the LLDP neighbor table)

Default:

Passive

Usage Guide:

To configure **MIB variable retrieve** local info or remote info of **LLDP** for specific interface

Example:

To configure **MIB variable retrieve** (local info) of **LLDP** for **GigabitEthernet X/X**

```
Switch# configure terminal
Switch (config)# interface GigabitEthernet X/X
Switch (config-if) # lldp cdp-aware
```

4.2.65.51 lldp med media-vlan policy-list

Command:

```
lldp med media-vlan policy-list <v_range_list>
```

lldp LLDP configurations

med Media Endpoint Discovery

media-vlan Media VLAN assignment

policy-list Assignment of policies

<v_range_list> Policies to assign to the interface

Default:

N/A

Usage Guide:

To apply **MED Media-VLAN** policy of **LLDP** for specific interface

Example:

To apply **MED Media-VLAN** policy 2 of **LLDP** for **GigabitEthernet X/X**

```
Switch# configure terminal
Switch (config)# interface GigabitEthernet X/X
Switch (config-if) # Ildp med media-vlan policy-list 2
```

4.2.65.52 Ildp med transmit-tlv

Command:

```
Ildp med transmit-tlv [ capabilities ] [ location ] [ network-policy ]
```

Ildp LLDP configurations

med Media Endpoint Discovery

transmit-tlv LLDP-MED Location Type Length Value parameter.

capabilities Enable transmission of the optional capabilities TLV.

location Enable transmission of the optional location TLV.

network-policy Enable transmission of the optional network-policy TLV.

Default:

N/A

Usage Guide:

To configure **LLDP-MED TLV Type** for specific interface

Example:

To enable **LLDP-MED TLV (capabilities and location)** for **GigabitEthernet X/X**

```
Switch# configure terminal
Switch (config)# interface GigabitEthernet X/X
Switch (config-if) # Ildp med transmit-tlv capabilities location
```

4.2.65.53 Ildp receive

Command:

```
Ildp receive
```

Ildp LLDP configurations

receive Enable/Disable decoding of received LLDP frames.

Default:

Both (Tx +Rx)

Usage Guide:

To configure **LLDP Rx only mode** for specific interface

Example:

To configure **LLDP Rx only mode** for **GigabitEthernet X/X**

```
Switch# configure terminal
Switch (config)# interface GigabitEthernet X/X
Switch (config-if) # lldp receive
```

4.2.65.54 lldp tlv-select management-address

Command:

```
lldp tlv-select management-address
```

- lldp** LLDP configurations
- tlv-select** To transmit which optional TLVs.
- management-address** Enable/Disable transmission of management address.

Default:

Enabled

Usage Guide:

To enable **management address** of **LLDP TLV** for specific interface

Example:

To enable **management address** of **LLDP TLV** for **GigabitEthernet X/X**

```
Switch# configure terminal
Switch (config)# interface GigabitEthernet X/X
Switch (config-if) # lldp tlv-select management-address
```

4.2.65.55 lldp tlv-select port-description

Command:

```
lldp tlv-select port-description
```

- lldp** LLDP configurations
- tlv-select** To transmit which optional TLVs.
- port-description** Enable/Disable transmission of port description.

Default:

Enabled

Usage Guide:

To enable **port-description** of **LLDP TLV** for specific interface

Example:

To enable **port-description** of **LLDP TLV** for **GigabitEthernet X/X**

```
Switch# configure terminal
Switch (config)# interface GigabitEthernet X/X
Switch (config-if) # lldp tlv-select port-description
```

4.2.65.56 lldp tlv-select system-capabilities

Command:

```
lldp tlv-select system-capabilities
```

lldp LLDP configurations

tlv-select To transmit which optional TLVs.

system-capabilities Enable/Disable transmission of system capabilities.

Default:

Enabled

Usage Guide:

To enable **system-capabilities** of **LLDP TLV** for specific interface

Example:

To enable **system-capabilities** of **LLDP TLV** for **GigabitEthernet X/X**

```
Switch# configure terminal
Switch (config)# interface GigabitEthernet X/X
Switch (config-if) # lldp tlv-select system-capabilities
```

4.2.65.57 lldp tlv-select system-description

Command:

```
lldp tlv-select system-description
```

lldp LLDP configurations

tlv-select To transmit which optional TLVs.

system-description Enable/Disable transmission of system description.

Default:

Enabled

Usage Guide:

To enable **system-description** of **LLDP TLV** for specific interface

Example:

To enable **system-description** of **LLDP TLV** for **GigabitEthernet X/X**

```
Switch# configure terminal
Switch (config)# interface GigabitEthernet X/X
Switch (config-if) # lldp tlv-select system-description
```

4.2.65.58 lldp tlv-select system-name

Command:

```
lldp tlv-select system-name
```

lldp LLDP configurations
tlv-select To transmit which optional TLVs.
system-name Enable/Disable transmission of system name.

Default:

Enabled

Usage Guide:

To enable **system-name** of **LLDP TLV** for specific interface

Example:

To enable **system-name** of **LLDP TLV** for **GigabitEthernet X/X**

```
Switch# configure terminal
Switch (config)# interface GigabitEthernet X/X
Switch (config-if) # lldp tlv-select system-name
```

4.2.65.59 lldp transmit

Command:

```
lldp transmit
```

lldp LLDP configurations
transmit Enable/Disabled transmission of LLDP frames.

Default:

Both (Tx +Rx)

Usage Guide:

To configure **LLDP Tx only mode** for specific interface

Example:

To configure **LLDP Tx only mode** for **GigabitEthernet X/X**

```
Switch# configure terminal
Switch (config)# interface GigabitEthernet X/X
Switch (config-if) # lldp transmit
```

4.2.65.60 loop-protect

Command:

```
loop-protect
```

loop-protect Loop protection configuration

Default:

Enabled

Usage Guide:

To enable **loop-protect** for specific interface

Example:

To enable **loop-protect** for **GigabitEthernet X/X**

```
Switch# configure terminal
Switch (config)# interface GigabitEthernet X/X
Switch (config-if) # loop-protect
```

4.2.65.61 loop-protect action

Command:

```
loop-protect action [log] [shutdown]
```

loop-protect Loop protection configuration

action Action if loop detected

log Generate log

shutdown Shutdown port

Default:

Shutdown

Usage Guide:

To configure **action mode** of **Loop protection** for specific interface

Example:

To configure **action mode (log and shutdown)** of **Loop protection** for **GigabitEthernet X/X**

```
Switch# configure terminal
Switch (config)# interface GigabitEthernet X/X
Switch (config-if) # loop-protect action shutdown log
```

4.2.65.62 loop-protect tx-mode

Command:

```
loop-protect tx-mode
```

loop-protect Loop protection configuration

tx-mode Actively generate PDUs

Default:

Enabled

Usage Guide:

To enable **tx-mode** of **Loop protection** for specific interface

Example:

To enable **tx-mode** of **Loop protection** for **GigabitEthernet X/X**

```
Switch# configure terminal
Switch (config)# interface GigabitEthernet X/X
Switch (config-if) # loop-protect tx-mode
```

4.2.65.63 loop-protect tx-mode

Command:

```
loop-protect tx-mode
```

loop-protect Loop protection configuration

tx-mode Actively generate PDUs

Default:

Enabled

Usage Guide:

To enable **tx-mode** of **Loop protection** for specific interface

Example:

To enable **tx-mode** of **Loop protection** for **GigabitEthernet X/X**

```
Switch# configure terminal
Switch (config)# interface GigabitEthernet X/X
Switch (config-if) # loop-protect tx-mode
```

4.2.65.64 mac address-table learning

Command:

```
mac address-table learning [secure]
```

mac MAC keyword
address-table MAC table configuration
learning Port learning mode
secure Port Secure mode

Default:

Enabled (Auto)

Usage Guide:

To enable **learning** of **MAC address table** for specific interface

Example:

To enable **learning** of **MAC address table** for **GigabitEthernet X/X**

```
Switch# configure terminal
Switch (config)# interface GigabitEthernet X/X
Switch (config-if) # mac address-table learning
```

4.2.65.65 media-type

Command:

```
media-type dual | rj45 | sfp
```

media-type Media type.
dual Dual media interface (copper & fiber interface).

rj45 rj45 interface (copper interface).

sfp sfp interface (fiber interface).

Default:

N/A

Usage Guide:

To configure **Copper** or **Fiber mode** of **media type** for specific interface

Example:

To configure **Copper mode** of **media type** for **GigabitEthernet X/X**

```
Switch# configure terminal
Switch (config)# interface GigabitEthernet X/X
Switch (config-if) # media-type rj45
```

4.2.65.66 mtu

Command:

```
mtu <1518-10056>
```

mtu Maximum transmission unit

<1518-10056> Maximum frame size in bytes.

Default:

10056

Usage Guide:

To configure **MTU sizes** for specific interface

Example:

To configure **MTU sizes (9000)** for **GigabitEthernet X/X**

```
Switch# configure terminal
Switch (config)# interface GigabitEthernet X/X
Switch (config-if) # mtu 9000
```

4.2.65.67 mvr immediate-leave

Command:

```
mvr immediate-leave
```

mvr Multicast VLAN Registration configuration

immediate-leave Immediate leave configuration

Default:

Disabled

Usage Guide:To enable **Immediate-leave of MVR** for specific interface**Example:**To enable **Immediate-leave of MVR** for **GigabitEthernet X/X**

```
Switch# configure terminal
Switch (config)# interface GigabitEthernet X/X
Switch (config-if) # mvr immediate-leave
```

4.2.65.68 mvr name

Command:

```
mvr name <MvrName : word16> type [receiver | source]
```

mvr Multicast VLAN Registration configuration

name MVR multicast name

<MvrName : word16> MVR multicast VLAN name

type MVR port role configuration

receiver MVR receiver port

source MVR source port

Default:

Inactive

Usage Guide:To configure **port role** of specific **MVR profile** for specific interface**Example:**To configure **port role (source)** of **MVR profiles (111)** for **GigabitEthernet X/X**

```
Switch# configure terminal
Switch (config)# interface GigabitEthernet X/X
Switch (config-if) # mvr name 111 type source
```

4.2.65.69 mvr vlan

Command:

```
mvr vlan <v_vlan_list> type [source | receiver ]
```

mvr Multicast VLAN Registration configuration
vlan MVR multicast vlan
<vlan_list> MVR multicast VLAN list
type MVR port role configuration
receiver MVR receiver port
source MVR source port

Default:

Inactive

Usage Guide:

To configure **port role** of specific **MVR VLAN ID** for specific interface

Example:

To configure **port role (source)** of **MVR VLAN ID (111)** for **GigabitEthernet X/X**

```
Switch# configure terminal
Switch (config)# interface GigabitEthernet X/X
Switch (config-if) # mvr name 111 type source
```

4.2.65.70 network-clock synchronization ssm

Command:

```
network-clock synchronization ssm
```

network-clock network-clock
synchronization SSM enable/disable.
ssm SSM enable/disable.

Default:

Disable

Usage Guide:

To enable **SSM** of **SyncE** for specific interface

Example:

To enable **SSM** of **SyncE** for **GigabitEthernet X/X**

```
Switch# configure terminal
Switch (config)# interface GigabitEthernet X/X
```

```
Switch (config-if) # network-clock synchronization ssm
```

4.2.65.71 no

Command:

```
no
```

no Negate a command or set its defaults

Default:

N/A

Usage Guide:

To default the function for specific interface

Example:

To enable the function (**network-clock synchronization ssm**) for **GigabitEthernet X/X**.

```
Switch# configure terminal
Switch (config)# interface GigabitEthernet X/X
Switch (config-if) # no network-clock synchronization ssm
```

4.2.65.72 ping ip

Command:

```
ping ip <ipv4_addr> size <size: 2-1452>
```

ping The ping command allows you to test connectivity to a network host from the appliance

ip ip

<ipv4_addr> IP address

size size

<size: 2-1452> Default is 56 (excluding MAC, IP and ICMP headers)

Default:

N/A

Usage Guide:

To run Ping function for specific interface

Example:

To run Ping function (IP address: 10.10.10.10 with size 88 bytes) for **GigabitEthernet X/X**.

```
Switch# configure terminal
Switch (config)# interface GigabitEthernet X/X
Switch (config-if) # ping ip 10.10.10.10 size 88
```

4.2.65.73 poe mode

Command:

```
poe mode { standard | plus }
```

poe Power Over Ethernet.

mode PoE mode.

plus Set mode to PoE+ (Maximum power 30.0 W)

standard Set mode to PoE (Maximum power 15.4 W)

Default:

N/A

Usage Guide:

To configure 802.3at/af mode for specific interface

Example:

To configure 802.3at mode for **GigabitEthernet X/X**.

```
Switch# configure terminal
Switch (config)# interface GigabitEthernet X/X
Switch (config-if) # poe mode plus
```

4.2.65.74 poe pdcheck IP

Command:

```
poe pdcheck IP <ipv4_addr>
```

poe Power Over Ethernet.

pdcheck Allows user to enable or disable per port PD Alive Check function.

IP To set PoE device IP address here for system making ping to the PoE device.

<ipv4_addr> <ipv4_addr>

Default:

N/A

Usage Guide:

To configure **Ping PD IP Address** of **PoE** for specific interface

Example:

To configure **Ping PD IP Address** (10.101.10.10) of **PoE** for **GigabitEthernet X/X**.

```
Switch# configure terminal
Switch (config)# interface GigabitEthernet X/X
Switch (config-if) # poe pdcheck IP 10.101.10.10
```

4.2.65.75 poe pdcheck action

Command:

```
poe pdcheck action { reboot | alarm | reboot-alarm }
```

- poe** Power Over Ethernet.
- pdcheck** Allows user to enable or disable per port PD Alive Check function.
- action** Allows user to set which action will be applied if the PD is without any response
- alarm** It means system will issue an alarm message via Syslog, SMTP.
- reboot** It means system will reset the PoE port that is connected to the PD.
- reboot-alarm** It means system will reset the PoE port and issue an alarm message via Syslog, SMTP.

Default:

N/A

Usage Guide:

To configure **PD Ping Alive Check Action** of **PoE** for specific interface

Example:

To configure **PD Ping Alive Check Action (Alarm)** of **PoE** for **GigabitEthernet X/X**.

```
Switch# configure terminal
Switch (config)# interface GigabitEthernet X/X
Switch (config-if) # poe pdcheck action alarm
```

4.2.65.76 poe pdcheck enable

Command:

```
poe pdcheck enable
```

- poe** Power Over Ethernet.
- pdcheck** Allows user to enable or disable per port PD Alive Check function.
- enable** PD alive check enable.

Default:

Disabled

Usage Guide:

To enable **PD Ping Alive Check** function of **PoE** for specific interface.

Example:

To enable **PD Ping Alive Check** function of **PoE** for **GigabitEthernet X/X**.

```
Switch# configure terminal
Switch (config)# interface GigabitEthernet X/X
Switch (config-if) # poe pdcheck enable
```

4.2.65.77 poe pdcheck interval

Command:

```
poe pdcheck interval <10-300>
```

- poe** Power Over Ethernet.
- pdcheck** Allows user to enable or disable per port PD Alive Check function.
- interval** set how long system should be issue a ping request to PD for detecting whether PD is alive or dead.
- <10-300>** interval <10~300>

Default:

30

Usage Guide:

To configure **PD Ping Alive Check** interval of **PoE** for specific interface.

Example:

To configure **PD Ping Alive Check** interval (100 seconds) of **PoE** for **GigabitEthernet X/X**.

```
Switch# configure terminal
```

```
Switch (config)# interface GigabitEthernet X/X
Switch (config-if) # poe pdcheck interval 100
```

4.2.65.78 poe pdcheck reboot-time

Command:

```
poe pdcheck reboot-time <30-180>
```

poe Power Over Ethernet.

pdcheck Allows user to enable or disable per port PD Alive Check function.

reboot-time set the PoE device rebooting time.

<30-180> reboot-time <30-180>

Default:

90

Usage Guide:

To configure **PD Ping Alive Check** rebooting time of **PoE** for specific interface.

Example:

To configure **PD Ping Alive Check** rebooting time (100 seconds) of **PoE** for **GigabitEthernet X/X**.

```
Switch# configure terminal
Switch (config)# interface GigabitEthernet X/X
Switch (config-if) # poe pdcheck reboot-time 100
```

4.2.65.79 poe pdcheck retry-count

Command:

```
poe pdcheck retry-count <1-5>
```

poe Power Over Ethernet.

pdcheck Allows user to enable or disable per port PD Alive Check function.

retry-count set how many times system retry ping to PD.

<1-5> retry-count <1-5>

Default:

2

Usage Guide:

To configure **PD Ping Alive Check** retry count of **PoE** for specific interface.

Example:

To configure **PD Ping Alive Check** retry count (5) of **PoE** for **GigabitEthernet X/X**.

```
Switch# configure terminal
Switch (config)# interface GigabitEthernet X/X
Switch (config-if) # poe pdcheck retry-count 5
```

4.2.65.80 poe power limit

Command:

```
poe power limit { <Power in watts>}
```

- poe** Power Over Ethernet.
- power** Setting maximum power for port in allocation mode.
- limit** The maximum power.
- <Power in watts : option>** Maximum power for the interface (0-15.4 Watt for PoE standard mode, 0-30.0 Watt for PoE plus mode)

Default:

2

Usage Guide:

To configure maximum power of **PoE** for specific interface.

Example:

To configure maximum power (29 watts) of **PoE** for **GigabitEthernet X/X**.

```
Switch# configure terminal
Switch (config)# interface GigabitEthernet X/X
Switch (config-if) # poe power limit 29
```

4.2.65.81 poe priority

Command:

```
poe priority { low | high | critical }
```

- poe** Power Over Ethernet.
- priority** Interface priority.
- critical** Set priority to critical.
- high** Set priority to high.
- low** Set priority to low.

Default:

Usage Guide:

To configure interface priority of **PoE** for specific interface.

Example:

To configure interface priority (low) of **PoE** for **GigabitEthernet X/X**.

```
Switch# configure terminal
Switch (config)# interface GigabitEthernet X/X
Switch (config-if) # poe priority low
```

4.2.65.82 poe time-range

Command:

```
poe time-range { profile1 | profile2 | profile3 | profile4 }
```

poe Power Over Ethernet.

time-range To bind a PoE time-range to the corresponding port.

profile1 The profile name of the PoE time-range to be bound to the port.

profile2 The profile name of the PoE time-range to be bound to the port.

profile3 The profile name of the PoE time-range to be bound to the port.

profile4 The profile name of the PoE time-range to be bound to the port.

Default:

Profile 1

Usage Guide:

To configure time-range profile of **PoE** for specific interface.

Example:

To configure time-range profile (Profile 3) of **PoE** for **GigabitEthernet X/X**.

```
Switch# configure terminal
Switch (config)# interface GigabitEthernet X/X
Switch (config-if) # poe time-range profile3
```

4.2.65.83 port-security

Command:

```
port-security
```

port-security Enable/disable port security per interface.

Default:

Disabled

Usage Guide:To enable **Port-security** for specific interface**Example:**To enable **Port-security** for **GigabitEthernet X/X**

```
Switch# configure terminal
Switch (config)# interface GigabitEthernet X/X
Switch (config-if) # port-security
```

4.2.65.84 port-security maximum

Command:

```
port-security maximum <Number of addresses : 1-1024>
```

port-security Enable/disable port security per interface.**maximum** Maximum number of MAC addresses that can be learned on this set of interfaces.**<Number of addresses : 1-1024>** Number of addresses**Default:**

None

Usage Guide:To configure number of **Port-security** addresses for specific interface**Example:**To configure 100 **Port-security** addresses for **GigabitEthernet X/X**

```
Switch# configure terminal
Switch (config)# interface GigabitEthernet X/X
Switch (config-if) # port-security maximum 100
```

4.2.65.85 port-security violation

Command:

```
port-security violation [protect | shutdown | trap | trap-shutdown]
```

port-security Enable/disable port security per interface.

violation	The action involved with exceeding the limit.
protect	Don't do anything
shutdown	Shut down the port
trap	Send an SNMP trap
trap-shutdown	Send an SNMP trap and shut down the port

Default:

None (Protected)

Usage Guide:

To configure protected mode of **Port-security** for specific interface

Example:

To configure protected mode (**trap-shutdown**) of **Port-security** for **GigabitEthernet X/X**

```
Switch# configure terminal
Switch (config)# interface GigabitEthernet X/X
Switch (config-if) # port-security violation trap-shutdown
```

4.2.65.86 port-security violation

Command:

```
port-security violation [protect | shutdown | trap | trap-shutdown]
```

port-security	Enable/disable port security per interface.
violation	The action involved with exceeding the limit.
protect	Don't do anything
shutdown	Shutdown the port
trap	Send an SNMP trap
trap-shutdown	Send an SNMP trap and shut down the port

Default:

None (Protected)

Usage Guide:

To configure protected mode of **Port-security** for specific interface

Example:

To configure protected mode (**trap-shutdown**) of **Port-security** for **GigabitEthernet X/X**

```
Switch# configure terminal
Switch (config)# interface GigabitEthernet X/X
Switch (config-if) # port-security violation trap-shutdown
```

4.2.65.87 pvlan

Command:

```
pvlan <range_list>
```

pvlan Private VLAN

<range_list> list of PVLANS. Range is from 1 to number of ports.

Default:

None

Usage Guide:

To create PVLAN ID for specific interface

Example:

To create PVLAN ID (5) for **GigabitEthernet X/X**

```
Switch# configure terminal
Switch (config)# interface GigabitEthernet X/X
Switch (config-if) # pvlan 5
```

4.2.65.88 pvlan isolation

Command:

```
pvlan isolation
```

pvlan Private VLAN

isolation Port isolation

Default:

None

Usage Guide:

To enable **PVLAN isolation** for specific interface

Example:

To enable **PVLAN isolation** for **GigabitEthernet X/X**

```
Switch# configure terminal
Switch (config)# interface GigabitEthernet X/X
Switch (config-if) # pvlan isolation
```

4.2.65.89 qos cos

Command:

```
qos cos <Cos : 0-7>
```

qos Quality of Service
cos Class of service configuration
<Cos : 0-7> Specific class of service

Default:

0

Usage Guide:

To configure **CoS** of **QoS** for specific interface

Example:

To configure **CoS** (4) of **QoS** for **GigabitEthernet X/X**

```
Switch# configure terminal
Switch (config)# interface GigabitEthernet X/X
Switch (config-if) # qos cos 4
```

4.2.65.90 qos dei

Command:

```
qos dei <Dei : 0-1>
```

qos Quality of Service
dei Drop Eligible Indicator configuration
<Dei : 0-1> Specific Drop Eligible Indicator

Default:

0

Usage Guide:

To configure **DEI** of **QoS** for specific interface

Example:

To configure **DEI** (1) of **QoS** for **GigabitEthernet X/X**

```
Switch# configure terminal
Switch (config)# interface GigabitEthernet X/X
Switch (config-if) # qos dei 1
```

4.2.65.91 qos dpl

Command:

```
qos dpl <Dei : 0-1>
```

qos Quality of Service
dpl Drop precedence level configuration
<Dpl : dpl> Specific drop precedence level

Default:

0

Usage Guide:

To configure **DPL** of **QoS** for specific interface

Example:

To configure **DPL** (1) of **QoS** for **GigabitEthernet X/X**

```
Switch# configure terminal
Switch (config)# interface GigabitEthernet X/X
Switch (config-if) # qos dpl 1
```

4.2.65.92 qos dscp-classify

Command:

```
qos dscp-classify any | selected | zero
```

qos Quality of Service
dscp-classify DSCP ingress classification
any Classify to new DSCP always
selected Classify to new DSCP if classify is enabled for specific DSCP value in global dscp-classify map
zero Classify to new DSCP if DSCP is 0

Default:

Disabled

Usage Guide:

To configure **DSCP Classify** of **QoS** for specific interface

Example:

To configure **DSCP Classify (Any)** of **QoS** for **GigabitEthernet X/X**

```
Switch# configure terminal
Switch (config)# interface GigabitEthernet X/X
Switch (config-if) # qos dscp-classify any
```

4.2.65.93 qos dscp-remark

Command:

```
qos dscp-remark remap | rewrite
```

- qos** Quality of Service
- dscp-remark** DSCP egress remarking
- remap** Rewrite DSCP field using classified DSCP remapped through global dscp-egress-translation map
- rewrite** Rewrite DSCP field with classified DSCP value (no translation)

Default:

Disabled

Usage Guide:

To configure **DSCP egress remarking** of **QoS** for specific interface

Example:

To configure **DSCP egress remarking (Remap)** of **QoS** for **GigabitEthernet X/X**

```
Switch# configure terminal
Switch (config)# interface GigabitEthernet X/X
Switch (config-if) # qos dscp-remark remap
```

4.2.65.94 qos dscp-translate

Command:

```
qos dscp-translate
```

- qos** Quality of Service
- dscp-translate** DSCP ingress translation

Default:

Disabled

Usage Guide:

To configure **DSCP ingress translation of QoS** for specific interface

Example:

To configure **DSCP ingress translation of QoS** for **GigabitEthernet X/X**

```
Switch# configure terminal
Switch (config)# interface GigabitEthernet X/X
Switch (config-if) # qos dscp-translate
```

4.2.65.95 qos map cos-tag

Command:

```
qos map cos-tag cos <Cos : 0~7> dpl <Dpl : 0~1> pcp <Pcp : 0-7> dei <Dei : 0-1>
```

- qos** Quality of Service
- map** QoS Map/Table configuration
- cos-tag** Map for cos to tag configuration
- cos** Specify class of service
- <Cos : 0~7>** Specific class of service or range
- dpl** Specify drop precedence level
- <Dpl : 0~1>** Specific drop precedence level or range
- pcp** Specify PCP (Priority Code Point)
- <Pcp : 0-7>** Specific PCP
- dei** Specify DEI (Drop Eligible Indicator)
- <Dei : 0-1>** Specific DEI

Default:

Disabled

Usage Guide:

To configure **(QoS class, DP level) to (PCP, DEI) Mapping of QoS** for specific interface

Example:

To configure **(QoS class, DP level) to (PCP, DEI) Mapping of QoS** as below table for **GigabitEthernet X/X**

QoS class	DP level	PCP	DEI
1	1	6	0

```
Switch# configure terminal
Switch (config)# interface GigabitEthernet X/X
```



```
Switch (config-if) # qos map cos-tag cos 1 dpl 1 pcp 6 dei 0
```

4.2.65.96 qos map tag-cos

Command:

```
qos map tag-cos pcp <Pcp : 0-7> dei <Dei : 0-1> cos <Cos : 0-7> dpl <Dpl : 0-1>
```

qos Quality of Service

map QoS Map/Table configuration

tag-cos Map for tag to cos configuration

pcp Specify PCP (Priority Code Point)

<Pcp : 0-7> Specific PCP

dei Specify DEI (Drop Eligible Indicator)

<Dei : 0-1> Specific DEI

cos Specify class of service

<Cos : 0-7> Specific class of service or range

dpl Specify drop precedence level

<Dpl : 0-1> Specific drop precedence level or range

Default:

Disabled

Usage Guide:

To configure **(PCP, DEI) to (QoS class, DP level) Mapping of QoS** for specific interface

Example:

To configure **(PCP, DEI) to (QoS class, DP level) Mapping of QoS** as below table for **GigabitEthernet X/X**

PCP	DEI	QoS class	DP level
4	0	5	1

```
Switch# configure terminal
Switch (config)# interface GigabitEthernet X/X
Switch (config-if) # qos map tag-cos pcp 4 dei 0 cos 5 dpl 1
```

4.2.65.97 qos pcp

Command:

```
qos pcp <Pcp : 0-7>
```

qos Quality of Service

pcp Priority Code Point configuration
<Pcp : 0-7> Specific Priority Code Point

Default:

0

Usage Guide:

To configure **PCP** of **QoS** for specific interface

Example:

To configure **PCP (6)** of **QoS** for **GigabitEthernet X/X**

```
Switch# configure terminal
Switch (config)# interface GigabitEthernet X/X
Switch (config-if) # qos pcp 6
```

4.2.65.98 qos policer

Command:

```
qos policer <Rate : 100-13200000>
```

qos Quality of Service
policer Policer configuration
<Rate : 100-13200000> Policer rate (default kbps)

Default:

0

Usage Guide:

To configure **Ingress Port Policers Rate** of **QoS** for specific interface

Example:

To configure **Ingress Port Policers Rate (9999 Kbps)** of **QoS** for **GigabitEthernet X/X**

```
Switch# configure terminal
Switch (config)# interface GigabitEthernet X/X
Switch (config-if) # qos policer 9999
```

4.2.65.99 qos queue-policer queue

Command:

```
qos queue-policer queue <Queue : 0~7> <Rate : 100-13200000>
```

qos Quality of Service
queue-policer Queue policer configuration
queue Specify queue
<Queue : 0~7> Specific queue or range
<Rate : 100-13200000> Policer rate in kbps

Default:

0

Usage Guide:

To configure **Ingress Queue Policers Rate** of **QoS** for specific interface

Example:

To configure **Ingress Queue (4) Policers Rate (9999 Kbps)** of **QoS** for **GigabitEthernet X/X**

```
Switch# configure terminal
Switch (config)# interface GigabitEthernet X/X
Switch (config-if) # qos queue-policer queue 4 9999
```

4.2.65.100 qos queue-shaper queue

Command:

```
qos queue-shaper queue <Queue : 0~7> <Rate : 100-13200000>
```

qos Quality of Service
queue-shaper Queue shaper configuration
queue Specify queue
<Queue : 0~7> Specific queue or range
<Rate : 100-13200000> Policer rate in kbps

Default:

0

Usage Guide:

To configure **Egress Queue Shapers Rate** of **QoS** for specific interface

Example:

To configure **Egress Queue (4) Shapers Rate (9999 Kbps)** of **QoS** for **GigabitEthernet X/X**

```
Switch# configure terminal
Switch (config)# interface GigabitEthernet X/X
Switch (config-if) # qos queue-shaper queue 4 9999
```

4.2.65.101 qos shaper

Command:

```
qos shaper <Rate : 100-13200000>
```

- qos** Quality of Service
- shaper** Shaper configuration
- <Rate : 100-13200000>** Shaper rate in kbps

Default:

0

Usage Guide:

To configure **Egress Port Shapers Rate** of **QoS** for specific interface

Example:

To configure **Egress Port (4) Shapers Rate (9999 Kbps)** of **QoS** for **GigabitEthernet X/X**

```
Switch# configure terminal
Switch (config)# interface GigabitEthernet X/X
Switch (config-if) # qos queue-shaper queue 4 9999
```

4.2.65.102 qos storm broadcast

Command:

```
qos storm broadcast <Rate : 100-13200000> [fps]
```

- qos** Quality of Service
- storm** Storm policer
- broadcast** Police broadcast frames
- <Rate : 100-13200000>** Policer rate (default kbps)
- fps** Rate is fps

Default:

500

Usage Guide:

To configure **Broadcast Frames Storm Control Rate** of **QoS** for specific interface

Example:

To configure **Broadcast Frames Storm Control Rate** (999 fps) of **QoS** for **GigabitEthernet X/X**

```
Switch# configure terminal
Switch (config)# interface GigabitEthernet X/X
Switch (config-if) # qos storm broadcast 999 fps
```

4.2.65.103 qos storm unicast

Command:

```
qos storm unicast <Rate : 100-13200000> [fps]
```

- qos** Quality of Service
- storm** Storm policer
- unicast** Police unicast frames
- <Rate : 100-13200000>** Policer rate (default kbps)
- fps** Rate is fps

Default:

500

Usage Guide:

To configure **Unicast Frames Storm Control Rate** of **QoS** for specific interface

Example:

To configure **Unicast Frames Storm Control Rate** (999 Kbps) of **QoS** for **GigabitEthernet X/X**

```
Switch# configure terminal
Switch (config)# interface GigabitEthernet X/X
Switch (config-if) # qos storm unicast 999
```

4.2.65.104 qos storm unknown

Command:

```
qos storm unknown <Rate : 100-13200000> [fps]
```

- qos** Quality of Service
- storm** Storm policer

unknown Police unknown (flooded) frames
<Rate : 100-13200000> Policer rate (default kbps)
fps Rate is fps

Default:

500

Usage Guide:

To configure **Unknown Frames Storm Control Rate** of **QoS** for specific interface

Example:

To configure **Unknown Frames Storm Control Rate** (999 fps) of **QoS** for **GigabitEthernet X/X**

```
Switch# configure terminal
Switch (config)# interface GigabitEthernet X/X
Switch (config-if) # qos storm unicast 999 fps
```

4.2.65.105 qos tag-remark

Command:

```
qos tag-remark pcp <Pcp : 0-7> dei <Dei : 0-1>
```

qos Quality of Service
tag-remark Tag remarking configuration
pcp Specify default PCP
<Pcp : 0-7> Specific PCP
dei Specify default DEI
<Dei : 0-1> Specific DEI

Default:

0

Usage Guide:

To enable **Tag-remark default mode** of **QoS** for specific interface

Example:

To enable **Tag-remark default mode** (PCP:1 , DEI:1) of **QoS** for **GigabitEthernet X/X**

```
Switch# configure terminal
Switch (config)# interface GigabitEthernet X/X
Switch (config-if) # qos tag-remark pcp 1 dei 1
```

4.2.65.106 qos tag-remark mapped

Command:

```
qos tag-remark mapped
```

qos Quality of Service
tag-remark Tag remarking configuration
mapped Used mapped values (cos,dpl -> pcp,dei)

Default:

Classified

Usage Guide:

To enable **Tag-remark mapped mode** of **QoS** for specific interface

Example:

To enable **Tag-remark mapped mode** of **QoS** for **GigabitEthernet X/X**

```
Switch# configure terminal
Switch (config)# interface GigabitEthernet X/X
Switch (config-if) # qos tag-remark mapped
```

4.2.65.107 qos trust dscp

Command:

```
qos trust dscp
```

qos Quality of Service
trust Trust configuration
dscp DSCP value

Default:

Disabled

Usage Guide:

To enable **DSCP Classification** of **QoS** for specific interface

Example:

To enable **DSCP Classification** of **QoS** for **GigabitEthernet X/X**

```
Switch# configure terminal
Switch (config)# interface GigabitEthernet X/X
Switch (config-if) # qos trust dscp
```

4.2.65.108 qos trust tag

Command:

```
qos trust tag
```

qos Quality of Service
trust Trust configuration
tag VLAN tag

Default:

Disabled

Usage Guide:

To enable **VLAN tag Classification** of **QoS** for specific interface

Example:

To enable **VLAN tag Classification** of **QoS** for **GigabitEthernet X/X**

```
Switch# configure terminal
Switch (config)# interface GigabitEthernet X/X
Switch (config-if) # qos trust tag
```

4.2.65.109 rmon collection history

Command:

```
rmon collection history <1-65535> buckets <1-65535> interval <1-3600>
```

rmon Configure Remote Monitoring on an interface
collection Configure Remote Monitoring Collection on an interface
history Configure history
buckets Requested buckets of intervals. Default is 50 buckets
interval Interval to sample data for each bucket. Default is 1800 seconds

Default:

N/A

Usage Guide:

To configure **RMON History Configuration** for specific interface

Example:

To configure **RMON History Configuration** as below table for **GigabitEthernet X/X**

ID	Data Source	Interval	Buckets
1	.1.3.6.1.2.1.2.2.1.1. X	3	5

```
Switch# configure terminal
Switch (config)# interface GigabitEthernet X/X
Switch (config-if) # rmon collection history 1 buckets 5 interval 3
```

4.2.65.110 rmon collection stats

Command:

```
rmon collection stats <1-65535>
```

- rmon** Configure Remote Monitoring on an interface
- collection** Configure Remote Monitoring Collection on an interface
- stats** Configure statistics

Default:

0

Usage Guide:

To configure **RMON Statistics Configuration** for specific interface

Example:

To configure **RMON Statistics Configuration (2)** as below table for **GigabitEthernet X/X**

ID	Data Source
2	.1.3.6.1.2.1.2.2.1.1. X

```
Switch# configure terminal
Switch (config)# interface GigabitEthernet X/X
Switch (config-if) # rmon collection stats 2
```

4.2.65.111 shutdown

Command:

```
shutdown
```

shutdown Shutdown of the interface.

Default:

No shutdown

Usage Guide:

To shut down specific interface

Example:

To shut down **GigabitEthernet X/X**

```
Switch# configure terminal
Switch (config)# interface GigabitEthernet X/X
Switch (config-if) # shutdown
```

4.2.65.112 spanning-tree

Command:

```
spanning-tree
```

spanning-tree Spanning Tree protocol

Default:

Disabled

Usage Guide:

To enable **STP** for specific interface

Example:

To enable **STP** for **GigabitEthernet X/X**

```
Switch# configure terminal
```

```
Switch (config)# interface GigabitEthernet X/X
Switch (config-if) # spanning-tree
```

4.2.65.113 spanning-tree auto-edge

Command:

```
spanning-tree auto-edge
```

spanning-tree	Spanning Tree protocol
auto-edge	Auto detects edge status

Default:

Enabled

Usage Guide:

To enable **Auto Edge** of **CIST Normal Port Configuration** for specific interface

Example:

To enable **Auto Edge** of **CIST Normal Port Configuration** for **GigabitEthernet X/X**

```
Switch# configure terminal
Switch (config)# interface GigabitEthernet X/X
Switch (config-if) # spanning-tree auto-edge
```

4.2.65.114 spanning-tree bpdu-guard

Command:

```
spanning-tree bpdu-guard
```

spanning-tree	Spanning Tree protocol
auto-edge	Auto detects edge status

Default:

Disabled

Usage Guide:

To enable **BPDU Guard** of **CIST Normal Port Configuration** for specific interface

Example:

To enable **BPDU Guard** of **CIST Normal Port Configuration** for **GigabitEthernet X/X**

```
Switch# configure terminal
Switch (config)# interface GigabitEthernet X/X
Switch (config-if) # spanning-tree bpduguard
```

4.2.65.115 spanning-tree edge

Command:

```
spanning-tree edge
```

spanning-tree	Spanning Tree protocol
edge	Edge port

Default:

Non-Edge

Usage Guide:

To enable **edge port** of **CIST Normal Port Configuration** for specific interface

Example:

To enable **edge port** of **CIST Normal Port Configuration** for **GigabitEthernet X/X**

```
Switch# configure terminal
Switch (config)# interface GigabitEthernet X/X
Switch (config-if) # spanning-tree edge
```

4.2.65.116 spanning-tree link-type

Command:

```
spanning-tree link-type auto | point-to-point | shared
```

spanning-tree	Spanning Tree protocol
link-type	Port link-type
auto	Auto detect
point-to-point	Forced to point-to-point
shared	Forced to Shared

Default:

Auto

Usage Guide:

To configure **point to point mode** of **CIST Normal Port Configuration** for specific interface

Example:

To enable **point to point mode** (shared) of **CIST Normal Port Configuration** for **GigabitEthernet X/X**

```
Switch# configure terminal
Switch (config)# interface GigabitEthernet X/X
Switch (config-if) # spanning-tree edge
```

4.2.65.117 spanning-tree mst <Instance : 0-7> cost

Command:

```
spanning-tree mst <Instance : 0-7> cost <Cost : 1-200000000> | auto
```

spanning-tree	Spanning Tree protocol
mst	STP bridge instance
<Instance : 0-7>	instance 0-7 (CIST=0, MST2=1...)
cost	STP Cost of this port
<Cost : 1-200000000>	Cost range
auto	Use auto cost

Default:

Auto

Usage Guide:

To configure **Path Cost** of **CIST / MST Normal Port Configuration** for specific interface

Example:

To enable **Path Cost** (100) of **CIST / MST Normal Port Configuration** (CIST) for **GigabitEthernet X/X**

```
Switch# configure terminal
Switch (config)# interface GigabitEthernet X/X
Switch (config-if) # spanning-tree mst 0 cost 100
```

4.2.65.118 spanning-tree mst <Instance : 0-7> cost

Command:

```
spanning-tree mst <Instance : 0-7> port-priority <Prio : 0-240>
```

spanning-tree	Spanning Tree protocol
mst	STP bridge instance
<Instance : 0-7>	instance 0-7 (CIST=0, MST2=1...)

port-priority STP priority of this port
<Prio : 0-240> Range (lower higher priority)
auto Use auto cost

Default:

Auto

Usage Guide:

To configure **Path Cost** of **CIST / MST Normal Port Configuration** for specific interface

Example:

To enable **Path Cost (32)** of **CIST / MST Normal Port Configuration (CIST)** for **GigabitEthernet X/X**

```
Switch# configure terminal
Switch (config)# interface GigabitEthernet X/X
Switch (config-if) # spanning-tree mst 0 port-priority 32
```

4.2.65.119 spanning-tree restricted-role

Command:

```
spanning-tree restricted-role
```

spanning-tree Spanning Tree protocol
restricted-role Port role is restricted (never root port)

Default:

Disabled

Usage Guide:

To enable **Restricted-role** of **CIST Normal Port Configuration** for specific interface

Example:

To enable **Restricted-role** of **CIST Normal Port Configuration** for **GigabitEthernet X/X**

```
Switch# configure terminal
Switch (config)# interface GigabitEthernet X/X
Switch (config-if) # spanning-tree restricted-role
```

4.2.65.120 spanning-tree restricted-tcn

Command:

```
spanning-tree restricted-tcn
```

spanning-tree Spanning Tree protocol
restricted-tcn Restrict topology change notifications

Default:

Disabled

Usage Guide:

To enable **Restrict topology change notifications** of **CIST Normal Port Configuration** for specific interface

Example:

To enable **Restrict topology change notifications** of **CIST Normal Port Configuration** for **GigabitEthernet X/X**

```
Switch# configure terminal
Switch (config)# interface GigabitEthernet X/X
Switch (config-if) # spanning-tree restricted-tcn
```

4.2.65.121 speed

Command:

```
speed [10 | 100 | 1000 | 10g | auto]
```

speed Configures interface speed. If you use 10, 100, or 1000 keywords with the auto keyword the port will only advertise the specified speeds.

10 10Mbps
100 100Mbps
1000 1Gbps
10g 10Gbps
auto Auto negotiation

Default:

Auto

Usage Guide:

To configure line speed for specific interface

Example:

To configure line speed (1Gbps) for **GigabitEthernet X/X**

```
Switch# configure terminal
Switch (config)# interface GigabitEthernet X/X
Switch (config-if) # speed 1000
```

4.2.65.122 switchport access vlan

Command:

```
switchport access vlan <vlan_id>
```

switchport Switching mode characteristics

access Set access mode characteristics of the interface

vlan Set VLAN when interface is in access mode

<vlan_id> VLAN ID of the VLAN when this port is in access mode

Default:

1

Usage Guide:

To configure **access VLAN ID** for specific interface

Example:

To configure **access VLAN ID (5)** for **GigabitEthernet X/X**

```
Switch# configure terminal
Switch (config)# interface GigabitEthernet X/X
Switch (config-if) # switchport access vlan 5
```

4.2.65.123 switchport forbidden vlan add

Command:

```
switchport forbidden vlan add <vlan_list>
```

switchport Switching mode characteristics

forbidden Adds or removes forbidden VLANs from the current list of forbidden VLANs

vlan Add or modify VLAN entry in forbidden table.

add Add to existing list.

<vlan_list> VLAN IDs

Default:

1

Usage Guide:

To add **forbidden VLAN ID** for specific interface

Example:

To add **forbidden VLAN ID (5)** for **GigabitEthernet X/X**

```
Switch# configure terminal
Switch (config)# interface GigabitEthernet X/X
Switch (config-if) # switchport forbidden vlan add 5
```

4.2.65.124 switchport forbidden vlan remove

Command:

```
switchport forbidden vlan remove <vlan_list>
```

switchport Switching mode characteristics

forbidden Adds or removes forbidden VLANs from the current list of forbidden VLANs

vlan Add or modify VLAN entry in forbidden table.

remove Remove from existing list.

<vlan_list> VLAN IDs

Default:

1

Usage Guide:

To remove **forbidden VLAN ID** for specific interface

Example:

To remove **forbidden VLAN ID (5)** for **GigabitEthernet X/X**

```
Switch# configure terminal
Switch (config)# interface GigabitEthernet X/X
Switch (config-if) # switchport forbidden vlan remove 5
```

4.2.65.125 switchport hybrid acceptable-frame-type

Command:

```
switchport hybrid acceptable-frame-type all | tagged | untagged
```

switchport Switching mode characteristics

- hybrid** Change PVID for hybrid port
- acceptable-frame-type** Set acceptable frame type on a port.
- all** Allow all frames
- tagged** Allow only tagged frames
- untagged** Allow only untagged frames

Default:

All

Usage Guide:

To configure **acceptable-frame-type** of **Hybrid VLAN** for specific interface

Example:

To configure **acceptable-frame-type** (tagged) of **Hybrid VLAN** for **GigabitEthernet X/X**

```
Switch# configure terminal
Switch (config)# interface GigabitEthernet X/X
Switch (config-if) # switchport hybrid acceptable-frame-type tagged
```

4.2.65.126 switchport hybrid allowed vlan

Command:

```
switchport hybrid allowed vlan [all | none | add <vlan_list> | remove <vlan_list> | except <vlan_list>]
```

- switchport** Switching mode characteristics
- hybrid** Change PVID for hybrid port
- allowed** Set allowed VLAN characteristics when interface is in hybrid mode
- <vlan_list>** VLAN IDs of the allowed VLANs when this port is in hybrid mode
- add** Add VLANs to the current list
- all** All VLANs
- except** All VLANs except the following
- none** No VLANs
- remove** Remove VLANs from the current list

Default:

All

Usage Guide:

To configure **VLAN list** of **Hybrid VLAN** for specific interface

Example:

To configure **VLAN list (None)** of **Hybrid VLAN** for **GigabitEthernet X/X**

```
Switch# configure terminal
Switch (config)# interface GigabitEthernet X/X
Switch (config-if) # switchport hybrid allowed vlan none
```

4.2.65.127 switchport hybrid egress-tag

Command:

```
switchport hybrid egress-tag [none | all | all except-native]
```

switchport Switching mode characteristics
hybrid Change PVID for hybrid port
egress-tag Egress VLAN tagging configuration
all Tag all frames
none No egress tagging
except-native Tag all frames except frames classified to native VLAN of the hybrid port

Default:

Untagged Port VLAN

Usage Guide:

To configure **Egress Tagging VLAN mode** for specific interface

Example:

To configure **Egress Tagging VLAN mode (None)** for **GigabitEthernet X/X**

```
Switch# configure terminal
Switch (config)# interface GigabitEthernet X/X
Switch (config-if) # switchport hybrid egress-tag none
```

4.2.65.128 switchport hybrid ingress-filtering

Command:

```
switchport hybrid ingress-filtering
```

switchport Switching mode characteristics
hybrid Change PVID for hybrid port
ingress-filtering VLAN Ingress filter configuration

Default:

Enabled

Usage Guide:

To enable **Ingress-filtering** with **Hybrid VLAN mode** for specific interface

Example:

To enable **Ingress-filtering** with **Hybrid VLAN mode** for **GigabitEthernet X/X**

```
Switch# configure terminal
Switch (config)# interface GigabitEthernet X/X
Switch (config-if) # switchport hybrid ingress-filtering
```

4.2.65.129 switchport hybrid native vlan

Command:

```
switchport hybrid native vlan <vlan_id>
```

switchport Switching mode characteristics
hybrid Change PVID for hybrid port
native Set native VLAN
vlan Set native VLAN when interface is in hybrid mode
<vlan_id> VLAN ID of the native VLAN when this port is in hybrid mode

Default:

1

Usage Guide:

To configure **PVID** in **Hybrid VLAN mode** for specific interface

Example:

To enable **PVID (5)** in **Hybrid VLAN mode** for **GigabitEthernet X/X**

```
Switch# configure terminal
Switch (config)# interface GigabitEthernet X/X
Switch (config-if) # switchport hybrid native vlan 5
```

4.2.65.130 switchport hybrid port-type

Command:

```
switchport hybrid port-type c-port | s-custom-port | s-port | unaware
```

switchport Switching mode characteristics
hybrid Change PVID for hybrid port

port-type	Set port type
c-port	Customer port
s-custom-port	Custom Provider port
s-port	Provider port
unaware	Port in not aware of VLAN tags.

Default:

C-port

Usage Guide:

To configure **Port type** in **Hybrid VLAN mode** for specific interface

Example:

To enable **Port type** (Unaware) in **Hybrid VLAN mode** for **GigabitEthernet X/X**

```
Switch# configure terminal
Switch (config)# interface GigabitEthernet X/X
Switch (config-if) # switchport hybrid port-type unaware
```

4.2.65.131 switchport mode

Command:

```
switchport mode c-port | s-custom-port | s-port | unaware
```

switchport	Switching mode characteristics
mode	Set mode of the interface
port-type	Set port type
c-port	Customer port
s-custom-port	Custom Provider port
s-port	Provider port
unaware	Port in not aware of VLAN tags.

Default:

unaware

Usage Guide:

To configure **VLAN mode** for specific interface

Example:

To configure **VLAN mode** (trunk) for **GigabitEthernet X/X**

```
Switch# configure terminal
```

```
Switch (config)# interface GigabitEthernet X/X
Switch (config-if) # switchport mode trunk
```

4.2.65.132 switchport vlan ip-subnet

Command:

```
switchport vlan ip-subnet id <1-128> <ipv4_subnet> vlan <vlan_id>
```

switchport Switching mode characteristics

vlan VLAN commands

ip-subnet VCL IP Subnet-based VLAN configuration.

id id keyword

<1-128> Unique VCE ID for each VCL entry (1-128)

<ipv4_subnet> Source IP address and mask (Format: xx.xx.xx.xx/mm.mm.mm.mm).

vlan vlan keyword

<vlan_id> VLAN ID required for the group to VLAN mapping (Range: 1-4095)

Default:

None

Usage Guide:

To configure **IP Subnet-based VLAN** for specific interface

Example:

To configure **IP Subnet-based VLAN** as below table for **GigabitEthernet X/X**

VCE ID	IP Address	Mask Length	VLAN ID
1	192.168.1.0	24	5

```
Switch# configure terminal
Switch (config)# interface GigabitEthernet X/X
Switch (config-if) # switchport vlan ip-subnet id 1 192.168.1.0/255.255.255.0 vlan 5
```

4.2.65.133 switchport vlan mac

Command:

```
switchport vlan mac <mac_ucast> vlan <vlan_id>
```

switchport Switching mode characteristics

vlan VLAN commands

- mac** MAC-based VLAN commands
- <mac_ucast>** 48 bit unicast MAC address: xx:xx:xx:xx:xx:xx
- vlan** vlan keyword
- <vlan_id>** VLAN ID required for the group to VLAN mapping (Range: 1-4095)

Default:

None

Usage Guide:

To configure **MAC-based VLAN** for specific interface

Example:

To configure **MAC-based VLAN** as below table for **GigabitEthernet X/X**

MAC Address	VLAN ID
00-55-44-33-22-11	5

```
Switch# configure terminal
Switch (config)# interface GigabitEthernet X/X
Switch (config-if) # switchport vlan mac 00:55:44:33:22:11 vlan 5
```

4.2.65.134 switchport vlan mapping

Command:

```
switchport vlan mapping <group id : 1-29>
```

- switchport** Switching mode characteristics
- vlan** VLAN commands
- mapping** Maps an interface to a VLAN translation group.
- <group id : 1-29>** Group id

Default:

None

Usage Guide:

To configure **Group mapping Table** for specific interface

Example:

To configure **Group mapping** (Group 25) for **GigabitEthernet X/X**

```
Switch# configure terminal
Switch (config)# interface GigabitEthernet X/X
Switch (config-if) # switchport vlan mapping 25
```

4.2.65.135 switchport vlan protocol group

Command:

```
switchport vlan protocol group <word16> vlan <vlan_id>
```

switchport Switching mode characteristics

vlan VLAN commands

protocol Protocol-based VLAN commands

group Protocol-based VLAN group commands

<word16> Group Name (Range: 1 - 16 characters)

vlan vlan keyword

<vlan_id> VLAN ID required for the group to VLAN mapping (Range: 1-4095)

Default:

None

Usage Guide:

To configure **VLAN protocol group** for specific interface

Example:

To configure **VLAN protocol group** as tabled below for **GigabitEthernet X/X**

Group Name	VLAN ID
8081	5

```
Switch# configure terminal
Switch (config)# interface GigabitEthernet X/X
Switch (config-if) # switchport vlan protocol group 8081 vlan 5
```

4.2.65.136 switchport voice vlan discovery-protocol

Command:

```
switchport voice vlan discovery-protocol both | lldp | oui
```

switchport Switching mode characteristics

voice Voice appliance attributes

vlan Vlan for voice traffic

discovery-protocol Set Voice VLAN port discovery protocol

both Detect telephony device by OUI address and LLDP

lldp Detect telephony device by LLDP

oui Detect telephony device by OUI address

Default:

OUI

Usage Guide:

To configure **Discovery-protocol** in the **Voice VLAN** for specific interface

Example: To configure **Discovery-protocol** (LLDP) in the **Voice VLAN** for **GigabitEthernet X/X**

```
Switch# configure terminal
Switch (config)# interface GigabitEthernet X/X
Switch (config-if) # switchport voice vlan discovery-protocol lldp
```

4.2.65.137 switchport voice vlan mode

Command:

```
switchport voice vlan mode auto | disable | force
```

switchport Switching mode characteristics

voice Voice appliance attributes

vlan Vlan for voice traffic

mode Set Voice VLAN port mode

auto Enable auto detect mode

disable disjoin Voice VLAN

force Force to join Voice VLAN

Default:

Disabled

Usage Guide:

To configure **Voice VLAN mode** for specific interface

Example:

To configure **Voice VLAN mode** (Auto) for **GigabitEthernet X/X**

```
Switch# configure terminal
Switch (config)# interface GigabitEthernet X/X
Switch (config-if) # switchport voice vlan mode auto
```

4.2.65.138 switchport voice vlan security

Command:

```
switchport voice vlan security
```

switchport Switching mode characteristics
voice Voice appliance attributes
vlan Vlan for voice traffic
security Enable Voice VLAN port security mode

Default:

Disabled

Usage Guide:

To enable **Voice VLAN security** for specific interface

Example:

To enable **Voice VLAN security** for **GigabitEthernet X/X**

```
Switch# configure terminal
Switch (config)# interface GigabitEthernet X/X
Switch (config-if) # switchport voice vlan security
```

4.2.66 interface vlan

Command:

```
interface vlan <vlan_list>
```

vlan VLAN interface configurations
<vlan_list> List of VLAN interface numbers, 1~4095

Default:

N/A

Usage Guide:

To enter the **VLAN interface mode**.

Example:

To enter the **VLAN 1 interface mode**

```
Switch# configure terminal
Switch (config)# interface vlan 1
Switch (config-if-vlan)#
```

4.2.66.1 do

Command:

```
do < exec commands >
```

do To run exec commands in config mode

Default:

N/A

Usage Guide:

To run **exec commands** in **configure terminal mode**

Example:

To run "show aaa" in **configure terminal mode**.

```
Switch# configure terminal
Switch (config)# interface vlan X
Switch (config-if-vlan)# do show aaa
console : local
telnet : local
ssh : local
http : local
```

4.2.66.2 end

Command:

```
end
```

end Go back to EXEC mode

Default:

Auto

Usage Guide:

To back to **EXEC mode**

Example:

To back to **EXEC mode**

```
Switch# configure terminal
Switch (config)# interface vlan X
Switch (config-if-vlan)# end
Switch#
```

4.2.66.3 exit

Command:

```
exit
```

exit Exit from current mode

Default:

None

Usage Guide:

To exit current mode

Example:

To exit current mode.

```
Switch# configure terminal
Switch (config)# interface vlan X
Switch (config-if-vlan)# exit
Switch (config)#
```

4.2.66.4 ip address

Command:

```
ip address <ipv4_addr> <ipv4_netmask>
```

ip Interface Internet Protocol config commands

address Address configuraton

<ipv4_addr> IP address

<ipv4_netmask> IP netmask

Default:

None

Usage Guide:

To configure **IP address mode** for specific VLAN

Example:

To configure **IP address mode** (192.168.1.10/24) for **VLAN X**

```
Switch# configure terminal
Switch (config)# interface vlan X
Switch (config-if-vlan)# ip address 192.168.1.10 255.255.255.0
```

4.2.66.5 ip address dhcp

Command:

```
ip address dhcp
```

ip Interface Internet Protocol config commands

address Address configuraton

dhcp Enable DHCP

Default:

None

Usage Guide:

To configure **IP address mode** for specific VLAN

Example:

To configure **IP address mode** (DHCP) for **VLAN X**

```
Switch# configure terminal
Switch (config)# interface vlan X
Switch (config-if-vlan)# ip address dhcp
```

4.2.66.6 ip address dhcp fallback

Command:

```
ip address dhcp fallback <ipv4_addr> <ipv4_netmask>
```

ip Interface Internet Protocol config commands

address Address configuraton

dhcp Enable DHCP

<ipv4_addr> DHCP fallback address

<ipv4_netmask> DHCP fallback netmask

Default:

None

Usage Guide:

To configure **DHCP fallback IP address** for specific VLAN

Example:

To configure **DHCP fallback IP address** (192.168.1.10/24) for **VLAN X**

```
Switch# configure terminal
Switch (config)# interface vlan X
Switch (config-if-vlan)# ip address dhcp fallback 192.168.1.10 255.255.255.0
```

4.2.66.7 ip dhcp server

Command:

```
ip dhcp server
```

- ip** Interface Internet Protocol config commands
- dhcp** Configure DHCP server parameters
- server** Enable DHCP server per VLAN

Default:

None

Usage Guide:

To enable **IPv4 DHCP Server** for specific VLAN

Example:

To enable **IPv4 DHCP Server** for **VLAN X**

```
Switch# configure terminal
Switch (config)# interface vlan X
Switch (config-if-vlan)# ip dhcp server
```

4.2.66.8 ip igmp snooping

Command:

```
ip igmp snooping
```

- ip** Interface Internet Protocol config commands
- igmp** Internet Group Management Protocol
- snooping** Snooping IGMP

Default:

Disabled

Usage Guide:

To enable **IGMP snooping** for specific VLAN

Example:

To enable **IGMP snooping** for **VLAN X**

```
Switch# configure terminal
Switch (config)# interface vlan X
Switch (config-if-vlan)# ip igmp snooping
```

4.2.66.9 ip igmp snooping compatibility

Command:

```
ip igmp snooping compatibility auto | v1 | v2 | v3
```

ip Interface Internet Protocol config commands
igmp Internet Group Management Protocol
snooping Snooping IGMP
compatibility Interface compatibility
auto Compatible with IGMPv1/IGMPv2/IGMPv3
v1 Forced IGMPv1
v2 Forced IGMPv2
v3 Forced IGMPv3

Default:

Auto

Usage Guide:

To configure **IGMP snooping version** for specific VLAN

Example:

To configure **IGMP snooping V2** for **VLAN X**

```
Switch# configure terminal
Switch (config)# interface vlan X
Switch (config-if-vlan)# ip igmp snooping compatibility v2
```

4.2.66.10 ip igmp snooping last-member-query-interval

Command:

```
ip igmp snooping last-member-query-interval <lpmcLmqi : 0-31744>
```

ip Interface Internet Protocol config commands
igmp Internet Group Management Protocol
snooping Snooping IGMP
last-member-query-interval Last Member Query Interval in tenths of seconds

<IpmcLmqi : 0-31744> 0 - 31744 tenths of seconds

Default:

10

Usage Guide:

To configure **Last-member-query-interval of IGMP snooping** for specific VLAN

Example:

To configure **Last-member-query-interval (100 seconds) of IGMP snooping for VLAN X**

```
Switch# configure terminal
Switch (config)# interface vlan X
Switch (config-if-vlan)# ip igmp snooping last-member-query-interval 1000
```

4.2.66.11 ip igmp snooping priority

Command:

```
ip igmp snooping priority <CosPriority : 0-7>
```

ip Interface Internet Protocol config commands

igmp Internet Group Management Protocol

snooping Snooping IGMP

priority Interface CoS priority

<CosPriority : 0-7> CoS priority ranges from 0 to 7

Default:

0

Usage Guide:

To configure **CoS priority of IGMP snooping** for specific VLAN

Example:

To configure **CoS priority (5) of IGMP snooping for VLAN X**

```
Switch# configure terminal
Switch (config)# interface vlan X
Switch (config-if-vlan)# ip igmp snooping priority 5
```

4.2.66.12 ip igmp snooping querier address

Command:

```
ip igmp snooping querier address <ipv4_ucast>
```

ip Interface Internet Protocol config commands
igmp Internet Group Management Protocol
snooping Snooping IGMP
querier IGMP Querier configuration
address IGMP Querier address configuration
<ipv4_ucast> A valid IPv4 unicast address

Default:

0.0.0.0

Usage Guide:

To configure **Querier address of IGMP snooping** for specific VLAN

Example:

To configure **Querier address (192.168.1.15) of IGMP snooping** for **VLAN X**

```
Switch# configure terminal
Switch (config)# interface vlan X
Switch (config-if-vlan)# ip igmp snooping querier address 192.168.1.15
```

4.2.66.13 ip igmp snooping querier election

Command:

```
ip igmp snooping querier election
```

ip Interface Internet Protocol config commands
igmp Internet Group Management Protocol
snooping Snooping IGMP
querier IGMP Querier configuration
election Act as an IGMP Querier to join Querier-Election

Default:

Enabled

Usage Guide:

To enable **Querier-election of IGMP snooping** for specific VLAN

Example:

To enable **Querier-election of IGMP snooping** for **VLAN X**

```
Switch# configure terminal
Switch (config)# interface vlan X
Switch (config-if-vlan)# ip igmp snooping querier election
```

4.2.66.14 ip igmp snooping query-interval

Command:

```
ip igmp snooping query-interval <lpmcQi : 1-31744>
```

ip Interface Internet Protocol config commands
igmp Internet Group Management Protocol
snooping Snooping IGMP
query-interval Query Interval in seconds
<lpmcQi : 1-31744> 1 - 31744 seconds

Default:

125

Usage Guide:

To configure **Querier-interval of IGMP snooping** for specific VLAN

Example:

To configure **Querier-interval (600 seconds) of IGMP snooping** for **VLAN X**

```
Switch# configure terminal
Switch (config)# interface vlan X
Switch (config-if-vlan)# ip igmp snooping query-interval 600
```

4.2.66.15 ip igmp snooping query-max-response-time

Command:

```
ip igmp snooping query-max-response-time <lpmcQi : 1-31744>
```

ip Interface Internet Protocol config commands
igmp Internet Group Management Protocol
snooping Snooping IGMP
query-max-response-time Query Response Interval in tenths of seconds
<lpmcQri : 0-31744> 0 - 31744 tenths of seconds

Default:

125

Usage Guide:

To configure **Querier-interval of IGMP snooping** for specific VLAN

Example:

To configure **Querier-interval (60 seconds) of IGMP snooping** for **VLAN X**

```
Switch# configure terminal
Switch (config)# interface vlan X
Switch (config-if-vlan)# ip igmp snooping query-max-response-time 600
```

4.2.66.16 ip igmp snooping robustness-variable

Command:

```
ip igmp snooping robustness-variable <lpmcRv : 1-255>
```

- ip** Interface Internet Protocol config commands
- igmp** Internet Group Management Protocol
- snooping** Snooping IGMP
- robustness-variable** Robustness Variable
- <lpmcRv : 1-255>** Packet loss tolerance count from 1 to 255

Default:

2

Usage Guide:

To configure **Robustness Variable of IGMP snooping** for specific VLAN

Example:

To configure **Robustness Variable (88) of IGMP snooping** for **VLAN X**

```
Switch# configure terminal
Switch (config)# interface vlan X
Switch (config-if-vlan)# ip igmp snooping robustness-variable 88
```

4.2.66.17 ip igmp snooping unsolicited-report-interval

Command:

```
ip igmp snooping unsolicited-report-interval <lpmcUri : 0-31744>
```

ip Interface Internet Protocol config commands

igmp Internet Group Management Protocol

snooping Snooping IGMP

robustness-variable Robustness Variable

<lpmcUri : 0-31744> 0 - 31744 seconds

Default:

1

Usage Guide:

To configure **Unsolicited-Report-Interval of IGMP snooping** for specific VLAN

Example:

To configure **Unsolicited-Report-Interval (99 seconds) of IGMP snooping** for **VLAN X**

```
Switch# configure terminal
Switch (config)# interface vlan X
Switch (config-if-vlan)# ip igmp snooping unsolicited-report-interval 99
```

4.2.66.18 ipv6 address

Command:

```
ipv6 address X:X:X:X::X/<0-128>
```

ipv6 IPv6 configuration commands

address Configure the IPv6 address of an interface

X:X:X:X::X/<0-128> IPv6 prefix x:x::y/z

Default:

None

Usage Guide:

To configure **IPv6 address** for specific VLAN

Example:

To configure **IPv6 address (2001::7788/64)** for **VLAN X**

```
Switch# configure terminal
Switch (config)# interface vlan X
```

```
Switch (config-if-vlan)# ipv6 address 2001::7788/64
```

4.2.66.19 ipv6 mld snooping

Command:

```
ipv6 mld snooping
```

ipv6 IPv6 configuration commands
mld Multicast Listener Discovery
snooping Snooping MLD

Default:

Disabled

Usage Guide:

To enable **MLD snooping** for specific VLAN

Example:

To enable **MLD snooping** for **VLAN X**

```
Switch# configure terminal
Switch (config)# interface vlan X
Switch (config-if-vlan)# ipv6 mld snooping
```

4.2.66.20 ipv6 mld snooping compatibility

Command:

```
ipv6 mld snooping compatibility auto | v1 | v2
```

ipv6 IPv6 configuration commands
mld Multicast Listener Discovery
snooping Snooping MLD
compatibility Interface compatibility
auto Compatible with MLDv1/MLDv2
v1 Forced MLDv1
v2 Forced MLDv2

Default:

Auto

Usage Guide:

To configure **MLD snooping version** for specific VLAN

Example:

To configure **MLD snooping V2** for **VLAN X**

```
Switch# configure terminal
Switch (config)# interface vlan X
Switch (config-if-vlan)# ipv6 mld snooping compatibility v2
```

4.2.66.21 ipv6 mld snooping last-member-query-interval

Command:

```
ipv6 mld snooping last-member-query-interval <lpmcLmqi : 0-31744>
```

ipv6 IPv6 configuration commands
mld Multicast Listener Discovery
snooping Snooping MLD
last-member-query-interval Last Member Query Interval in tenths of seconds
<lpmcLmqi : 0-31744> 0 - 31744 tenths of seconds

Default:

10

Usage Guide:

To configure **Last-member-query-interval of MLD snooping** for specific VLAN

Example:

To configure **Last-member-query-interval (100 seconds) of MLD snooping** for **VLAN X**

```
Switch# configure terminal
Switch (config)# interface vlan X
Switch (config-if-vlan)# ipv6 mld snooping last-member-query-interval 1000
```

4.2.66.22 ipv6 mld snooping priority

Command:

```
ipv6 mld snooping priority <CosPriority : 0-7>
```

ipv6 IPv6 configuration commands
mld Multicast Listener Discovery
snooping Snooping MLD
priority Interface CoS priority
<CosPriority : 0-7> CoS priority ranges from 0 to 7

Default:

0

Usage Guide:

To configure **CoS priority of MLD snooping** for specific VLAN

Example:

To configure **CoS priority (5) of MLD snooping** for **VLAN X**

```
Switch# configure terminal
Switch (config)# interface vlan X
Switch (config-if-vlan)# ipv6 mld snooping priority 5
```

4.2.66.23 ipv6 mld snooping querier election

Command:

```
ipv6 mld snooping querier election
```

- ipv6** IPv6 configuration commands
- mld** Multicast Listener Discovery
- snooping** Snooping MLD
- querier** MLD Querier configuration
- election** Act as an MLD Querier to join Querier-Election

Default:

Enabled

Usage Guide:

To enable **Querier-election of MLD snooping** for specific VLAN

Example:

To enable **Querier-election of MLD snooping** for **VLAN X**

```
Switch# configure terminal
Switch (config)# interface vlan X
Switch (config-if-vlan)# ipv6 mld snooping querier election
```

4.2.66.24 ipv6 mld snooping query-interval

Command:

```
ipv6 mld snooping query-interval <lpmcQi : 1-31744>
```

ipv6 IPv6 configuration commands
mld Multicast Listener Discovery
snooping Snooping MLD
query-interval Query Interval in seconds
<lpmcQi : 1-31744> 1 - 31744 seconds

Default:

125

Usage Guide:

To configure **Querier-interval of MLD snooping** for specific VLAN

Example:

To configure **Querier-interval (600 seconds) of MLD snooping** for **VLAN X**

```
Switch# configure terminal
Switch (config)# interface vlan X
Switch (config-if-vlan)# ipv6 mld snooping query-interval 600
```

4.2.66.25 ipv6 mld snooping query-max-response-time

Command:

```
ipv6 mld snooping query-max-response-time <lpmcQri : 1-31744>
```

ipv6 IPv6 configuration commands
mld Multicast Listener Discovery
snooping Snooping MLD
query-max-response-time Query Response Interval in tenths of seconds
<lpmcQri : 0-31744> 0 - 31744 tenths of seconds

Default:

125

Usage Guide:

To configure **Querier-interval of MLD snooping** for specific VLAN

Example:

To configure **Querier-interval (60 seconds) of MLD snooping** for **VLAN X**

```
Switch# configure terminal
Switch (config)# interface vlan X
Switch (config-if-vlan)# ipv6 mld snooping query-max-response-time 600
```

4.2.66.26 ipv6 mld snooping robustness-variable

Command:

```
ipv6 mld snooping robustness-variable <lpmcRv : 1-255>
```

ipv6 IPv6 configuration commands
mld Multicast Listener Discovery
snooping Snooping MLD
robustness-variable Robustness Variable
<lpmcRv : 1-255> Packet loss tolerance count from 1 to 255

Default:

2

Usage Guide:

To configure **Robustness Variable of MLD snooping** for specific VLAN

Example:

To configure **Robustness Variable (88) of MLD snooping** for **VLAN X**

```
Switch# configure terminal
Switch (config)# interface vlan X
Switch (config-if-vlan)# ipv6 mld snooping robustness-variable 88
```

4.2.66.27 ipv6 mld snooping unsolicited-report-interval

Command:

```
ipv6 mld snooping unsolicited-report-interval <lpmcUri : 0-31744>
```

ipv6 IPv6 configuration commands
mld Multicast Listener Discovery
snooping Snooping MLD
robustness-variable Robustness Variable
<lpmcUri : 0-31744> 0 - 31744 seconds

Default:

1

Usage Guide:

To configure **Unsolicited-Report-Interval of MLD snooping** for specific VLAN

Example:

To configure **Unsolicited-Report-Interval (99 seconds) of MLD snooping** for **VLAN X**

```
Switch# configure terminal
Switch (config)# interface vlan X
Switch (config-if-vlan)# ipv6 mld snooping unsolicited-report-interval 99
```

4.2.66.28 no

Command:

```
no
```

no Negate a command or set its defaults

Default:

N/A

Usage Guide:

To default the function for specific interface

Example:

To disable the function (**ip address dhcp**) for **VLAN X**

```
Switch# configure terminal
Switch (config)# interface vlan X
Switch (config-if-vlan)# no ip address dhcp
```

4.2.67 ip arp inspection

Command:

```
ip arp inspection
```

- ip** Internet Protocol
- arp** Address Resolution Protocol
- inspection** ARP inspection

Default:

N/A

Usage Guide:

To enable **ARP inspection**

Example:

To enable **ARP inspection**

```
Switch# configure terminal
Switch (config)# ip arp inspection
```

4.2.68 ip arp inspection entry interface

Command:

```
ip arp inspection entry interface [10GigabitEthernet | GigabitEthernet] <vlan_id>
<mac_ucast> <ipv4_ucast>
```

ip Internet Protocol

arp Address Resolution Protocol

inspection ARP inspection

entry arp inspection entry

interface arp inspection entry interface config

GigabitEthernet 1 Gigabit Ethernet Port

10GigabitEthernet 10 Gigabit Ethernet Port

<vlan_id> Select a VLAN id to configure

<mac_ucast> Select a MAC address to configure

<ipv4_ucast> Select an IP Address to configure

Default:

N/A

Usage Guide:

To configure **Static ARP Inspection Table**.

Example:

To configure **Static ARP Inspection Table** as below table.

Port	VLAN ID	MAC Address	IP Address
1	1	00-11-22-33-44-55	192.168.0.18

```
Switch# configure terminal
Switch (config)# ip arp inspection entry interface GigabitEthernet 1/1 1
00:11:22:33:44:55 192.168.0.18
```

4.2.69 ip arp inspection translate

Command:

ip arp inspection translate

ip Internet Protocol
arp Address Resolution Protocol
inspection ARP inspection
translate arp inspection translate all entries

Default:

N/A

Usage Guide:

To translate dynamic entries into **static ARP inspection table**.

Example:

To translate dynamic entries into **static ARP inspection table**.

```
Switch# configure terminal
Switch (config)# ip arp inspection translate
ARP Inspection:
    Translate 1 dynamic entries into static entries.
```

4.2.70 ip arp inspection translate interface

Command:

```
ip arp inspection translate interface [10GigabitEthernet | GigabitEthernet] <vlan_id>
<mac_ucast> <ipv4_ucast>
```

ip Internet Protocol
arp Address Resolution Protocol
inspection ARP inspection
translate arp inspection translate all entries
interface arp inspection entry interface config
GigabitEthernet 1 Gigabit Ethernet Port
10GigabitEthernet 10 Gigabit Ethernet Port
<vlan_id> Select a VLAN id to configure
<mac_ucast> Select a MAC address to configure
<ipv4_ucast> Select an IP Address to configure

Default:

N/A

Usage Guide:

To translate dynamic entries into **static ARP inspection table** for specific interface.

Example:

To translate below dynamic entries into **static ARP inspection table** for **GigabitEthernet 1/1**.

Port	VLAN ID	MAC Address	IP Address
1	1	00-11-22-33-44-55	192.168.0.18

```
Switch# configure terminal
Switch (config)# ip arp inspection translate interface GigabitEthernet 1/1 1
00:11:22:33:44:55 192.168.0.18
```

4.2.71 ip arp inspection vlan

Command:

```
ip arp inspection vlan <vlan_list> logging all | deny | permit
```

ip Internet Protocol

arp Address Resolution Protocol

inspection ARP inspection

vlan arp inspection vlan setting

<vlan_list> arp inspection vlan list

logging ARP inspection vlan logging mode config

all log all entries

deny log denied entries

permit log permitted entries

Default:

N/A

Usage Guide:

To configure **VLAN mode** of **ARP inspection**.

Example:

To configure **VLAN mode** (VLAN 1, Log type: Permit) of **ARP inspection**.

```
Switch# configure terminal
Switch (config)# ip arp inspection vlan 1 logging permit
```

4.2.72 ip dhcp excluded-address

Command:

```
ip dhcp excluded-address <A.B.C.D>
```

ip Internet Protocol

dhcp Dynamic Host Configuration Protocol
excluded-address Prevent DHCP from assigning certain addresses
<A.B.C.D> Low IP address

Default:

N/A

Usage Guide:

To configure **excluded IP range** of **DHCP Server**.

Example:

To configure **excluded IP range** (192.168.0.100~192.168.0.101) of **DHCP Server**.

```
Switch# configure terminal
Switch (config)# ip dhcp excluded-address 192.168.0.100 192.168.0.101
```

4.2.73 ip dhcp pool

Command:

```
ip dhcp pool <WORD>
```

ip Internet Protocol
dhcp Dynamic Host Configuration Protocol
pool Configure DHCP address pools
<WORD> Pool name in 32 characters

Default:

N/A

Usage Guide:

To create a **DHCP pool**.

Example:

To create a **DHCP pool (Name: planetbestswitch)**.

```
Switch# configure terminal
Switch (config)# ip dhcp pool planetbestswitch
Switch (config-dhcp-pool)#
```

4.2.73.1 broadcast

Command:

```
broadcast <A.B.C.D>
```

broadcast Broadcast address in use on the client's subnet

<A.B.C.D> Broadcast IP address

Default:

None

Usage Guide:

To configure **Broadcast IP address (DHCP option 28)** of **DHCP Server**

Example:

To configure **Broadcast IP address (192.168.0.66)** of **DHCP Server** for **pool "planetbestswitch"**

```
Switch# configure terminal
Switch (config)# ip dhcp pool planetbestswitch
Switch (config-dhcp-pool)# broadcast 192.168.0.66
```

4.2.73.2 client-identifier fqdn

Command:

```
client-identifier fqdn <LINE>
```

client-identifier Client identifier

fqdn FQDN type of client identifier

<LINE> FQDN in 128 characters

Default:

None

Usage Guide:

To configure **FQDN** of **DHCP Server**

Example:

To configure **FQDN (123)** of **DHCP Server** for **pool "planetbestswitch"**

```
Switch# configure terminal
Switch (config)# ip dhcp pool planetbestswitch
Switch (config-dhcp-pool)# client-identifier fqdn 123
```

4.2.73.3 client-identifier mac-address

Command:

```
client-identifier mac-address <MAC>
```

client-identifier Client identifier

mac-address MAC address type of client identifier

<MAC> MAC address of client

Default:

None

Usage Guide:

To configure **Bind IP to MAC** of **DHCP Server**

Example:

To configure **Bind IP to MAC** (00:11:22:33:44:55) of **DHCP Server** for **pool** "planetbestswitch"

```
Switch# configure terminal
Switch (config)# ip dhcp pool planetbestswitch
Switch (config-dhcp-pool)# client-identifier mac-address 00:11:22:33:44:55
```

4.2.73.4 client-name

Command:

```
client-name
```

client-name Client host name

Default:

None

Usage Guide:

To configure **Client-name** of **DHCP Server**

Example:

To configure **Client-name** (555) of **DHCP Server** for **pool** "planetbestswitch"

```
Switch# configure terminal
Switch (config)# ip dhcp pool planetbestswitch
Switch (config-dhcp-pool)# client-name 555
```

4.2.73.5 default-router

Command:

```
default-router <A.B.C.D>
```

default-router Default routers

<A.B.C.D> Router's IP address

Default:

None

Usage Guide:

To configure **Default Gateway** of **DHCP Server**

Example:

To configure **Default Gateway** (192.168.0.1) of **DHCP Server** for **pool** "planetbestswitch"

```
Switch# configure terminal
Switch (config)# ip dhcp pool planetbestswitch
Switch (config-dhcp-pool)# default-router 192.168.0.1
```

4.2.73.6 dns-server

Command:

```
dns-server <A.B.C.D>
```

dns-server DNS servers

<A.B.C.D> Server's IP address

Default:

None

Usage Guide:

To configure **DNS Server** of **DHCP Server**

Example:

To configure **DNS Server** (168.95.1.1, 8.8.8.8) of **DHCP Server** for **pool** "planetbestswitch"

```
Switch# configure terminal
Switch (config)# ip dhcp pool planetbestswitch
Switch (config-dhcp-pool)# dns-server 168.95.1.1 8.8.8.8
```

4.2.73.7 do

Command:

```
do < exec commands >
```

do To run exec commands in config mode

Default:

N/A

Usage Guide:

To run **exec commands**

Example:

To run "show aaa".

```
Switch# configure terminal
Switch (config)# ip dhcp pool planetbestswitch
Switch (config-dhcp-pool)# do show aaa

console : local
telnet  : local
ssh    : local
http   : local
```

4.2.73.8 domain-name

Command:

```
domain-name <word128>
```

domain-name Domain name

<word128> Domain name

Default:

None

Usage Guide:

To configure **Domain Name** of **DHCP Server**

Example:

To configure **Domain Name** (planet.com) of **DHCP Server** for **pool** "planetbestswitch"

```
Switch# configure terminal
Switch (config)# ip dhcp pool planetbestswitch
Switch (config-dhcp-pool)# domain-name planet.com
```

4.2.73.9 end

Command:

```
end
```

end Go back to EXEC mode

Default:

Auto

Usage Guide:

To back to **EXEC mode**

Example:

To back to **EXEC mode**

```
Switch# configure terminal
Switch (config)# ip dhcp pool planetbestswitch
Switch (config-dhcp-pool)# end
Switch#
```

4.2.73.10 exit

Command:

```
exit
```

exit Exit from current mode

Default:

None

Usage Guide:

To exit current mode

Example:

To exit current mode.

```
Switch# configure terminal
Switch (config)# ip dhcp pool planetbestswitch
Switch (config-dhcp-pool)# exit
Switch (config)#
```

4.2.73.11 hardware-address

Command:

```
hardware-address <MAC>
```

hardware-address Client hardware address

<MAC> Client MAC address

Default:

None

Usage Guide:

To configure **MAC address** of **DHCP Server** while the pool is in the **host** type.

Example:

To configure **MAC address** (00:11:22:33:44:55) of **DHCP Server** for **pool** “planetbestswitch” while the pool is in the **host** type.

```
Switch# configure terminal
Switch (config)# ip dhcp pool planetbestswitch
Switch (config-dhcp-pool)# hardware-address 00:11:22:33:44:55
```

4.2.73.12 host

Command:

```
host <IP: A.B.C.D> <Subnet: A.B.C.D>
```

host Client IP address and mask

<IP: A.B.C.D> Network number

<Subnet: A.B.C.D> Network mask in dotted-decimal notation, excluding 255.255.255.255

Default:

None

Usage Guide:

To configure **Host IP address** of **DHCP Server**.

Example:

To configure **Host IP address** (192.168.1.10/24) of **DHCP Server** for **pool** “planetbestswitch”.

```
Switch# configure terminal
Switch (config)# ip dhcp pool planetbestswitch
Switch (config-dhcp-pool)# host 192.168.1.10 255.255.255.0
```

4.2.73.13 lease

Command:

```
lease <0-365> <0-23> <0-59> | infinite
```

lease Address lease time
<0-365> Days
<0-23> Hours
<0-59> Minutes
infinite Infinite lease

Default:

1 day

Usage Guide:

To configure **Lease Time** of **DHCP Server**.

Example:

To configure **Lease Time** (119 minutes) of **DHCP Server** for **pool** "planetbestswitch".

```
Switch# configure terminal
Switch (config)# ip dhcp pool planetbestswitch
Switch (config-dhcp-pool)# lease 0 1 59
```

4.2.73.14 netbios-name-server

Command:

```
netbios-name-server <A.B.C.D>
```

netbios-name-server NetBIOS (WINS) name servers
<A.B.C.D> Server's IP address

Default:

None

Usage Guide:

To configure **NetBIOS Name Server** of **DHCP Server**.

Example:

To configure **NetBIOS Name Server** (192.168.1.10) of **DHCP Server** for **pool** "planetbestswitch".

```
Switch# configure terminal
Switch (config)# ip dhcp pool planetbestswitch
Switch (config-dhcp-pool)# netbios-name-server 192.168.1.10
```

4.2.73.15 netbios-node-type

Command:

```
netbios-node-type b-node | h-node | m-node | p-node
```

netbios-node-type NetBIOS node type

b-node Broadcast node

h-node Hybrid node

m-node Mixed node

p-node Peer-to-peer node

Default:

None

Usage Guide:

To configure **NetBIOS node type** of **DHCP Server**.

Example:

To configure **NetBIOS node type** (B-node) of **DHCP Server** for **pool** “planetbestswitch”.

```
Switch# configure terminal
Switch (config)# ip dhcp pool planetbestswitch
Switch (config-dhcp-pool)# netbios-node-type b-node
```

4.2.73.16 netbios-scope

Command:

```
netbios-scope <LINE>
```

netbios-scope NetBIOS scope

<LINE> Netbios scope identifier, in 128 characters

Default:

None

Usage Guide:

To configure **NetBIOS scope** of **DHCP Server**.

Example:

To configure **NetBIOS scope** (planet) of **DHCP Server** for **pool** “planetbestswitch”.

```
Switch# configure terminal
Switch (config)# ip dhcp pool planetbestswitch
Switch (config-dhcp-pool)# netbios-scope planet
```

4.2.73.17 network

Command:

```
network <IP: A.B.C.D> <Subnet: A.B.C.D>
```

network Network number and mask

<IP: A.B.C.D> Network number

<Subnet: A.B.C.D> Network mask in dotted-decimal notation, excluding 255.255.255.255

Default:

None

Usage Guide:

To configure **Network IP address of DHCP Server**.

Example:

To configure **Network IP address** (192.168.1.11/24) of **DHCP Server** for **pool** “planetbestswitch”.

```
Switch# configure terminal
Switch (config)# ip dhcp pool planetbestswitch
Switch (config-dhcp-pool)# network 192.168.0.11 255.255.255.0
```

4.2.73.18 nis-domain-name

Command:

```
nis-domain-name <word128>
```

nis-domain-name NIS domain name

<word128> Domain name

Default:

None

Usage Guide:

To configure **NIS Domain Name of DHCP Server**

Example:

To configure **NIS Domain Name** (planet.com) of **DHCP Server** for **pool** “planetbestswitch”

```
Switch# configure terminal
Switch (config)# ip dhcp pool planetbestswitch
Switch (config-dhcp-pool)# nis-domain-name planet.com
```

4.2.73.19 nis-server

Command:

```
nis-server <A.B.C.D>
```

nis-server Network information servers

<A.B.C.D> Server's IP address

Default:

None

Usage Guide:

To configure **NIS Server** of **DHCP Server**

Example:

To configure **NIS Server** (1.1.1.1) of **DHCP Server** for pool "planetbestswitch"

```
Switch# configure terminal
Switch (config)# ip dhcp pool planetbestswitch
Switch (config-dhcp-pool)# nis-server 1.1.1.1
```

4.2.73.20 no

Command:

```
no
```

no Negate a command or set its defaults

Default:

N/A

Usage Guide:

To default the function

Example:

To disable the function (**nis-domain-name planet.com**) for pool "planetbestswitch"

```
Switch# configure terminal
Switch (config)# ip dhcp pool planetbestswitch
Switch (config-dhcp-pool)# no nis-domain-name planet.com
```

4.2.73.21 ntp-server

Command:

```
ntp-server <A.B.C.D>
```

ntp-server NTP servers

<A.B.C.D> Server's IP address

Default:

None

Usage Guide:

To configure **NTP Server** of **DHCP Server**

Example:

To configure **NTP Server** (1.1.1.1) of **DHCP Server** for **pool** "planetbestswitch"

```
Switch# configure terminal
Switch (config)# ip dhcp pool planetbestswitch
Switch (config-dhcp-pool)# ntp-server 1.1.1.1
```

4.2.73.22 vendor

Command:

```
vendor class-identifier "<0x "> specific-info <HEX-VALUE>
```

vendor Vendor configuration

class-identifier Vendor class identifier

"<0x "> Class identifier in 64 characters

specific-info Vendor specific information

<HEX-VALUE> Hex values in 64 octets

Default:

None

Usage Guide:

To configure **Vendor ID** and **info** of **DHCP Server**

Example:

To configure **Vendor ID** and **info** as below table of **DHCP Server** for **pool** "planetbestswitch"

Vendor 1 Class Identifier	0x8
Vendor 1 Specific Information	0x08

```
Switch# configure terminal
Switch (config)# ip dhcp pool planetbestswitch
Switch (config-dhcp-pool)# vendor class-identifier "0x8" specific-info 0x8
```

4.2.74 ip dns proxy

Command:

```
ip dns proxy
```

ip Internet Protocol
dns Domain Name System
proxy DNS proxy service

Default:

Disabled

Usage Guide:

To enable **DNS proxy**.

Example:

To enable **DNS proxy**.

```
Switch# configure terminal
Switch (config)# ip dns proxy
```

4.2.75 ip helper-address

Command:

```
ip helper-address <ip : ipv4_ucast>
```

ip Internet Protocol
helper-address DHCP relay server
<ip : ipv4_ucast> IP address of the DHCP relay server

Default:

None

Usage Guide:

To configure **IP address** of **DHCP**.

Example:

To configure **IP address** (1.1.1.1) of **DHCP**.

```
Switch# configure terminal
Switch (config)# ip helper-address 1.1.1.1
```

4.2.76 ip http secure-redirect

Command:

```
ip http secure-redirect
```

ip Internet Protocol
http Hypertext Transfer Protocol
secure-redirect Secure HTTP web redirection

Default:

Disabled

Usage Guide:

To redirect **WebUI** from **HTTP** to **HTTPS**

Example:

To redirect **WebUI** from **HTTP** to **HTTPS**

```
Switch# configure terminal
Switch (config)# ip http secure-redirect
```

4.2.77 ip http secure-server

Command:

```
ip http secure-server
```

ip Internet Protocol
http Hypertext Transfer Protocol
secure-server Secure HTTP web server

Default:

Disabled

Usage Guide:

To enable **HTTPS WebUI**.

Example:

To enable HTTPs WebUI.

```
Switch# configure terminal
Switch (config)# ip http secure-server
```

4.2.78 ip igmp host-proxy

Command:

```
ip igmp host-proxy
```

ip Internet Protocol
igmp Internet Group Management Protocol
host-proxy IGMP proxy configuration

Default:

Disabled

Usage Guide:

To enable **IGMP Proxy**

Example:

To enable **IGMP Proxy**.

```
Switch# configure terminal
Switch (config)# ip igmp host-proxy
```

4.2.79 ip igmp host-proxy leave-proxy

Command:

```
ip igmp host-proxy leave-proxy
```

ip Internet Protocol
igmp Internet Group Management Protocol
host-proxy IGMP proxy configuration
leave-proxy IGMP proxy for leave configuration

Default:

Disabled

Usage Guide:

To enable **IGMP leave-proxy**

Example:

To enable **IGMP leave-proxy**.

```
Switch# configure terminal
Switch (config)# ip igmp host-proxy leave-proxy
```

4.2.80 ip igmp snooping

Command:

```
ip igmp snooping
```

ip Internet Protocol
igmp Internet Group Management Protocol
snooping Snooping IGMP

Default:

Disabled

Usage Guide:

To enable **IGMP Snooping**.

Example:

To enable **IGMP Snooping**.

```
Switch# configure terminal
Switch (config)# ip igmp snooping
```

4.2.81 ip igmp snooping vlan

Command:

```
ip igmp snooping vlan <vlan_list>
```

ip Internet Protocol
igmp Internet Group Management Protocol
snooping Snooping IGMP
vlan IGMP VLAN
<vlan_list> VLAN identifier(s): VID

Default:

Disabled

Usage Guide:

To enable **IGMP Snooping** for specific VLAN.

Example:

To enable **IGMP Snooping** for VLAN 1.

```
Switch# configure terminal
Switch (config)# ip igmp snooping vlan 1
```

4.2.82 ip igmp ssm-range

Command:

```
ip igmp ssm-range <ipv4_mcast> <Ipv4PrefixLength : 4-32>
```

ip Internet Protocol

igmp Internet Group Management Protocol

ssm-range IPv4 address range of Source Specific Multicast

<ipv4_mcast> Valid IPv4 multicast address

<vlan_list> VLAN identifier(s): VID

<Ipv4PrefixLength : 4-32> Prefix length ranges from 4 to 32

Default:

232.0.0.0/8

Usage Guide:

To enable **SSM Range** of **IGMP**.

Example:

To enable **SSM Range** (239.239.239.239/32) of **IGMP**.

```
Switch# configure terminal
Switch (config)# ip igmp ssm-range 239.239.239.239 32
```

4.2.83 ip igmp unknown-flooding

Command:

```
ip igmp unknown-flooding
```

ip Internet Protocol
igmp Internet Group Management Protocol
unknown-flooding Flooding unregistered IPv4 multicast traffic

Default:

Enabled

Usage Guide:

To flood unregistered **IPv4 multicast** traffic.

Example:

To flood unregistered **IPv4 multicast** traffic.

```
Switch# configure terminal
Switch (config)# ip igmp unknown-flooding
```

4.2.84 ip name-server

Command:

```
ip name-server <ipv4_ucast>
```

ip Internet Protocol
name-server Domain Name System
<ipv4_ucast> A valid IPv4 unicast address

Default:

Enabled

Usage Guide:

To configure DNS server IP address.

Example:

To configure DNS server IP address (8.8.8.8).

```
Switch# configure terminal
Switch (config)# ip name-server 8.8.8.8
```

4.2.85 ip name-server dhcp

Command:

ip name-server dhcp

ip Internet Protocol
name-server Domain Name System
dhcp Dynamic Host Configuration Protocol

Default:

None

Usage Guide:

To configure DNS IP address via DHCP Server.

Example:

To configure DNS IP address via DHCP Server.

```
Switch# configure terminal
Switch (config)# ip name-server 8.8.8.8
```

4.2.86 ip name-server dhcp interface vlan

Command:

```
ip name-server dhcp interface vlan <vlan_id>
```

ip Internet Protocol
name-server Domain Name System
dhcp Dynamic Host Configuration Protocol
vlan VLAN Interface
<vlan_id> VLAN identifier(s): VID

Default:

None

Usage Guide:

To configure DNS IP address via specific VLAN DHCP Server.

Example:

To configure DNS IP address via specific VLAN 5 DHCP Server.

```
Switch# configure terminal
Switch (config)# ip name-server dhcp interface vlan 5
```

4.2.87 ip route

Command:

```
ip route <ipv4_addr> <ipv4_netmask> <ipv4_gateway>
```

ip Internet Protocol
route Add IP route
<ipv4_addr> Network
<ipv4_netmask> Netmask
<ipv4_gateway> Gateway

Default:

None

Usage Guide:

To configure **static route**

Example:

To configure **static route** as **below table**.

Network	Mask Length	Gateway
192.168.1.0	24	192.168.0.1

```
Switch# configure terminal
Switch (config)# ip route 192.168.1.0 255.255.255.0 192.168.0.1
```

4.2.88 ip routing

Command:

```
ip routing
```

ip Internet Protocol
routing Enable routing for IPv4 and IPv6

Default:

None

Usage Guide:

To enable **IP routing**

Example:

To enable **IP routing**

```
Switch# configure terminal
Switch (config)# ip routing
```

4.2.89 ip source binding interface

Command:

```
ip source binding interface 10GigabitEthernet | GigabitEthernet <port_type_id>
<ipv4_ucast> <ipv4_netmask>
```

ip Internet Protocol
source source command
binding ip source binding
interface ip source binding entry interface config
<ipv4_ucast> Select an IP Address to configure
<ipv4_netmask> Select a subnet mask to configure

Default:

None

Usage Guide:

To enable **Static IP Source Guard Table** for **specific interface**

Example:

To enable **Static IP Source Guard Table** as below table for **GigabitEthernet 1/1**

Port	VLAN ID	IP Address	IP Mask
1	1	192.168.0.77	255.255.255.255

```
Switch# configure terminal
Switch (config)# ip source binding interface GigabitEthernet 1/1 1 192.168.0.77
255.255.255.255
```

4.2.90 ip ssh

Command:

```
ip ssh
```

ip Internet Protocol
ssh Secure Shell

Default:

None

Usage Guide:

To enable **SSH service**

Example:

To enable **SSH service**

```
Switch# configure terminal
Switch (config)# ip ssh
```

4.2.91 ip verify source

Command:

```
ip verify source
```

ip Internet Protocol
verify verify command
source verify source

Default:

Disabled

Usage Guide:

To enable **IP Source Guard**

Example:

To enable **IP Source Guard**

```
Switch# configure terminal
Switch (config)# ip verify source
```

4.2.92 ip verify source translate

Command:

```
ip verify source translate
```

ip Internet Protocol
verify verify command
source verify source

translate ip verify source translate all entries

Default:

Disabled

Usage Guide:

To translate dynamic entries to **IP Source Guard table**

Example:

To translate dynamic entries to **IP Source Guard table**

```
Switch# configure terminal
Switch (config)# ip verify source translate
```

4.2.93 ipmc profile

Command:

```
ipmc profile
```

ipmc IPv4/IPv6 multicast configuration

profile IPMC profile configuration

Default:

Disabled

Usage Guide:

To enable **IPMC profile**

Example:

To enable **IPMC profile**

```
Switch# configure terminal
Switch (config)# ipmc profile
```

4.2.94 ipmc profile <word16>

Command:

```
ipmc profile <word16>
```

ipmc IPv4/IPv6 multicast configuration

profile IPMC profile configuration

<word16> Profile name

Default:

Disabled

Usage Guide:To enter **IPMC profile mode****Example:**To enter **IPMC profile mode** (planet)

```
Switch# configure terminal
Switch (config)# ipmc profile planet
Switch (config-ipmc-profile)#
```

4.2.94.1 default range

Command:

```
default range <EntryName : word16>
```

default Set a command to its defaults**range** A range of IPv4/IPv6 multicast addresses for the profile**<EntryName : word16>** Range entry name**Default:**

None

Usage Guide:To default **IPMC Profile Rule** for specific **IPMC Profile****Example:**To default **IPMC Profile Rule** (Entry 1) for specific **IPMC Profile** (planet)

```
Switch# configure terminal
Switch (config)# ipmc profile planet
Switch (config-ipmc-profile)# default range 1
```

4.2.94.2 description

Command:

```
description <ProfileDesc : line64>
```

description Additional description about the profile**<ProfileDesc : line64>** Description for the designated IPMC filtering profile

Default:

None

Usage Guide:

To configure description for specific **IPMC Profile**

Example:

To configure description (999) for specific **IPMC Profile** (planet)

```
Switch# configure terminal
Switch (config)# ipmc profile planet
Switch (config-ipmc-profile)# description 999
```

4.2.94.3 do

Command:

```
do < exec commands >
```

do To run exec commands in config mode

Default:

N/A

Usage Guide:

To run **exec commands**

Example:

To run "show aaa".

```
Switch# configure terminal
Switch (config)# ipmc profile planet
Switch (config-ipmc-profile)# do show aaa
console : local
telnet : local
ssh : local
http : local
```

4.2.94.4 end

Command:

```
end
```

end Go back to EXEC mode

Default:

Auto

Usage Guide:

To back to **EXEC mode**

Example:

To back to **EXEC mode**

```
Switch# configure terminal
Switch (config)# ipmc profile planet
Switch (config-ipmc-profile)#end
Switch#
```

4.2.94.5 exit

Command:

```
exit
```

exit Exit from current mode

Default:

None

Usage Guide:

To exit current mode

Example:

To exit current mode.

```
Switch# configure terminal
Switch (config)# ipmc profile planet
Switch (config-ipmc-profile)# exit
Switch (config)#
```

4.2.94.6 no

Command:

```
no
```

no Negate a command or set its defaults

Default:

N/A

Usage Guide:

To default the function.

Example:To enable the function (**description 999**).

```
Switch# configure terminal
Switch (config)# ipmc profile planet
Switch (config-ipmc-profile)# no description 999
```

4.2.94.7 range

Command:

```
range <EntryName : word16> deny | permit
```

description Additional description about the profile**<EntryName : word16>** Range entry name**deny** Deny matching addresses**permit** Permit matching addresses**Default:**

Deny

Usage Guide:To configure **action** of **entry** for specific **IPMC Profile****Example:**To configure **action** (permit) of **entry** (1) for specific **IPMC Profile** (planet)

```
Switch# configure terminal
Switch (config)# ipmc profile planet
Switch (config-ipmc-profile)# range 1 permit
```

4.2.95 ipv6 mld host-proxy

Command:

```
ipv6 mld host-proxy
```

ipv6 IPv6 configuration commands**mld** Multicast Listener Discovery

host-proxy MLD proxy configuration

Default:

Disabled

Usage Guide:

To enable **MLD Proxy**

Example:

To enable **MLD Proxy**.

```
Switch# configure terminal
Switch (config)# ipv6 mld host-proxy
```

4.2.96 ipv6 mld host-proxy leave-proxy

Command:

```
ipv6 mld host-proxy leave-proxy
```

ipv6 IPv6 configuration commands
mld Multicast Listener Discovery
host-proxy MLD proxy configuration
leave-proxy MLD proxy for leave configuration

Default:

Disabled

Usage Guide:

To enable **MLD leave-proxy**

Example:

To enable **MLD leave-proxy**.

```
Switch# configure terminal
Switch (config)# ipv6 mld host-proxy leave-proxy
```

4.2.97 ipv6 mld snooping

Command:

```
ipv6 mld snooping
```

ipv6 IPv6 configuration commands
mld Multicast Listener Discovery
snooping Snooping MLD

Default:

Disabled

Usage Guide:To enable **MLD Snooping**.**Example:**To enable **MLD Snooping**.

```
Switch# configure terminal
Switch (config)# ipv6 mld snooping
```

4.2.98 ipv6 mld snooping vlan

Command:

```
ipv6 mld snooping vlan <vlan_list>
```

ipv6 IPv6 configuration commands
mld Multicast Listener Discovery
snooping Snooping MLD
vlan MLD VLAN
<vlan_list> VLAN identifier(s): VID

Default:

Disabled

Usage Guide:To enable **MLD Snooping for specific VLAN**.**Example:**To enable **MLD Snooping for VLAN 1**.

```
Switch# configure terminal
Switch (config)# ipv6 mld snooping vlan 1
```

4.2.99 ipv6 mld ssm-range

Command:

```
ipv6 mld ssm-range <ipv6_mcast> <Ipv6PrefixLength : 8-128>
```

ipv6 IPv6 configuration commands
mld Multicast Listener Discovery
ssm-range IPv6 address range of Source Specific Multicast
<ipv6_mcast> Valid IPv6 multicast address

<IPv6PrefixLength : 8-128> Prefix length ranges from 8 to 128

Default:

ff3e::/96

Usage Guide:

To enable **SSM Range** of **MLD**.

Example:

To enable **SSM Range** (ff3e::7788/128) of **MLD**.

```
Switch# configure terminal
Switch (config)# ipv6 mld ssm-range ff3e::7788 128
```

4.2.100 ipv6 mld unknown-flooding

Command:

```
ipv6 mld unknown-flooding
```

ipv6 IPv6 configuration commands
mld Multicast Listener Discovery
unknown-flooding Flooding unregistered IPv6 multicast traffic

Default:

Enabled

Usage Guide:

To flood unregistered **IPv6 multicast** traffic.

Example:

To flood unregistered **IPv6 multicast** traffic.

```
Switch# configure terminal
Switch (config)# ipv6 mld unknown-flooding
```

4.2.101 ipv6 route

Command:

```
ipv6 route <X:X:X:X::X/<0-128>> {<X:X:X:X::X>, interface vlan <vlan_id>
<FE80::X:X:X >}
```

ipv6 IPv6 configuration commands
route Add IP route
<X:X:X:X::X/<0-128>> IPv6 prefix x:x::y/z

<X:X:X:X::X> IPv6 unicast address (except link-local address) of next-hop

interface Select an interface to configure

vlan VLAN Interface

<vlan_id> VLAN identifier(s): VID

<FE80::X:X:X> IPv6 link-local address of next-hop

Default:

None

Usage Guide:

To configure **static route** for IPv6

Example 1:

To configure **static route** as **below table** for IPv6.

Network	Mask Length	Gateway	Next Hop VLAN
2001::7788	128	2002::1	0

```
Switch# configure terminal
Switch (config)# ipv6 route 2001::7788/128 2002::1
```

Example 2:

To configure **static route** as **below table** for IPv6.

Network	Mask Length	Gateway	Next Hop VLAN
2001::7788	128	fe80::1	1

```
Switch# configure terminal
Switch (config)# ipv6 route 2001::7788/128 interface vlan 1 fe80::1
```

4.2.102 lacp system-priority

Command:

```
lacp system-priority <1-65535>
```

lacp LACP settings

system-priority System priority

<1-65535> Priority value, lower means higher priority

Default:

32768

Usage Guide:

To configure **LACP system-priority**.

Example:

To configure **LACP system-priority** (99).

```
Switch# configure terminal
Switch (config)# lacp system-priority 99
```

4.2.103 line

Command:

```
line { <0~16> | console 0 | vty <0~15> }
```

line Configure a terminal line
<0~16> List of line numbers
console Console terminal line
vtty Virtual terminal

Default:

N/A

Usage Guide:

To enter **line mode**

Example:

To enter **line mode (vty 1)**

```
Switch# configure terminal
Switch (config)# line vty 1
Switch (config-line)#
```

4.2.103.1 do

Command:

```
do < exec commands >
```

do To run exec commands.

Default:

N/A

Usage Guide:

To run **exec commands**.

Example:

To run "show aaa".

```
Switch# configure terminal
Switch (config)# line vty 1
Switch (config-line)# do show aaa
console : local
telnet  : local
ssh    : local
http   : local
```

4.2.103.2 editing

Command:

```
editing
```

editing Enable command line editing

Default:

Enabled

Usage Guide:

To allow user editing command line.

Example:

To allow user editing command line.

```
Switch# configure terminal
Switch (config)# line vty 1
Switch (config-line)# editing
```

4.2.103.3 end

Command:

```
end
```

end Go back to EXEC mode

Default:

None

Usage Guide:

To back to **EXEC mode**

Example:

To back to **EXEC mode**

```
Switch# configure terminal
Switch (config)# line vty 1
Switch (config-line)#end
Switch#
```

4.2.103.4 exec-banner

Command:

```
exec-banner
```

exec-banner Enable the display of the EXEC banner

Default:

Enabled

Usage Guide:

To enable the display of the **EXEC banner**

Example:

To enable the display of the **EXEC banner**

```
Switch# configure terminal
Switch (config)# line vty 1
Switch (config-line)# exec-banner
```

4.2.103.5 exec-timeout

Command:

```
exec-timeout <0-1440>
```

exec-timeout Set the EXEC timeout

<0-1440> Timeout in minutes

Default:

N/A

Usage Guide:To configure **EXEC timeout****Example:**To configure **EXEC timeout** (10 minutes)

```
Switch# configure terminal
Switch (config)# line vty 1
Switch (config-line)# exec-timeout 10
```

4.2.103.6 exec-timeout

Command:

```
exec-timeout <0-1440>
```

exec-timeout Set the EXEC timeout**<0-1440>** Timeout in minutes**Default:**

N/A

Usage Guide:To configure **EXEC timeout****Example:**To configure **EXEC timeout** (10 minutes)

```
Switch# configure terminal
Switch (config)# line vty 1
Switch (config-line)# exec-timeout 10
```

4.2.103.7 exit

Command:

```
exit
```

exit Exit from current mode**Default:**

None

Usage Guide:

To exit current mode

Example:

To exit current mode.

```
Switch# configure terminal
Switch (config)# line vty 1
Switch (config-line)# exit
Switch (config)#
```

4.2.103.8 history size

Command:

```
history size <0-32>
```

history Control the command history function

size Set history buffer size

<0-32> Number of history commands, 0 means disable

Default:

None

Usage Guide:

To exit current mode

Example:

To exit current mode.

```
Switch# configure terminal
Switch (config)# line vty 1
Switch (config-line)# history size 1
```

4.2.103.9 length

Command:

```
length <0 or 3-512>
```

length Set number of lines on a screen

<0 or 3-512> Number of lines on screen (0 for no pausing)

Default:

None

Usage Guide:

To configure displayed lines on a screen.

Example:

To configure displayed lines on a screen.

```
Switch# configure terminal
Switch (config)# line vty 1
Switch (config-line)# length 10
```

4.2.103.10 location

Command:

```
location <LINE>
```

location Enter terminal location description

<LINE> One text line describing the terminal's location

Default:

None

Usage Guide:

To configure description of location.

Example:

To configure description (**taiwan**) of location.

```
Switch# configure terminal
Switch (config)# line vty 1
Switch (config-line)# location taiwan
```

4.2.103.11 motd-banner

Command:

```
motd-banner
```

motd-banner Enable the display of the MOTD banner

Default:

Enabled

Usage Guide:

To enable MOTD banner.

Example:

To enable MOTD banner..

```
Switch# configure terminal
Switch (config)# line vty 1
Switch (config-line)# motd-banner
```

4.2.103.12 no

Command:

```
no
```

no Negate a command or set its defaults

Default:

N/A

Usage Guide:

To default the function

Example:

To disable the function (**motd-banner**) for **vtty 1**

```
Switch# configure terminal
Switch (config)# line vty 1
Switch (config-line)# no motd-banner
```

4.2.103.13 privilege level

Command:

```
privilege level <0-15>
```

privilege Change privilege level for line
level Assign default privilege level for line
<0-15> Default privilege level for line

Default:

15

Usage Guide:

To configure privilege level

Example:

To configure privilege level (5) for **vtty 1**.

```
Switch# configure terminal
Switch (config)# line vty 1
Switch (config-line)# privilege level 5
```

4.2.103.14 width

Command:

```
width <0 or 40-512>
```

width Set width of the display terminal
<0 or 40-512> Number of characters on a screen line (0 for unlimited width)

Default:

0

Usage Guide:

To configure width of the display terminal.

Example:

To configure width (50) of the display terminal for **vtty 1**.

```
Switch# configure terminal
Switch (config)# line vty 1
Switch (config-line)# width 50
```

4.2.104 lldp holdtime

Command:

```
lldp holdtime <2-10>
```

lldp LLDP configurations.
holdtime Sets LLDP hold time (The neighbor switch will discarded the LLDP information after "hold time" multiplied with "timer" seconds).
<2-10> 2-10 seconds

Default:

4

Usage Guide:

To enable **LLDP hold time**

Example:

To enable **LLDP hold time (5)**

```
Switch# configure terminal
Switch (config)# lldp holdtime 5
```

4.2.105 lldp med datum

Command:

```
lldp med datum nad83-mlw | nad83-navd88 | wgs84
```

lldp	LLDP configurations.
med	Media Endpoint Discovery
datum	Datum (geodetic system) type
nad83-mlw	Mean lower low water datum 1983
nad83-navd88	North American vertical datum 1983
wgs84	World Geodetic System 1984

Default:

WGS84

Usage Guide:

To configure **Datum type** of **LLDP**

Example:

To configure **Datum type (nad83-mlw)** of **LLDP**

```
Switch# configure terminal
Switch (config)# lldp med datum nad83-mlw
```

4.2.106 lldp med fast

Command:

```
lldp med fast <1-10>
```

lldp	LLDP configurations.
med	Media Endpoint Discovery
fast	Number of times to repeat LLDP frame transmission at fast start.

Default:

Usage Guide:

To configure **frame transmission time** of LLDP

Example:

To configure **frame transmission time (6)** of LLDP

```
Switch# configure terminal
Switch (config)# lldp med fast 6
```

4.2.107 lldp med location-tlv altitude

Command:

```
lldp med location-tlv altitude [floors <Meters or floors>] | [meters <Meters or floors>]
```

lldp LLDP configurations.
med Media Endpoint Discovery
location-tlv LLDP-MED Location Type Length Value parameter
altitude Altitude parameter
floors Specify the altitude in floor.
<Meters or floors> Altitude value.
meters Specify the altitude in meters.

Default:

0

Usage Guide:

To configure **altitude** of LLDP-MED

Example:

To configure **altitude (Floors 5)** of LLDP-MED

```
Switch# configure terminal
Switch (config)# lldp med location-tlv altitude floors 5
```

4.2.108 lldp med location-tlv elin-addr

Command:

```
lldp med location-tlv elin-addr <ELIN number>
```

lldp LLDP configurations.
med Media Endpoint Discovery
location-tlv LLDP-MED Location Type Length Value parameter

elin-addr Emergency Location Identification Number, (e.g. E911 and others), such as defined by TIA or NENA.

<ELIN number> ELIN value

Default:

0

Usage Guide:

To configure **Emergency Location Identification Number** of **LLDP-MED**

Example:

To configure **Emergency Location Identification Number (911)** of **LLDP-MED**

```
Switch# configure terminal
Switch (config)# lldp med location-tlv elin-addr 911
```

4.2.109 lldp med location-tlv latitude

Command:

```
lldp med location-tlv latitude north <Degrees> | south <Degrees>
```

- lldp** LLDP configurations.
- med** Media Endpoint Discovery
- location-tlv** LLDP-MED Location Type Length Value parameter
- latitude** Latitude parameter
- north** Setting latitude direction to north.
- south** Setting latitude direction to south
- <Degrees>** Latitude degrees (0.0000-90.0000)

Default:

North, 0

Usage Guide:

To configure **latitude direction** of **LLDP-MED**

Example:

To configure **latitude direction (south, 5)** of **LLDP-MED**

```
Switch# configure terminal
Switch (config)# lldp med location-tlv latitude south 5
```

4.2.110 lldp med location-tlv longitude

Command:

```
lldp med location-tlv longitude east <Degrees> | west <Degrees>
```

lldp LLDP configurations.
med Media Endpoint Discovery
location-tlv LLDP-MED Location Type Length Value parameter
longitude Longitude parameter
east Setting longitude direction to east.
west Setting longitude direction to west.
<Degrees> Longitude degrees (0.0000-180.0000)

Default:

North, 0

Usage Guide:

To configure **longitude direction** of **LLDP-MED**

Example:

To configure **longitude direction** (east, 5) of **LLDP-MED**

```
Switch# configure terminal
Switch (config)# lldp med location-tlv longitude east 5
```

4.2.111 lldp med media-vlan-policy

Command:

```
lldp med media-vlan-policy <Index : 0-31> {guest-voice | guest-voice-signaling  
softphone-voice | streaming-video | video-conferencing | video-signaling | voice |  
voice-signaling} {tagged | untagged} <vlan_id> dscp <0-63> l2-priority <0-7>
```

lldp LLDP configurations.
med Media Endpoint Discovery
media-vlan-policy Use the media-vlan-policy to create a policy, which can be assigned to an interface.
<Index : 0-31> Policy id for the policy which is created.
guest-voice Create a guest voice policy.
guest-voice-signaling Create a guest voice signaling policy.
softphone-voice Create a softphone voice policy.
streaming-video Create a streaming video policy.
video-conferencing Create a video conferencing policy.
video-signaling Create a video signaling policy.
voice Create a voice policy.
voice-signaling Create a voice signaling policy.
tagged The policy uses tagged frames.
untagged The policy uses un-tagged frames.

<vlan_id> The VLAN the policy uses tagged frames.

dscp Differentiated Services Code Point.

<0-63> DSCP value 0-63

I2-priority Layer 2 priority.

<0-7> Priority 0-7

Default:

0

Usage Guide:

To configure **media-VLAN-policy** of **LLDP-MED**

Example:

To configure **media-VLAN-policy** as below table of **LLDP-MED**

Policy ID	Application Type	Tag	VLAN ID	L2 Priority	DSCP
1	Guest Voice	Tagged	1	5	45

```
Switch# configure terminal
Switch (config)# lldp med media-vlan-policy 1 guest-voice tagged 1 dscp 45 I2-priority
5
```

4.2.112 lldp reinit

Command:

```
lldp reinit <1-10>
```

lldp LLDP configurations.

reinit LLDP tx reinitialization delay in seconds

<1-10> 1-10 seconds.

Default:

2

Usage Guide:

To configure **Tx re-initialization delay time** of **LLDP**

Example:

To configure **Tx re-initialization delay time (5)** of **LLDP**

```
Switch# configure terminal
Switch (config)# lldp reinit 5
```

4.2.113 Ildp timer

Command:

```
Ildp timer <5-32768>
```

Ildp LLDP configurations.

timer Sets LLDP TX interval (The time between each LLDP frame transmitted in seconds)

<5-32768> 5-32768 seconds.

Default:

30

Usage Guide:

To configure **Tx interval time** of LLDP

Example:

To configure **Tx interval time** (555) of LLDP

```
Switch# configure terminal
Switch (config)# Ildp timer 555
```

4.2.114 Ildp transmission-delay

Command:

```
Ildp transmission-delay <1-8192>
```

Ildp LLDP configurations.

transmission-delay Sets LLDP transmission-delay. LLDP transmission delay (the amount of time that the transmission of LLDP frames will be delayed after LLDP configuration has changed) in seconds.)

<1-8192> 1-8192 seconds.

Default:

2

Usage Guide:

To configure **Tx transmission-delay** time of LLDP

Example:

To configure **Tx transmission-delay** time (88) of LLDP

```
Switch# configure terminal
Switch (config)# lldp transmission-delay 88
```

4.2.115 logging host

Command:

```
logging host <hostname> | <ipv4_ucast>
```

logging Syslog
host host
<hostname> Domain name of the log server
<ipv4_ucast> IP address of the log server

Default:

0

Usage Guide:

To configure address of **log server**

Example:

To configure address of **log server**

```
Switch# configure terminal
Switch (config)# logging host 192.168.5.5
```

4.2.116 logging level

Command:

```
logging level error | info | warning
```

logging Syslog
level level
error Error
info Information
warning Warning

Default:

Info

Usage Guide:

To configure level of **log server**

Example:

To configure level of **log server**

```
Switch# configure terminal
Switch (config)# logging level error
```

4.2.117 logging on

Command:

```
logging on
```

logging Syslog

on Enable syslog server

Default:

Disabled

Usage Guide:

To enable **log server**

Example:

To enable **log server**

```
Switch# configure terminal
Switch (config)# logging on
```

4.2.118 loop-protect

Command:

```
loop-protect
```

loop-protect Loop protection configuration

Default:

Disabled

Usage Guide:

To enable **Loop Protection**

Example:

To enable **Loop Protection**

```
Switch# configure terminal
Switch (config)# loop-protect
```

4.2.119 loop-protect shutdown-time

Command:

```
loop-protect shutdown-time <0-604800>
```

loop-protect Loop protection configuration
shutdown-time Loop protection shutdown time interval
<0-604800> Shutdown time in second

Default:

180

Usage Guide:

To configure **shutdown time interval** of **Loop Protection**

Example:

To configure **shutdown time interval** (888) of **Loop Protection**

```
Switch# configure terminal
Switch (config)# loop-protect shutdown-time 888
```

4.2.120 loop-protect transmit-time

Command:

```
loop-protect transmit-time <0-10>
```

loop-protect Loop protection configuration
transmit-time Loop protection transmit time interval
<1-10> Transmit time in second

Default:

5

Usage Guide:

To configure **Transmission Time of Loop Protection**

Example:

To configure **Transmission Time (8) of Loop Protection**

```
Switch# configure terminal
Switch (config)# loop-protect transmit-time 8
```

4.2.121 mac address-table aging-time

Command:

```
mac address-table aging-time <0,10-1000000>
```

mac MAC table entries/configuration
address-table MAC table entries/configuration
<0,10-1000000> Aging time in seconds, 0 disables aging

Default:

300

Usage Guide:

To configure **Aging Time of MAC Address Table**

Example:

To configure **Aging Time (888) of MAC Address Table**

```
Switch# configure terminal
Switch (config)# mac address-table aging-time 888
```

4.2.122 mac address-table static

Command:

```
mac address-table static <mac_addr> vlan <vlan_id> interface * | 10GigabitEthernet
<port_type_list> | GigabitEthernet <port_type_list>
```

mac MAC table entries/configuration
address-table MAC table entries/configuration
static Static MAC address
<mac_addr> 48 bit MAC address: xx:xx:xx:xx:xx:xx
vlan VLAN keyword
<vlan_id> VLAN IDs 1-4095

- interface** Select an interface to configure
- * All switches or All ports
- GigabitEthernet** 1 Gigabit Ethernet Port
- 10GigabitEthernet** 10 Gigabit Ethernet Port

Default:

300

Usage Guide:

To configure **Static MAC Address Table**

Example:

To configure **Static MAC Address Table** as below table

VLAN ID	MAC Address	Port Members																												
		1	2	3	4	5	6	7	8	9	10	11	12	13	14	15	16	17	18	19	20	21	22	23	24	25	26	27	28	29
1	00-11-22-33-44-55	<input checked="" type="checkbox"/>	<input type="checkbox"/>	<input type="checkbox"/>	<input type="checkbox"/>	<input type="checkbox"/>	<input type="checkbox"/>	<input type="checkbox"/>	<input type="checkbox"/>	<input type="checkbox"/>	<input type="checkbox"/>	<input type="checkbox"/>	<input type="checkbox"/>	<input type="checkbox"/>	<input type="checkbox"/>	<input type="checkbox"/>	<input type="checkbox"/>	<input type="checkbox"/>	<input type="checkbox"/>	<input type="checkbox"/>	<input type="checkbox"/>	<input type="checkbox"/>	<input type="checkbox"/>	<input type="checkbox"/>	<input type="checkbox"/>	<input type="checkbox"/>	<input type="checkbox"/>	<input type="checkbox"/>	<input type="checkbox"/>	<input type="checkbox"/>

```
Switch# configure terminal
Switch (config)# mac address-table static 00:11:22:33:44:55 vlan 1 interface
GigabitEthernet 1/1
```

4.2.123 mep <Instance> ais

Command:

```
mep <Instance> ais [ fr1m | fr1s ] [ protect ]
```

- mep** Maintenance Entity Point
- <Instance>** The MEP instance number.
- ais** Alarm Indication Signal
- fr1m** Frame rate is 1 f/min.
- fr1s** Frame rate is 1 f/s.
- protect** The AIS can be used for protection. At the point of state change three AIS PDU is transmitted as fast as possible.

Default:

None

Usage Guide:

To configure **AIS of MEP**

Example:

To configure **AIS of MEP 1** as below table

Priority	Frame Rate	Protection
1 f/sec	<input checked="" type="checkbox"/>	<input type="checkbox"/>

```
Switch# configure terminal
Switch (config)# mep 1 ais fr1s
```

4.2.124 mep <Instance> aps

Command:

```
mep <Instance> aps <prio> [ multi | uni ] { laps | { raps [ octet <octet> ] } }
```

- mep** Maintenance Entity Point
- <Instance>** The MEP instance number.
- aps** Automatic Protection Switching protocol
- laps** Linear Automatic Protection Switching protocol.
- multi** OAM PDU is transmitted with multicast MAC. Must be 'multi' in case of RAPS.
- uni** OAM PDU is transmitted with unicast MAC. The MAC is taken from peer MEP MAC database. Only possible in case of LAPS.
- raps** Ring Automatic Protection Switching protocol.
- octet** Then last OCTET in the multicast MAC. Only possible in case of RAPS.
- <Octet : uint>** Last OCTET value
- uni** OAM PDU is transmitted with unicast MAC. The MAC is taken from peer MEP MAC database. Only possible in case of LAPS.

Default:

None

Usage Guide:

To configure APS of MEP

Example:

To configure APS of MEP 1 as below table

APS Protocol			
Priority	Cast	Type	Last Octet
7	Multi	L-APS	1

```
Switch# configure terminal
Switch (config)# mep 1 aps 7 laps
```

4.2.125 mep <Instance> cc

Command:

```
mep <Instance> cc <Prio : 0-7> fr100s | fr10s | fr1m | fr1s | fr300s | fr6h | fr6m
```

- mep** Maintenance Entity Point
- <Instance>** The MEP instance number.
- cc** Continuity Check
- <Prio : 0-7>** Priority in case of tagged OAM. In the EVC domain this is the COS-ID.
- fr100s** Frame rate is 100 f/s.
- fr10s** Frame rate is 10 f/s.
- fr1m** Frame rate is 1 f/min.
- fr1s** Frame rate is 1 f/s.
- fr300s** Frame rate is 300 f/s.
- fr6h** Frame rate is 6 f/hour.
- fr6m** Frame rate is 6 f/min.

Default:

Priority	Frame rate
0	1 f/sec ▼

Usage Guide:

To configure **CC** of **MEP**

Example:

To configure **CC** of **MEP 1** as below table

Priority	Frame rate
2	10 f/sec ▼

```
Switch# configure terminal
Switch (config)# mep 1 cc 2 fr10s
```

4.2.126 mep <Instance> client domain

Command:

```
mep <Instance> client domain { evc | vlan }
```

- mep** Maintenance Entity Point
- <Instance>** The MEP instance number.
- client** Transport layer Client
- evc** EVC Domain.
- vlan** Vlan Domain

Default:

EVC

Usage Guide:

To configure **Client Domain** of **MEP**

Example:

To configure **Client Domain** (EVC) of **MEP 1**

```
Switch# configure terminal
Switch (config)# mep 1 client domain evc
```

4.2.127 mep <Instance> client flow

Command:

```
mep <Instance> client flow <cflow> level <level> [ ais-prio [ <aisprio> | ais-highest ] ]
[ lck-prio [ <lckprio> | lck-highest ] ]
```

- mep** Maintenance Entity Point
- <Instance>** The MEP instance number.
- level** The MEG level on the client layer
- <Level : 0-7>** The MEG level value
- ais-prio** AIS injection priority
- <Aisprio : 0-7>** AIS injection priority value
- ais-highest** Request the highest possible AIS priority
- lck-prio** LCK injection priority
- <Lckprio : 0-7>** LCK injection priority value.
- lck-highest** Request the highest possible LCK priority.

Default:

0

Usage Guide:

To configure **Client Flow** of **MEP**

Example:

To configure **Client Flow** of **MEP 1** as below table.

Evc	5
Level	4
AIS prio	High
LCK prio	3

```
Switch# configure terminal
Switch (config)# mep 1 client flow 5 level 4 ais-prio ais-highest lck-prio 3
```

4.2.128 mep <Instance> dm

Command:

```
mep <Instance> dm <prio> [ multi | { uni mep-id <mepid> } ] [ single | dual ] [ rdtrp |
flow ] interval <interval> last-n <lastn>
```

- mep** Maintenance Entity Point
- <Instance>** The MEP instance number.
- dm** Delay Measurement
- <Prio : 0-7>** Priority in case of tagged OAM. In the EVC domain this is the COS-ID
- dual** Delay Measurement based on 1DM PDU transmission.
- flow** The two way delay is calculated as round trip symmetrical flow delay. The far end residence time is subtracted.
- interval** Interval between PDU transmission in 10ms. Min value is 10.
- <Interval : uint>** Interval value
- multi** OAM PDU is transmitted with multicast MAC.
- rdtrp** The two way delay is calculated as round trip delay. The far end residence time is not subtracted.
- single** Delay Measurement based on DMM/DMR PDU.
- uni** OAM PDU is transmitted with unicast MAC. The MAC is taken from peer MEP MAC database.
- mep-id** Peer MEP-ID for unicast DM. The MAC is taken from peer MEP MAC database.
- <Mepid : uint>** Peer MEP-ID value
- last-n** The last N delays used for average last N calculation. Min value is 10.
- <Lastn : uint>** The last N value

Default:

0

Usage Guide:

To configure **Delay Measurement** of **MEP**

Example:

To configure **Delay Measurement** of **MEP 1** as below table.

Priority	Cast	Peer MEP	Way	Tx Mode	Calc	Gap	Count
5	Multi	0	Two-way	Standardize	Round trip	10	10

```
Switch# configure terminal
Switch (config)# mep 1 dm 5 rdtrp interval 10 last-n 10
```

4.2.129 mep <Instance> dm ns

Command:

```
mep <Instance> dm ns
```

mep Maintenance Entity Point
<Instance> The MEP instance number.
dm Delay Measurement
ns Nano Seconds

Default:

us

Usage Guide:

To configure **Delay Measurement** of **MEP**

Example:

To configure **Delay Measurement unit (ns)** of **MEP 1** as below table.

Priority	Cast	Peer MEP	Way	Tx Mode	Calc	Gap	Count
5	Multi ▼	0	Two-way ▼	Standardize ▼	Round trip ▼	10	10

```
Switch# configure terminal
Switch (config)# mep 1 dm ns
```

4.2.130 mep <Instance> dm overflow-reset

Command:

```
mep <Instance> dm overflow-reset
```

mep Maintenance Entity Point
<Instance> The MEP instance number.
dm Delay Measurement
overflow-reset Reset all Delay Measurement results on total delay counter overflow.

Default:

Keep

Usage Guide:To reset **Delay Measurement** of **MEP** while overflowing**Example:**To reset **Delay Measurement** of **MEP 1** while overflowing

```
Switch# configure terminal
Switch (config)# mep 1 dm overflow-reset
```

4.2.131 mep <Instance> dm proprietary

Command:

```
mep <Instance> dm proprietary
```

mep Maintenance Entity Point**<Instance>** The MEP instance number.**dm** Delay Measurement**proprietary** Proprietary Delay Measurement**Default:**

Standard

Usage Guide:To configure **Tx mode (proprietary)** of MEP.**Example:**To configure **Tx mode (proprietary)** of MEP 1

```
Switch# configure terminal
Switch (config)# mep 1 dm proprietary
```

4.2.132 mep <Instance> dm synchronized

Command:

```
mep <Instance> dm synchronized
```

mep Maintenance Entity Point**<Instance>** The MEP instance number.**dm** Delay Measurement**synchronized** Near end and far end is real time synchronized.

Default:

Enabled

Usage Guide:

To configure **Time Sync** of **MEP**.

Example:

To configure **Time Sync** of **MEP 1**

```
Switch# configure terminal
Switch (config)# mep 1 dm synchronized
```

4.2.133 mep <Instance> down

Command:

```
mep <Instance> [ mip ] down domain { port | evc | vlan } [ vid <vid> ] flow <flow>
level <level> interface <port_type> <port>
```

- mep** Maintenance Entity Point
- mip** This MEP instance is a half-MIP
- <Instance>** The MEP instance number.
- down** This MEP is a Down-MEP
- domain** The domain of the MEP
- evc** This MEP is a EVC domain MEP.
- port** This MEP is a Port domain MEP.
- vlan** This MEP is a VLAN domain MEP.
- flow** The flow instance that the MEP is related to.
- <flow >** The flow instance number when not in the port domain.
- vid** In case the MEP is a port Up-MEP or a EVC customer MIP the VID must be given.
- <Vid : vlan_id>** The port Domain MEP VID. This is required for a Port Up-MEP.

Default:

None

Usage Guide:

To configure **Down-MEP** of **MEP**.

Example:

To configure **Down-MEP** of **MEP 1** as below table

Instance	Domain	Mode	Direction	Residence Port	Level	Flow Instance	Tagged VID
1	Port	Mep	Down	1	0	1	0

```
Switch# configure terminal
```

```
Switch (config)# mep 1 down domain port flow 1 level 0 interface GigabitEthernet 1/1
```

4.2.134 mep <Instance> lb

Command:

```
mep <Instance> lb <prio> [ dei ] [ multi | { uni { { mep-id <mepid> } | { mac <mac> } } } ] count <count> size <size> interval <interval>
```

mep Maintenance Entity Point

<Instance> The MEP instance number.

lb Loop Back

<Prio : 0-7> Priority in case of tagged OAM. In the EVC domain this is the COS-ID.

count The number of LBM PDU to send in one loop test. The value 0 indicate infinite transmission (test behavior). This is HW based LBM/LBR and Requires VOE.

<Count : uint> Number of LBM PDU to send value

size The number of bytes in the LBM PDU Data Pattern TLV

<size> The LBM frame size. This is entered as the wanted size (in bytes) of a un-tagged frame containing LBM OAM PDU - including CRC (four bytes). Example when 'Size' = 64 => Un-tagged frame size = DMAC(6) + SMAC(6) + TYPE(2) + LBM PDU LENGTH(46) + CRC(4) = 64

interval The number of bytes in the LBM PDU Data Pattern TLV

<interval> The interval between transmitting LBM PDU. in case 'count' != 0 this is in 10ms and max is 100. In case 'count' == 0 this is in 1us and max is 10.000.

dei Drop Eligible Indicator in case of tagged OAM.

multi OAM PDU is transmitted with multicast MAC.

uni OAM PDU is transmitted with unicast MAC. The MAC is taken from peer MEP MAC database.

mac Loop Back unicast MAC to be used in case of LB against MIP.

<Mac : mac_addr> Loop Back target unicast MAC value

mep-id Peer MEP-ID for unicast LB. The MAC is taken from peer MEP MAC database.

<Mepid : uint> Peer MEP-ID value

Default:

None

Usage Guide:

To configure **Loop Back** of **MEP**.

Example:

To configure **Loop Back** of **MEP 2** as below table

Dei	Priority	Cast	Peer MEP	Unicast MAC	To Send	Size	Interval
<input checked="" type="checkbox"/>	1	Multi	1	00-00-00-00-00-00	10	64	100

```
Switch# configure terminal
```

```
Switch (config)# mep 2 lb 1 dei count 10 size 64 interval 100
```

4.2.135 mep <Instance> lck

Command:

```
mep <Instance> lck fr1m | fr1s
```

mep Maintenance Entity Point

<Instance> The MEP instance number.

lck Locked Signal

fr1m Frame rate is 1 f/min.

fr1s Frame rate is 1 f/s.

Default:

1 frame/sec

Usage Guide:

To configure **Locked Frame Rate** of **MEP**.

Example:

To configure **Locked Frame Rate** (1 frame/sec) of **MEP 2**.

```
Switch# configure terminal
```

```
Switch (config)# mep 2 lck
```

```
Switch (config)# mep 2 lck fr1s
```

4.2.136 mep <Instance> level

Command:

```
mep <Instance> level <Level : 0-7>
```

mep Maintenance Entity Point

<Instance> The MEP instance number.

level The MEG level of the MEP

<Level : 0-7> The MEG level value

Default:

0

Usage Guide:

To configure **MEG level** of **MEP**.

Example:

To configure **MEG level (2)** of **MEP 2**.

```
Switch# configure terminal
Switch (config)# mep 2 level 2
```

4.2.137 mep <Instance> lm

Command:

```
mep <Instance> lm <prio> [ multi | uni ] [ single | dual ] [ fr10s | fr1s | fr6m | fr1m | fr6h ] [ flr <flr> ]
```

- mep** Maintenance Entity Point
- <Instance>** The MEP instance number.
- lm** Loss Measurement
- <Prio : 0-7>** Priority in case of tagged OAM. In the EVC domain this is the COS-ID.
- fr10s** Frame rate is 10 f/s.
- fr1m** Frame rate is 1 f/min.
- fr1s** Frame rate is 1 f/s.
- fr6h** Frame rate is 6 f/hour.
- fr6m** Frame rate is 6 f/min.
- dual** Dual ended LM is based on CCM PDU.
- single** Single ended LM is based on LMM/LMR PDU.
- multi** OAM PDU is transmitted with multicast MAC.
- uni** OAM PDU is transmitted with unicast MAC. The MAC is taken from peer MEP MAC database. In case of LM there is only one peer MEP.
- flr** The Frame Loss Ratio interval.
- <Flr : uint>** The Frame Loss Ratio interval value.

Default:

Priority	Frame rate	Cast	Ended	FLR Interval
0	1 f/sec	Multi	Single	5

Usage Guide:

To configure **Loss Measurement** of **MEP**.

Example:

To configure **Loss Measurement** of **MEP 2** as below table

Priority	Frame rate	Cast	Ended	FLR Interval
5	1 f/sec	Uni	Single	4

```
Switch# configure terminal
Switch (config)# mep 2 lm 5 uni flr 4
```

4.2.138 mep <Instance> lt

Command:

```
mep <Instance> lt <prio> { { mep-id <mepid> } | { mac <mac> } } ttl <ttl>
```

- mep** Maintenance Entity Point
- <Instance>** The MEP instance number.
- lt** Link Trace
- <Prio : 0-7>** Priority in case of tagged OAM. In the EVC domain this is the COS-ID.
- mac** Link Trace target unicast MAC to be used in case of LT against MIP.
- <Mac : mac_addr>** Link Trace target unicast MAC value.
- mep-id** Peer MEP-ID for Link Trace target unicast MAC. The MAC is taken from peer MEP MAC database.
- <Mepid : uint>** Peer MEP-ID value.
- ttl** Time To Live.
- <Ttl : uint>** Time To Live value

Default:

Priority	Peer MEP	Unicast MAC	Time To Live
0	1	00-00-00-00-00-00	1

Usage Guide:

To configure **Link Trace** of **MEP**.

Example:

To configure **Link Trace** of **MEP 1** as below table

Priority	Peer MEP	Unicast MAC	Time To Live
4	0	11-3A-15-A3-53-44	5

```
Switch# configure terminal
Switch (config)# mep 1 lt 4 mac 11-3A-15-A3-53-44
```

4.2.139 mep <Instance> meg-id

Command:

```
mep <Instance> meg-id <megid> { itu | itu-cc | { ieee [ name <name> ] } }
```

- mep** Maintenance Entity Point

<Instance> The MEP instance number.

meg-id The ITU/IEEE MEG-ID

<Megid : word> The MEG-ID string. This is either the ITU MEG-ID or the IEEE Short MA, depending on the selected MEG-ID format. The ITU max. is 13 characters. The ITU-CC max. is 15 characters. The IEEE max. is 16 characters..

ieee The MEG-ID (Short MA Name) has IEEE Character String format. The meg-id max. is 16 characters.

itu The MEG-ID has ITU format (ICC - UMC). The meg-id max. is 13 characters.

itu-cc The MEG-ID has ITU Country Code format (CC - ICC - UMC). The meg-id max. is 15 characters

name Only relevant for IEEE. The MAID is with Maintenance Domain Name

<Name : word> Maintenance Domain Name string. The max is 16 characters

Default:

Format	Domain Name	MEG id	MEP id
ITU ICC		ICC000MEG0000	1

Usage Guide:

To configure **MEG-ID** of **MEP**.

Example:

To configure **MEG-ID** of **MEP 1** as below table

Format	Domain Name	MEG id	MEP id
IEEE String	planet.com	ICC000MEG0000	1

```
Switch# configure terminal
Switch (config)# mep 1 meg-id ICC000MEG0000 ieee name planet.com
```

4.2.140 mep <Instance> mep-id

Command:

```
mep <Instance> mep-id <mepid>
```

mep Maintenance Entity Point

<Instance> The MEP instance number.

mep-id The MEP-ID

<Mepid : uint> The MEP-ID value.

Default:

None

Usage Guide:

To configure **MEP-ID** of **MEP**.

Example:

To configure **MEP-ID** (5) of **MEP 1**.

```
Switch# configure terminal
Switch (config)# mep 1 mep-id 5
```

4.2.141 mep <Instance> peer-mep-id

Command:

```
mep <Instance> peer-mep-id <mepid> [ mac <mac> ]
```

- mep** Maintenance Entity Point
- <Instance>** The MEP instance number.
- peer-mep-id** The peer MEP-ID
- <Mepid : uint>** The peer MEP-ID value
- mac** The peer MAC. this will be overwritten by any learned MAC – through CCM reception.
- <Mac : mac_addr>** The peer MAC string

Default:

None

Usage Guide:

To configure **Peer MEP-ID** of **MEP**.

Example:

To configure **Peer MEP-ID** of **MEP 1** as below table

Peer MEP ID	Unicast Peer MAC
0	11-3A-05-A1-53-11

```
Switch# configure terminal
Switch (config)# mep 1 peer-mep-id 0 mac 11-3A-05-A1-53-11
```

4.2.142 mep <Instance> performance-monitoring

Command:

```
mep <Instance> performance-monitoring
```

- mep** Maintenance Entity Point
- <Instance>** The MEP instance number.
- performance-monitoring** Performance monitoring Data Set collection (MEF35)

Default:

Disabled

Usage Guide:

To enable **Performance Monitoring of MEP**.

Example:

To enable **Performance Monitoring of MEP 1**

```
Switch# configure terminal
Switch (config)# mep 1 performance-monitoring
```

4.2.143 mep <Instance> tst

Command:

```
mep <Instance> tst <prio> [ dei ] mep-id <mepid> [ sequence ] [ all-zero | all-one | one-zero ] rate <rate> size <size>
```

- mep** Maintenance Entity Point
- <Instance>** The MEP instance number.
- tst** Test Signal
- <Prio : 0-7>** Priority in case of tagged OAM. In the EVC domain this is the COS-ID.
- dei** Drop Eligible Indicator in case of tagged OAM.
- mep-id** Peer MEP-ID for unicast TST. The MAC is taken from peer MEP MAC database.
- <Mepid : uint>** Peer MEP-ID value
- sequence** Enable sequence number in TST PDU
- all-one** Test pattern is set to all one.
- all-zero** Test pattern is set to all zero.
- one-zero** Test pattern is set to 10101010.
- rate** The TST frame transmission bit rate - in Mega bits pr. second. Limit on Caracal is 400 Mbps. Limit on Serval is 1Gbps. This is the bit rate of a standard frame without any encapsulation. If 1 Mbps rate is selected in a EVC MEP, the added tag will give a hi
- <Rate : uint>** Transmission rate value
- size** The TST frame size. This is entered as the wanted size (in bytes) of a un-tagged frame containing TST OAM PDU - including CRC (four bytes). Example when 'Size' = 64 => Un-tagged frame size = DMAC(6) + SMAC(6) + TYPE(2) + TST PDU LENGTH(46) + CRC(4) = 64
- <Size : uint>** Frame size value

Default:

Dei	Priority	Peer MEP	Rate	Size	Pattern	Sequence Number
<input type="checkbox"/>	0	1	1	64	All Zero	<input type="checkbox"/>

Usage Guide:

To enable **Test Signal** of **MEP**.

Example:

To enable **Test Signal** of **MEP 1** as below table

Dei	Priority	Peer MEP	Rate	Size	Pattern	Sequence Number
<input checked="" type="checkbox"/>	3	2	10	68	10101010	<input checked="" type="checkbox"/>

```
Switch# configure terminal
Switch (config)# mep 1 tst 3 dei mep-id 2 sequence one-zero rate 10 size 68
```

4.2.144 mep <Instance> up

Command:

```
mep <Instance> [mip] up domain { port | evc | vlan } [ vid <vid> ] flow <flow> level
<level> interface <port_type> <port>
```

mep Maintenance Entity Point

<Instance> The MEP instance number.

mip This MEP instance is a half-MIP

up This MEP is a Up-MEP

domain The domain of the MEP

evc This MEP is a EVC domain MEP.

port This MEP is a Port domain MEP.

vlan This MEP is a VLAN domain MEP.

flow The flow instance that the MEP is related to.

<flow > The flow instance number when not in the port domain.

vid In case the MEP is a port Up-MEP or a EVC customer MIP the VID must be given.

<Vid : vlan_id> The port Domain MEP VID. This is required for a Port Up-MEP.

Default:

None

Usage Guide:

To configure **Up-MEP** of **MEP**.

Example:

To configure **Up-MEP** of **MEP 2** as below table

Instance	Domain	Mode	Direction	Residence Port	Level	Flow Instance	Tagged VID
2	Port	Mep	Up	1	2	1	1

```
Switch# configure terminal
Switch (config)# mep 2 up domain port vid 1 flow 1 level 2 interface GigabitEthernet
1/1
```

4.2.145 mep <Instance> vid

Command:

```
mep <Instance> vid <vid>
```

mep Maintenance Entity Point

<Instance> The MEP instance number.

vid The MEP VID

<Vid : vlan_id> The MEP VID value

Default:

0

Usage Guide:

To set **VID** of **MEP**.

Example:

To set **VID (8)** of **MEP 1**.

```
Switch# configure terminal
Switch (config)# mep 1 vid 8
```

4.2.146 mep <Instance> voe

Command:

```
mep <Instance> voe
```

mep Maintenance Entity Point

<Instance> The MEP instance number.

voe MEP is VOE based

Default:

0

Usage Guide:

To set **VOE** of **MEP**.

Example:

To set **VOE (8)** of **MEP 1**

```
Switch# configure terminal
Switch (config)# mep 1 voe
```

4.2.147 monitor destination

Command:

```
monitor destination interface 10GigabitEthernet <port_type_list> | GigabitEthernet
<port_type_list>
```

monitor Set monitor configuration

destination The destination port. That is the port that trafficed should be mirrored to

Default:

Disabled

Usage Guide:

To configure **Mirroring Port**

Example:

To set **Mirroring Port (GigabitEthernet 1/2)**

```
Switch# configure terminal
Switch (config)# monitor destination interface GigabitEthernet 1/2
```

4.2.148 monitor source

Command:

```
monitor source interface * | 10GigabitEthernet <port_type_list> | GigabitEthernet
<port_type_list> { both | rx | tx }
```

monitor Set monitor configuration

source The source port(s). That is the ports to be mirrored to the destination port.

Default:

Disabled

Usage Guide:

To configure **Mirrored Port**

Example:

To set **Mirrored Port (GigabitEthernet 1/1, Tx + Rx)**

```
Switch# configure terminal
```



```
Switch (config)# monitor source interface GigabitEthernet 1/1 both
```

4.2.149 mvr

Command:

```
mvr
```

mvr Multicast VLAN Registration configuration

Default:

Disabled

Usage Guide:

To enable **MVR**

Example:

To enable **MVR**

```
Switch# configure terminal
Switch (config)# mvr
```

4.2.150 mvr name <mvr_name> channel

Command:

```
mvr name <mvr_name> channel <ProfileName : word16>
```

mvr Multicast VLAN Registration configuration

name MVR multicast name

<MvrName : word16> MVR multicast VLAN name

channel MVR channel configuration

<ProfileName : word16> Profile name

Default:

None

Usage Guide:

To configure **channel interface** of **MVR profile**

Example:

To configure **channel interface (1)** of **MVR profile (123)**

```
Switch# configure terminal
Switch (config)# mvr name 123 channel 1
```

4.2.151 mvr name <mvr_name> frame priority

Command:

```
mvr name <mvr_name> frame priority <CosPriority : 0-7>
```

mvr Multicast VLAN Registration configuration
name MVR multicast name
<MvrName : word16> MVR multicast VLAN name
frame MVR control frame in TX
priority Interface CoS priority
<CosPriority : 0-7> CoS priority ranges from 0 to 7

Default:

0

Usage Guide:

To configure **frame priority** of **MVR profile**

Example:

To configure **frame priority (5)** of **MVR profile (123)**

```
Switch# configure terminal
Switch (config)# mvr name 123 frame priority 5
```

4.2.152 mvr name <mvr_name> frame tagged

Command:

```
mvr name <mvr_name> frame tagged
```

mvr Multicast VLAN Registration configuration
name MVR multicast name
<MvrName : word16> MVR multicast VLAN name
frame MVR control frame in TX
tagged Tagged IGMP/MLD frames will be sent

Default:

None

Usage Guide:

To configure **frame tagged** of **MVR profile**

Example:

To configure **frame tagged (frame tagged)** of **MVR profile (123)**

```
Switch# configure terminal
Switch (config)# mvr name 123 frame tagged
```

4.2.153 mvr name <mvr_name> igmp-address

Command:

```
mvr name <mvr_name> igmp-address <ipv4_ucast>
```

mvr Multicast VLAN Registration configuration
name MVR multicast name
<MvrName : word16> MVR multicast VLAN name
igmp-address MVR address configuration used in IGMP
<ipv4_ucast> A valid IPv4 unicast address

Default:

0.0.0.0

Usage Guide:

To configure the **MVR address** of **MVR profile**

Example:

To configure the **MVR address (192.168.0.55)** of **MVR profile (123)**

```
Switch# configure terminal
Switch (config)# mvr name 123 igmp-address 192.168.0.55
```

4.2.154 mvr name <mvr_name> last-member-query-interval

Command:

```
mvr name <mvr_name> last-member-query-interval <lpmcLmqi : 0-31744>
```

mvr Multicast VLAN Registration configuration
name MVR multicast name
<MvrName : word16> MVR multicast VLAN name
last-member-query-interval Last Member Query Interval in tenths of seconds
<lpmcLmqi : 0-31744> 0 - 31744 tenths of seconds

Default:

5

Usage Guide:To configure the **Last Member Query Interval** of **MVR profile****Example:**To configure the **Last Member Query Interval (50 seconds)** of **MVR profile (123)**

```
Switch# configure terminal
Switch (config)# mvr name 123 last-member-query-interval 500
```

4.2.155 mvr name <mvr_name> mode

Command:

```
mvr name <mvr_name> mode { compatible | dynamic }
```

mvr Multicast VLAN Registration configuration
name MVR multicast name
<MvrName : word16> MVR multicast VLAN name
mode MVR mode of operation
compatible Compatible MVR operation mode
dynamic Dynamic MVR operation mode

Default:

Dynamic

Usage Guide:To configure the **mode** of **MVR profile****Example:**To configure the **mode (compatible)** of **MVR profile (123)**

```
Switch# configure terminal
Switch (config)# mvr name 123 mode compatible
```

4.2.156 mvr vlan <vlan_list>

Command:

```
mvr vlan <vlan_list>
```

mvr Multicast VLAN Registration configuration

vlan MVR multicast vlan
<vlan_list> MVR multicast VLAN list

Default:

None

Usage Guide:

To create a profile of **MVR VLAN**

Example:

To create a profile of **MVR VLAN (5)**

```
Switch# configure terminal
Switch (config)# mvr vlan 5
```

4.2.157 mvr vlan <vlan_list> channel

Command:

```
mvr vlan <vlan_list> channel <ProfileName : word16>
```

mvr Multicast VLAN Registration configuration
vlan MVR multicast vlan
<vlan_list> MVR multicast VLAN list
channel MVR channel configuration
<ProfileName : word16> Profile name

Default:

0

Usage Guide:

To configure the **channel** of **MVR profile**

Example:

To configure the **channel (1)** of **MVR VLAN (5)**

```
Switch# configure terminal
Switch (config)# mvr vlan 5 channel 1
```

4.2.158 mvr vlan <vlan_list> frame priority

Command:

```
mvr vlan <vlan_list> frame priority <CosPriority : 0-7>
```

mvr Multicast VLAN Registration configuration

vlan MVR multicast vlan

<vlan_list> MVR multicast VLAN list

frame MVR control frame in TX

priority Interface CoS priority

<CosPriority : 0-7> CoS priority ranges from 0 to 7

Default:

0

Usage Guide:

To configure the **frame priority** of **MVR VLAN**

Example:

To configure the **frame priority (5)** of **MVR VLAN (123)**

```
Switch# configure terminal
Switch (config)# mvr vlan 123 frame priority 5
```

4.2.159 mvr vlan <vlan_list> tagged

Command:

```
mvr vlan <vlan_list> tagged
```

mvr Multicast VLAN Registration configuration

vlan MVR multicast vlan

<vlan_list> MVR multicast VLAN list

tagged Tagged IGMP/MLD frames will be sent

Default:

Enabled

Usage Guide:

To enable the **IGMP/MLD frame tagged** of **MVR VLAN**

Example:

To enable the **IGMP/MLD frame tagged** of **MVR VLAN (123)**

```
Switch# configure terminal
Switch (config)# mvr vlan 123 tagged
```

4.2.160 mvr vlan <vlan_list> igmp-address

Command:

```
mvr vlan <vlan_list> igmp-address <ipv4_ucast>
```

mvr Multicast VLAN Registration configuration
vlan MVR multicast vlan
<vlan_list> MVR multicast VLAN list
igmp-address MVR address configuration used in IGMP
<ipv4_ucast> A valid IPv4 unicast address

Default:

0.0.0.0

Usage Guide:

To configure the **MVR address** of **MVR VLAN**

Example:

To configure the **MVR address (192.168.0.55)** of **MVR VLAN (123)**

```
Switch# configure terminal
Switch (config)# mvr vlan 123 igmp-address 192.168.0.55
```

4.2.161 mvr vlan <vlan_list> last-member-query-interval

Command:

```
mvr vlan <vlan_list> last-member-query-interval <lpmcLmqi : 0-31744>
```

mvr Multicast VLAN Registration configuration
vlan MVR multicast vlan
<vlan_list> MVR multicast VLAN list
last-member-query-interval Last Member Query Interval in tenths of seconds
<lpmcLmqi : 0-31744> 0 - 31744 tenths of seconds

Default:

5

Usage Guide:

To configure the **Last Member Query Interval** of **MVR VLAN**

Example:

To configure the **Last Member Query Interval (50 seconds)** of **MVR VLAN (123)**

```
Switch# configure terminal
Switch (config)# mvr vlan 123 last-member-query-interval 500
```

4.2.162 mvr vlan <vlan_list> mode

Command:

```
mvr vlan <vlan_list> mode [ compatible | dynamic ]
```

mvr Multicast VLAN Registration configuration
vlan MVR multicast vlan
<vlan_list> MVR multicast VLAN list
mode MVR mode of operation
compatible Compatible MVR operation mode
dynamic Dynamic MVR operation mode

Default:

Dynamic

Usage Guide:

To configure the **mode** of **MVR VLAN**

Example:

To configure the **mode (compatible)** of **MVR VLAN (123)**

```
Switch# configure terminal
Switch (config)# mvr vlan 123 mode compatible
```

4.2.163 mvr vlan <vlan_list> name

Command:

```
mvr vlan <vlan_list> name
```

mvr Multicast VLAN Registration configuration
vlan MVR multicast vlan
<vlan_list> MVR multicast VLAN list
name MVR multicast name

Default:

None

Usage Guide:To configure profile name of **MVR VLAN****Example:**To configure profile name (6) of **MVR VLAN** (5)

```
Switch# configure terminal
Switch (config)# mvr vlan 5 name 6
```

4.2.164 network-clock clk-source <clk-source> aneg-mode

Command:

```
network-clock clk-source <clk-source> aneg-mode { master | slave | forced }
```

network-clock network-clock

clk-source clk-source - commands related to a specific clock source.

<clk-source : 1-2> Clock source number

aneg-mode Sets the preferred negotiation.

forced Activate forced slave negotiation

master Activate prefer master negotiation

slave Activate prefer slave negotiation

Default:

None

Usage Guide:To configure **preferred negotiation** of **network-clock****Example:**To configure **preferred negotiation** (slave) of **network-clock** (source 1)

```
Switch# configure terminal
Switch (config)# network-clock clk-source 1 aneg-mode slave
```

4.2.165 no

Command:

```
no
```

no Negate a command or set its defaults

Default:

N/A

Usage Guide:

To default the function

Example:

To disable the function (**loop-protect**)

```
Switch# configure terminal
Switch (config)# no loop-protect
```

4.2.166 ntp

Command:

```
ntp
```

ntp Configure NTP

Default:

Disabled

Usage Guide:

To enable the NTP service

Example:

To enable the NTP service

```
Switch# configure terminal
Switch (config)# ntp
```

4.2.167 ntp server

Command:

```
ntp server <1-5> ip-address { <ipv4_var> | <ipv6_var> | <name_var> }
```

ntp Configure NTP

server Configure NTP server

<1-5> index number

<hostname> domain name

<ipv4_ucast> ipv4 address

<ipv6_ucast> ipv6 address

Default:

None

Usage Guide:

To configure the **IP addresses** of **NTP Server**

Example:

To configure the **IP address** (9.9.9.9) of **NTP Server** for index 1

```
Switch# configure terminal
Switch (config)# ntp server 1 ip-address 9.9.9.9
```

4.2.168 poe admin-mode enable

Command:

```
poe admin-mode enable
```

poe Power Over Ethernet

admin-mode Enable or disable global PoE management function.

enable poe admin-mode enable

Default:

Enabled

Usage Guide:

To enable **System PoE Admin Mode**.

Example:

To enable **System PoE Admin Mode**.

```
Switch# configure terminal
Switch (config)# poe admin-mode enable
```

4.2.169 poe management mode

Command:

```
poe management mode { class-consumption | class-reserved-power |
allocation-consumption | allocation-reserved-power | lldp-consumption |
lldp-reserved-power }
```

poe Power Over Ethernet

- management** Use management mode to configure PoE power management method.
- mode** mode
- allocation-consumption** Max. port power determined by allocated, and power is managed according to power consumption.
- allocation-reserved-power** Max. port power determined by allocated, and is managed according to reserved power.
- class-consumption** Max. port power determined by class, and power is managed according to power consumption.
- class-reserved-power** Max. port power determined by class, and power managed according to reserved power.
- lldp-consumption** Max. port power determined by LLDP Media protocol, and power is managed according to consumption.
- lldp-reserved-power** Max. port power determined by LLDP Media protocol, and power is managed according to reserved power.

Default:

Allocation-consumption

Usage Guide:

To configure **PoE Management Mode**.

Example:

To configure **PoE Management Mode** as **LLDP-consumption mode**.

```
Switch# configure terminal
Switch (config)# poe management mode lldp-consumption
```

4.2.170 poe sequential enable

Command:

```
poe sequential enable
```

- poe** Power Over Ethernet
- sequential** PoE sequential is to delay power feeding when the switch is completely booted.
- enable** poe sequential enable

Default:

Enabled

Usage Guide:

To enable **Sequential Power up Option**.

Example:

To enable **Sequential Power up Option**.

```
Switch# configure terminal
```

```
Switch (config)# poe sequential enable
```

4.2.171 poe sequential interval

Command:

```
poe sequential interval <1-30>
```

poe Power Over Ethernet

sequential PoE sequential is to delay power feeding when the switch is completely booted.

interval Set how long system should feeding power to next PoE interface <1-30>

<1-30> poe sequential enable

Default:

5

Usage Guide:

To configure **Sequential Power up Interval**.

Example:

To configure **Sequential Power up Interval (30 seconds per port)**.

```
Switch# configure terminal
Switch (config)# poe sequential interval 30
```

4.2.172 poe sequential rule

Command:

```
poe sequential rule { port | priority }
```

poe Power Over Ethernet

sequential rule PoE sequential is to delay power feeding when the switch is completely booted.

port System sequential feeding power the PoE interfaces based port number.

priority Use priority command to configure sequential feeding power to PoE interfaces based on port PoE priority.

Default:

Port

Usage Guide:

To configure **Sequential Power up Port Option**.

Example:

To configure **Sequential Power up Port Option (Priority)**.

```
Switch# configure terminal
Switch (config)# poe sequential rule priority
```

4.2.173 poe supply

Command:

```
poe supply <1-XXX>
```

poe Power Over Ethernet

supply Use poe supply to specify the maximum power the power supply can deliver.

<1-XXX> Maximum power the power supply can deliver.

Default:

Maximum

Usage Guide:

To configure **Power Supply Budget**.

Example:

To configure **Power Supply Budget** (200 watts).

```
Switch# configure terminal
Switch (config)# poe supply 200
```

4.2.174 poe temperature-protection enable

Command:

```
poe temperature-protection enable
```

poe Power Over Ethernet

temperature-protection Configure PoE over temperature protection to enable or disable.

enable poe temperature-protection enable

Default:

Enabled

Usage Guide:

To enable **PoE Temperature Protection**.

Example:

To enable **PoE Temperature Protection**.

```
Switch# configure terminal
Switch (config)# poe temperature-protection enable
```

4.2.175 poe temperature-threshold

Command:

```
poe temperature-threshold <0-100>
```

poe Power Over Ethernet

temperature-threshold Set a lower high temperature threshold for the secondary temperature alarm in degrees C.

<0-100> Specifies the new threshold temperature.

Default:

80

Usage Guide:

To enable **PoE Temperature Protection**.

Example:

To enable **PoE Temperature Protection** (70 degrees C).

```
Switch# configure terminal
Switch (config)# poe temperature-threshold 70
```

4.2.176 poe usage-threshold

Command:

```
poe usage-threshold <1-99>
```

poe Power Over Ethernet

usage-threshold The poe usage-threshold command sets a percentage threshold above which the system sends a log or SNMP trap.<1-99>: The -threshold percentage configured with this command.

<1-99> The usage-threshold percentage configured with this command.

Default:

85

Usage Guide:

To configure **PoE Usage Threshold**.

Example:

To configure **PoE Usage Threshold (90 %)**.

```
Switch# configure terminal
Switch (config)# poe usage-threshold 90
```

4.2.177 poe-time-range

Command:

```
poe-time-range {profile1 | profile2 | profile3 | profile4}
```

poe-time-range Used to create PoE time-range for the switch and enter Power Time-range Create Configuration Mode.

profile1 The PoE time-range profile name, ranging from Profile 1

profile2 The PoE time-range profile name, ranging from Profile 2

profile3 The PoE time-range profile name, ranging from Profile 3

profile4 The PoE time-range profile name, ranging from Profile 4

Default:

N/A

Usage Guide:

To enter PoE time-range profile mode.

Example:

To enter PoE time-range profile 1 mode

```
Switch# configure terminal
Switch (config)# poe-time-range profile1
Switch (config-poe-time-range)#
```

4.2.177.1 do

Command:

```
do < exec commands >
```

do To run exec commands

Default:

N/A

Usage Guide:

To run **exec commands**

Example:

To run "show aaa".

```
Switch# configure terminal
Switch (config)# poe-time-range profile1
Switch (config-poe-time-range)#do show aaa
console : local
telnet  : local
ssh    : local
http   : local
```

4.2.177.2 end

Command:

```
end
```

end Go back to EXEC mode

Default:

Auto

Usage Guide:

To back to **EXEC mode**

Example:

To back to **EXEC mode**

```
Switch# configure terminal
Switch (config)# poe-time-range profile1
Switch (config-poe-time-range)#end
Switch#
```

4.2.177.3 exit

Command:

```
exit
```

exit Exit from current mode

Default:

None

Usage Guide:

To exit current mode

Example:

To exit current mode.

```
Switch# configure terminal
Switch (config)# poe-time-range profile1
Switch (config-poe-time-range)#exit
Switch (config)#
```

4.2.177.4 no

Command:

```
no
```

no Negate a command or set its defaults

Default:

N/A

Usage Guide:

To default the function.

Example:

To enable the function (**description 999**).

```
Switch# configure terminal
Switch (config)# poe-time-range profile1
Switch (config-poe-time-range)#no description 999
```

4.2.177.5 periodic

Command:

```
periodic { Mon | Tue | Wed | Thu | Fri | Sat | Sun } <start_h> <start_m> to <end_h>
<end_m> [ reboot <reboot_h> <reboot_m> ]
```

periodic To create a periodic mode time-range for the PoE time-range of the switch.

Fri Periodic Mode, with Friday.

Mon Periodic Mode, with Monday.

Sat Periodic Mode, with Saturday.

Sun Periodic Mode, with Sunday.

Thu Periodic Mode, with Thursday.

Tue Periodic Mode, with Tuesday.

Wed Periodic Mode, with Wednesday.

- < start_h: 0-23> <0-23> start hour
- < start_m: 0-59> <0-59> start minute
- to start to end
- < end_h: 0-23> <0-23> end hour
- < end_m: 0-59> <0-59> end minute
- reboot Enable reboot function
- < reboot_h: 0-23> <0-23> reboot hour
- < reboot_m:0-59> <0-59> reboot minute

Default:

N/A

Usage Guide:

To configure the **Power Over Ethernet Schedule** for specific profile.

Example:

To configure the **Power Over Ethernet Schedule** (below table) for specific profile 1.

Week Day	Start Hour	Start Min	End Hour	End Min	Reboot Enable	Reboot Only	Reboot Hour	Reboot Min
Mon	11	59	22	50	<input checked="" type="checkbox"/>	<input type="checkbox"/>	11	44

```
Switch# configure terminal
Switch (config)# poe-time-range profile1
Switch (config-poe-time-range)# periodic Mon 11 59 to 22 50 reboot 11 44
```

4.2.177.6 reboot-only

Command:

```
reboot-only { Mon | Tue | Wed | Thu | Fri | Sat | Sun } <reboot_h> <reboot_m>
```

reboot-only To create a periodic mode time-range for the PoE time-range of the switch.

Fri Periodic Mode, with Friday.

Mon Periodic Mode, with Monday.

Sat Periodic Mode, with Saturday.

Sun Periodic Mode, with Sunday.

Thu Periodic Mode, with Thursday.

Tue Periodic Mode, with Tuesday.

Wed Periodic Mode, with Wednesday.

< reboot_h: 0-23> <0-23> reboot hour

< reboot_m:0-59> <0-59> reboot minute

Default:

N/A

Usage Guide:

To configure the **Power Over Ethernet Reboot Schedule** for specific profile.

Example:

To configure the **Power Over Ethernet Reboot Schedule** (below table) for specific profile.

Week Day	Start Hour	Start Min	End Hour	End Min	Reboot Enable	Reboot Only	Reboot Hour	Reboot Min
Mon	00	0	00	0	<input checked="" type="checkbox"/>	<input checked="" type="checkbox"/>	00	0

```
Switch# configure terminal
Switch (config)# poe-time-range profile1
Switch (config-poe-time-range)# reboot Mon 0 0
```

4.2.178 port-security

Command:

```
port-security
```

port-security Enable/disable port security globally

Default:

Disabled

Usage Guide:

To enable the **Port Security**

Example:

To enable the **Port Security**

```
Switch# configure terminal
Switch (config)# port-security
```

4.2.179 port-security aging

Command:

```
port-security aging
```

port-security Enable/disable port security globally

aging Enable/disable port security aging

Default:

Disabled

Usage Guide:To enable the **Port Aging****Example:**To enable the **Port Aging**

```
Switch# configure terminal
Switch (config)# port-security port-security aging
```

4.2.180 port-security aging time

Command:

```
port-security aging time <10-10000000>
```

port-security Enable/disable port security globally**aging** Enable/disable port security aging**time** Time in seconds between check for activity on learned MAC addresses**<10-10000000>** seconds**Default:**

3600

Usage Guide:To configure the **Aging Period of Port Security****Example:**To configure the **Aging Period (159) of Port Security**

```
Switch# configure terminal
Switch (config)# port-security aging time 159
```

4.2.181 privilege

Command:

```
privilege { exec | configure | config-vlan | line | interface | if-vlan | ipmc-profile |
snmps-host | stp-aggr | dhcp-pool | rfc2544-profile } level <privilege> <cmd>
```

privilege Command privilege parameters**config-vlan** VLAN Configuration Mode**configure** Global configuration mode

dhcp-pool	DHCP Pool Configuration Mode
exec	Exec mode
if-vlan	VLAN Interface Mode
interface	Port List Interface Mode
ipmc-profile	IPMC Profile Mode
line	Line configuration mode
rfc2544-profile	RFC2544 Profile Mode
snmps-host	SNMP Server Host Mode
stp-aggr	STP Aggregation Mode
level	Set privilege level of command
<0-15>	Privilege level
<cmd>	Initial valid words and literals of the command to modify

Default:

None

Usage Guide:

To configure the **Privilege Level** for **Command Line**

Example:

To configure the **Privilege Level** (DHCP Pool mode, Level 12, Command: host) for **Command Line**

```
Switch# configure terminal
Switch (config)# privilege dhcp-pool level 12 host
```

4.2.182 qos map cos-dscp

Command:

```
qos map cos-dscp <cos> dpl <dpl> dscp { <dscp_num> | { be | af11 | af12 | af13 | af21 | af22 | af23 | af31 | af32 | af33 | af41 | af42 | af43 | cs1 | cs2 | cs3 | cs4 | cs5 | cs6 | cs7 | ef | va } }
```

qos	Quality of Service
map	Global QoS Map/Table
cos-dscp	Map for cos to dscp
<Cos : 0-7>	Specific class of service or range
dscp	Specify DSCP
<DscpNum : 0-63>	Specific DSCP
af11	Assured Forwarding PHB AF11(DSCP 10)
af12	Assured Forwarding PHB AF12(DSCP 12)
af13	Assured Forwarding PHB AF13(DSCP 14)

af21	Assured Forwarding PHB AF21(DSCP 18)
af22	Assured Forwarding PHB AF22(DSCP 20)
af23	Assured Forwarding PHB AF23(DSCP 22)
af31	Assured Forwarding PHB AF31(DSCP 26)
af32	Assured Forwarding PHB AF32(DSCP 28)
af33	Assured Forwarding PHB AF33(DSCP 30)
af41	Assured Forwarding PHB AF41(DSCP 34)
af42	Assured Forwarding PHB AF42(DSCP 36)
af43	Assured Forwarding PHB AF43(DSCP 38)
be	Default PHB(DSCP 0) for best effort traffic
cs1	Class Selector PHB CS1 precedence 1(DSCP 8)
cs2	Class Selector PHB CS2 precedence 2(DSCP 16)
cs3	Class Selector PHB CS3 precedence 3(DSCP 24)
cs4	Class Selector PHB CS4 precedence 4(DSCP 32)
cs5	Class Selector PHB CS5 precedence 5(DSCP 40)
cs6	Class Selector PHB CS6 precedence 6(DSCP 48)
cs7	Class Selector PHB CS7 precedence 7(DSCP 56)
ef	Expedited Forwarding PHB(DSCP 46)
va	Voice Admit PHB(DSCP 44)

Default:

0

Usage Guide:

To configure the **DSCP Classification**

Example:

To configure the **DSCP Classification (QoS Class 3: DSCP CS1)**

```
Switch# configure terminal
Switch (config)# qos map cos-dscp 3 dscp cs1
```

4.2.183 qos map dscp-classify

Command:

```
qos map dscp-classify { <dscp_num> | { be | af11 | af12 | af13 | af21 | af22 | af23 | af31 | af32 | af33 | af41 | af42 | af43 | cs1 | cs2 | cs3 | cs4 | cs5 | cs6 | cs7 | ef | va } }
```

- qos** Quality of Service
- map** Global QoS Map/Table
- dscp-classify** Map for dscp classify enable
- <DscpNum : 0-63>** Specific DSCP
- af11** Assured Forwarding PHB AF11(DSCP 10)

af12	Assured Forwarding PHB AF12(DSCP 12)
af13	Assured Forwarding PHB AF13(DSCP 14)
af21	Assured Forwarding PHB AF21(DSCP 18)
af22	Assured Forwarding PHB AF22(DSCP 20)
af23	Assured Forwarding PHB AF23(DSCP 22)
af31	Assured Forwarding PHB AF31(DSCP 26)
af32	Assured Forwarding PHB AF32(DSCP 28)
af33	Assured Forwarding PHB AF33(DSCP 30)
af41	Assured Forwarding PHB AF41(DSCP 34)
af42	Assured Forwarding PHB AF42(DSCP 36)
af43	Assured Forwarding PHB AF43(DSCP 38)
be	Default PHB(DSCP 0) for best effort traffic
cs1	Class Selector PHB CS1 precedence 1(DSCP 8)
cs2	Class Selector PHB CS2 precedence 2(DSCP 16)
cs3	Class Selector PHB CS3 precedence 3(DSCP 24)
cs4	Class Selector PHB CS4 precedence 4(DSCP 32)
cs5	Class Selector PHB CS5 precedence 5(DSCP 40)
cs6	Class Selector PHB CS6 precedence 6(DSCP 48)
cs7	Class Selector PHB CS7 precedence 7(DSCP 56)
ef	Expedited Forwarding PHB(DSCP 46)
va	Voice Admit PHB(DSCP 44)

Default:

Disabled

Usage Guide:

To enabled the **DSCP Ingress Classification**

Example:

To configure the **DSCP Ingress Classification (DSCP 36)**

```
Switch# configure terminal
Switch (config)# qos map dscp-classify af42
```

4.2.184 qos map dscp-cos

Command:

```
qos map dscp-cos { <dscp_num> | { be | af11 | af12 | af13 | af21 | af22 | af23 | af31 |
af32 | af33 | af41 | af42 | af43 | cs1 | cs2 | cs3 | cs4 | cs5 | cs6 | cs7 | ef | va } } cos
<cos> dpl <dpl>
```

qos Quality of Service

- map** Global QoS Map/Table
- dscp-cos** Map for dscp to cos
- <DscpNum : 0-63>** Specific DSCP
- af11** Assured Forwarding PHB AF11(DSCP 10)
- af12** Assured Forwarding PHB AF12(DSCP 12)
- af13** Assured Forwarding PHB AF13(DSCP 14)
- af21** Assured Forwarding PHB AF21(DSCP 18)
- af22** Assured Forwarding PHB AF22(DSCP 20)
- af23** Assured Forwarding PHB AF23(DSCP 22)
- af31** Assured Forwarding PHB AF31(DSCP 26)
- af32** Assured Forwarding PHB AF32(DSCP 28)
- af33** Assured Forwarding PHB AF33(DSCP 30)
- af41** Assured Forwarding PHB AF41(DSCP 34)
- af42** Assured Forwarding PHB AF42(DSCP 36)
- af43** Assured Forwarding PHB AF43(DSCP 38)
- be** Default PHB(DSCP 0) for best effort traffic
- cs1** Class Selector PHB CS1 precedence 1(DSCP 8)
- cs2** Class Selector PHB CS2 precedence 2(DSCP 16)
- cs3** Class Selector PHB CS3 precedence 3(DSCP 24)
- cs4** Class Selector PHB CS4 precedence 4(DSCP 32)
- cs5** Class Selector PHB CS5 precedence 5(DSCP 40)
- cs6** Class Selector PHB CS6 precedence 6(DSCP 48)
- cs7** Class Selector PHB CS7 precedence 7(DSCP 56)
- ef** Expedited Forwarding PHB(DSCP 46)
- va** Voice Admit PHB(DSCP 44)
- cos** Specify class of service
- <Cos : 0-7>** Specific class of service
- dpl** Specify drop precedence level
- <Dpl : dpl>** Specific drop precedence level

Default:

0

Usage Guide:

To configure the **DSCP-Based QoS Ingress Classification**

Example:

To configure the **DSCP-Based QoS Ingress Classification (DSCP: 44, QoS Class: 6, DPL: 2)**

```
Switch# configure terminal
Switch (config)# qos map dscp-cos va cos 6 dpl 2
```

4.2.185 qos map dscp-egress-translation

Command:

```
qos map dscp-egress-translation { <dscp_num> | { be | af11 | af12 | af13 | af21 | af22 |
af23 | af31 | af32 | af33 | af41 | af42 | af43 | cs1 | cs2 | cs3 | cs4 | cs5 | cs6 | cs7 | ef |
va } } to { <dscp_num_tr> | { be | af11 | af12 | af13 | af21 | af22 | af23 | af31 | af32 | af33
| af41 | af42 | af43 | cs1 | cs2 | cs3 | cs4 | cs5 | cs6 | cs7 | ef | va } }
```

qos	Quality of Service
map	Global QoS Map/Table
dscp-egress-translation	Map for dscp egress translation
<DscpNum : 0-63>	Specific DSCP
af11	Assured Forwarding PHB AF11(DSCP 10)
af12	Assured Forwarding PHB AF12(DSCP 12)
af13	Assured Forwarding PHB AF13(DSCP 14)
af21	Assured Forwarding PHB AF21(DSCP 18)
af22	Assured Forwarding PHB AF22(DSCP 20)
af23	Assured Forwarding PHB AF23(DSCP 22)
af31	Assured Forwarding PHB AF31(DSCP 26)
af32	Assured Forwarding PHB AF32(DSCP 28)
af33	Assured Forwarding PHB AF33(DSCP 30)
af41	Assured Forwarding PHB AF41(DSCP 34)
af42	Assured Forwarding PHB AF42(DSCP 36)
af43	Assured Forwarding PHB AF43(DSCP 38)
be	Default PHB(DSCP 0) for best effort traffic
cs1	Class Selector PHB CS1 precedence 1(DSCP 8)
cs2	Class Selector PHB CS2 precedence 2(DSCP 16)
cs3	Class Selector PHB CS3 precedence 3(DSCP 24)
cs4	Class Selector PHB CS4 precedence 4(DSCP 32)
cs5	Class Selector PHB CS5 precedence 5(DSCP 40)
cs6	Class Selector PHB CS6 precedence 6(DSCP 48)
cs7	Class Selector PHB CS7 precedence 7(DSCP 56)
ef	Expedited Forwarding PHB(DSCP 46)
va	Voice Admit PHB(DSCP 44)

Default:

None

Usage Guide:

To configure the **DSCP Egress Translation**

Example:

To configure the **DSCP Egress Translation (AF11 to AF12)**

```
Switch# configure terminal
Switch (config)# qos map dscp-egress-translation af11 to af12
```

4.2.186 qos map dscp-ingress-translation

Command:

```
qos map dscp-ingress-translation { <dscp_num> | { be | af11 | af12 | af13 | af21 | af22
| af23 | af31 | af32 | af33 | af41 | af42 | af43 | cs1 | cs2 | cs3 | cs4 | cs5 | cs6 | cs7 | ef |
va } } to { <dscp_num_tr> | { be | af11 | af12 | af13 | af21 | af22 | af23 | af31 | af32 | af33
| af41 | af42 | af43 | cs1 | cs2 | cs3 | cs4 | cs5 | cs6 | cs7 | ef | va } }
```

- qos** Quality of Service
- map** Global QoS Map/Table
- dscp-ingress-translation** Map for dscp ingress translation
- <DscpNum : 0-63>** Specific DSCP
- af11** Assured Forwarding PHB AF11(DSCP 10)
- af12** Assured Forwarding PHB AF12(DSCP 12)
- af13** Assured Forwarding PHB AF13(DSCP 14)
- af21** Assured Forwarding PHB AF21(DSCP 18)
- af22** Assured Forwarding PHB AF22(DSCP 20)
- af23** Assured Forwarding PHB AF23(DSCP 22)
- af31** Assured Forwarding PHB AF31(DSCP 26)
- af32** Assured Forwarding PHB AF32(DSCP 28)
- af33** Assured Forwarding PHB AF33(DSCP 30)
- af41** Assured Forwarding PHB AF41(DSCP 34)
- af42** Assured Forwarding PHB AF42(DSCP 36)
- af43** Assured Forwarding PHB AF43(DSCP 38)
- be** Default PHB(DSCP 0) for best effort traffic
- cs1** Class Selector PHB CS1 precedence 1(DSCP 8)
- cs2** Class Selector PHB CS2 precedence 2(DSCP 16)
- cs3** Class Selector PHB CS3 precedence 3(DSCP 24)
- cs4** Class Selector PHB CS4 precedence 4(DSCP 32)
- cs5** Class Selector PHB CS5 precedence 5(DSCP 40)
- cs6** Class Selector PHB CS6 precedence 6(DSCP 48)
- cs7** Class Selector PHB CS7 precedence 7(DSCP 56)
- ef** Expedited Forwarding PHB(DSCP 46)

va Voice Admit PHB(DSCP 44)

Default:

None

Usage Guide:

To configure the **DSCP Ingress Translation**

Example:

To configure the **DSCP Ingress Translation (AF11 to AF12)**

```
Switch# configure terminal
Switch (config)# qos map dscp-ingress-translation af11 to af12
```

4.2.187 qos qce

Command:

```
qos qce <qce_id> [ { next <qce_id_next> } | last ] [ interface ( <port_type>
[ <port_list> ] ) ] [ smac { <smac> | <smac_24> | any } ] [ dmac { <dmac> | unicast |
multicast | broadcast | any } ] [ tag { [ type { untagged | tagged | c-tagged | s-tagged |
any } ] [ vid { <ot_vid> | any } ] [ pcp { <ot_pcp> | any } ] [ dei { <ot_dei> | any } ] } ]
[ inner-tag { [ type { untagged | tagged | c-tagged | s-tagged | any } ] [ vid { <it_vid> |
any } ] [ pcp { <it_pcp> | any } ] [ dei { <it_dei> | any } ] } ] [ frame-type { any | { etype
[ { <etype_type> | any } ] } | llc [ dsap { <llc_dsap> | any } ] [ ssap { <llc_ssap> |
any } ] [ control { <llc_control> | any } ] } | { snap [ { <snap_data> | any } ] } | { ipv4
[ proto { <pr4> | tcp | udp | any } ] [ sip { <sip4> | any } ] [ dip { <dip4> | any } ] [ dscp
{ <dscp4> | { be | af11 | af12 | af13 | af21 | af22 | af23 | af31 | af32 | af33 | af41 | af42 |
af43 | cs1 | cs2 | cs3 | cs4 | cs5 | cs6 | cs7 | ef | va } | any } ] [ fragment { yes | no |
any } ] [ sport { <sp4> | any } ] [ dport { <dp4> | any } ] } | { ipv6 [ proto { <pr6> | tcp |
udp | any } ] [ sip { <sip6> | any } ] [ dip { <dip6> | any } ] [ dscp { <dscp6> | { be | af11
| af12 | af13 | af21 | af22 | af23 | af31 | af32 | af33 | af41 | af42 | af43 | cs1 | cs2 | cs3 |
cs4 | cs5 | cs6 | cs7 | ef | va } | any } ] [ sport { <sp6> | any } ] [ dport { <dp6> |
any } ] } ] } ] [ action { [ cos { <action_cos> | default } ] [ dpl { <action_dpl> | default } ]
[ pcp-dei { <action_pcp> <action_dei> | default } ] [ dscp { <action_dscp_dscp> | { be
| af11 | af12 | af13 | af21 | af22 | af23 | af31 | af32 | af33 | af41 | af42 | af43 | cs1 | cs2 |
cs3 | cs4 | cs5 | cs6 | cs7 | ef | va } | default } ] [ policy { <action_policy> | default } ] } ] }
```

qos Quality of Service

qce QoS Control Entry

action Setup action

dmac Setup matched DMAC

frame-type Setup matched frame type

- interface** Interfaces
- last** Place QCE at the end
- next** Place QCE before the next QCE ID
- smac** Setup matched SMAC
- tag** Setup tag options

Default:

None

Usage Guide:

To configure the **QCE**

Example:

To configure the **QCE 1** (below table) for interface **GigabitEthernet 1/1-2**

Key Parameters		Action Parameters	
DMAC	Unicast <input type="button" value="v"/>	CoS	0 <input type="button" value="v"/>
SMAC	Any <input type="button" value="v"/>	DPL	1 <input type="button" value="v"/>
Tag	Tagged <input type="button" value="v"/>	DSCP	4 <input type="button" value="v"/>
VID	Specific <input type="button" value="v"/> Value: 5 <input type="text"/>	UDP Parameters	
PCP	3 <input type="button" value="v"/>	Sport	Specific <input type="button" value="v"/> Value: 55 <input type="text"/>
DEI	1 <input type="button" value="v"/>	Dport	Any <input type="button" value="v"/>
Frame Type	IPv4 <input type="button" value="v"/>		
IPv4 Parameters			
Protocol	UDP <input type="button" value="v"/>		
SIP	Any <input type="button" value="v"/>		
IP Fragment	No <input type="button" value="v"/>		
DSCP	Specific <input type="button" value="v"/> 19 <input type="text"/>		

```
Switch# configure terminal
Switch (config)# qos qce 1 interface GigabitEthernet 1/1-2 tag type tagged vid 5 pcp 3
dei 1 dmac unicast frame-type ipv4 proto udp dscp 19 frag no sport 55 action cos 0
dpl 1 dscp 4
```

4.2.188 qos qce update

Command:

```
qos qce update <qce_id> [ { next <qce_id_next> } | last ] [ interface ( <port_type>
[ <port_list> ] ) ] [ smac { <smac> | <smac_24> | any } ] [ dmac { <dmac> | unicast |
multicast | broadcast | any } ] [ tag { [ type { untagged | tagged | c-tagged | s-tagged |
any } ] [ vid { <ot_vid> | any } ] [ pcp { <ot_pcp> | any } ] [ dei { <ot_dei> | any } ] ] ]
```

```
[ inner-tag { [ type { untagged | tagged | c-tagged | s-tagged | any } ] [ vid { <it_vid> |
any } ] [ pcp { <it_pcp> | any } ] [ dei { <it_dei> | any } ] } ] [ frame-type { any | { etype
[ { <etype_type> | any } ] } | { llc [ dsap { <llc_dsap> | any } ] [ ssap { <llc_ssap> |
any } ] [ control { <llc_control> | any } ] } | { snap [ { <snap_data> | any } ] } | { ipv4
[ proto { <pr4> | tcp | udp | any } ] [ sip { <sip4> | any } ] [ dip { <dip4> | any } ] [ dscp
{ <dscp4> | { be | af11 | af12 | af13 | af21 | af22 | af23 | af31 | af32 | af33 | af41 | af42 |
af43 | cs1 | cs2 | cs3 | cs4 | cs5 | cs6 | cs7 | ef | va } | any } ] [ fragment { yes | no |
any } ] [ sport { <sp4> | any } ] [ dport { <dp4> | any } ] } | { ipv6 [ proto { <pr6> | tcp |
udp | any } ] [ sip { <sip6> | any } ] [ dip { <dip6> | any } ] [ dscp { <dscp6> | { be | af11
| af12 | af13 | af21 | af22 | af23 | af31 | af32 | af33 | af41 | af42 | af43 | cs1 | cs2 | cs3 |
cs4 | cs5 | cs6 | cs7 | ef | va } | any } ] [ sport { <sp6> | any } ] [ dport { <dp6> |
any } ] } } ] [ action { [ cos { <action_cos> | default } ] [ dpl { <action_dpl> | default } ]
[ pcp-dei { <action_pcp> <action_dei> | default } ] [ dscp { <action_dscp_dscp> | { be
| af11 | af12 | af13 | af21 | af22 | af23 | af31 | af32 | af33 | af41 | af42 | af43 | cs1 | cs2 |
cs3 | cs4 | cs5 | cs6 | cs7 | ef | va } | default } ] [ policy { <action_policy> | default } ] } ]
```

- qos** Quality of Service
- qce** QoS Control Entry
- update** Update an existing QCE
- action** Setup action
- dmac** Setup matched DMAC
- frame-type** Setup matched frame type
- interface** Interfaces
- last** Place QCE at the end
- next** Place QCE before the next QCE ID
- smac** Setup matched SMAC
- tag** Setup tag options

Default:

None

Usage Guide:

To update the **QCE**

Example:

To update the **QCE 1 (DMAC: Unicast, Action: Cos 0)**.

```
Switch# configure terminal
Switch (config)# qos qce update 1 dmac unicast action cos 0
```

4.2.189 qos qce refresh

Command:

```
qos qce refresh
```

qos Quality of Service
qce QoS Control Entry
refresh Refresh QCE tables in hardware

Default:

None

Usage Guide:

To refresh the **QCE**

Example:

To refresh the **QCE**.

```
Switch# configure terminal
Switch (config)# qos qce refresh
```

4.2.190 qos wred

Command:

```
qos wred queue <queue> min-th <min_th> mdp-1 <mdp_1> mdp-2 <mdp_2> mdp-3
<mdp_3>
```

qos Quality of Service
wred Weighted Random Early Discard
queue Specify queue
<Queue : 0~5> Specific queue or range
min-th Specify minimum threshold
<MinTh : 0-100> Specific minimum threshold in percent
mdp-1 Specify drop probability for drop precedence level 1
<Mdp1 : 0-100> Specific drop probability in percent
mdp-2 Specify drop probability for drop precedence level 2
<Mdp2 : 0-100> Specific drop probability in percent
mdp-3 Specify drop probability for drop precedence level 3

<Mdp3 : 0-100> Specific drop probability in percent

Default:

Queue	Enable	Min. Threshold	Max. DP 1	Max. DP 2	Max. DP 3
0	<input type="checkbox"/>	0	1	5	10
1	<input checked="" type="checkbox"/>	2	3	4	5
2	<input type="checkbox"/>	0	1	5	10
3	<input type="checkbox"/>	0	1	5	10
4	<input type="checkbox"/>	0	1	5	10
5	<input type="checkbox"/>	0	1	5	10

Usage Guide:

To configure the **Weighted Random Early Detection**

Example:

To configure the **Weighted Random Early Detection** (below table)

Queue	Enable	Min. Threshold	Max. DP 1	Max. DP 2	Max. DP 3
0	<input type="checkbox"/>	0	1	5	10
1	<input type="checkbox"/>	0	1	5	10
2	<input type="checkbox"/>	0	1	5	10
3	<input type="checkbox"/>	0	1	5	10
4	<input type="checkbox"/>	0	1	5	10
5	<input type="checkbox"/>	0	1	5	10

```
Switch# configure terminal
```

```
Switch (config)# qos wred queue 1 min-th 2 mdp-1 3 mdp-2 4 mdp-3 5
```

4.2.191 radius-server attribute 32

Command:

```
radius-server attribute 32 <Id : line1-253>
```

radius-server Configure RADIUS

32 NAS-Identifier

Default:

None

Usage Guide:

To configure the **NAS-Identifier**

Example:

To configure the **NAS-Identifier** (planet)

```
Switch# configure terminal
Switch (config)# radius-server attribute 32 planet
```

4.2.192 radius-server attribute 4

Command:

```
radius-server attribute 4 <ipv4 : ipv4_ucast>
```

radius-server Configure RADIUS
4 NAS-IP-Address

Default:

None

Usage Guide:

To configure the **NAS-IP-Address**

Example:

To configure the **NAS-IP-Address** (7.7.7.7)

```
Switch# configure terminal
Switch (config)# radius-server attribute 4 7.7.7.7
```

4.2.193 radius-server attribute 95

Command:

```
radius-server attribute 95 <ipv6 : ipv6_ucast>
```

radius-server Configure RADIUS
95 NAS-IPv6-Address

Default:

None

Usage Guide:

To configure the **NAS-IPv6-Address**

Example:

To configure the **NAS-IPv6-Address** (2001::7788)

```
Switch# configure terminal
Switch (config)# radius-server attribute 95 2001::7788
```

4.2.194 radius-server deadtime

Command:

```
radius-server deadtime <Minutes : 1-1440>
```

radius-server Configure RADIUS

deadtime Time to stop using a RADIUS server that doesn't respond

<Minutes : 1-1440> Time in minutes

Default:

0

Usage Guide:

To configure the **Deadtime** of **Radius-Server**

Example:

To configure the **Deadtime** (15) of **Radius-Server**

```
Switch# configure terminal
Switch (config)# radius-server deadtime 15
```

4.2.195 radius-server host

Command:

```
radius-server host <host_name> [ auth-port <auth_port> ] [ acct-port <acct_port> ]
[ timeout <seconds> ] [ retransmit <retries> ] [ key <key> ]
```

radius-server Configure RADIUS

host Specify a RADIUS server

<HostName : word1-255> Hostname or IP address

acct-port UDP port for RADIUS accounting server

<AcctPort : 0-65535> UDP port number

auth-port UDP port for RADIUS authentication server

<AuthPort : 0-65535> UDP port number

key Server specific key (overrides default)

<Key : line1-63> The shared key

retransmit Specify the number of retries to active server (overrides default)

<Retries : 1-1000> Number of retries for a transaction

timeout Time to wait for this RADIUS server to reply (overrides default)

<Seconds : 1-1000> Wait time in seconds

Default:

None

Usage Guide:To configure the **Host** of **Radius-Server****Example:**To configure the **Host** (below table) of **Radius-Server**

Hostname	Auth Port	Acct Port	Timeout	Retransmit	Key
planet.com.tw	1812	1813	10	6	123456789

Switch# configure terminal

Switch (config)# **radius-server host planet.com.tw timeout 10 retransmit 6 key 123456789**

4.2.196 radius-server key

Command:

```
radius-server key <Key : line1-63>
```

radius-server Configure RADIUS**key** Set RADIUS encryption key**<Key : line1-63>** The shared key**Default:**

None

Usage Guide:To configure the **Key** of **Radius-Server****Example:**To configure the **Key** (123456789) of **Radius-Server**

Switch# configure terminal

Switch (config)# **radius radius-server key 123456789**

4.2.197 radius-server retransmit

Command:

```
radius-server retransmit <Retries : 1-1000>
```

radius-server Configure RADIUS
retransmit Specify the number of retries to active server
<Retries : 1-1000> Number of retries for a transaction

Default:

3

Usage Guide:

To configure the retransmitted time of **Radius-Server**

Example:

To configure the retransmitted time (5) of **Radius-Server**

```
Switch# configure terminal
Switch (config)# radius-server retransmit 5
```

4.2.198 radius-server timeout

Command:

```
radius-server timeout <Seconds : 1-1000>
```

radius-server Configure RADIUS
timeout Time to wait for a RADIUS server to reply
<Seconds : 1-1000> Wait time in seconds

Default:

5

Usage Guide:

To configure the **timeout** of **Radius-Server**

Example:

To configure the **timeout** (10) of **Radius-Server**

```
Switch# configure terminal
Switch (config)# radius-server timeout 10
```

4.2.199 rmon alarm

Command:

```
rmon alarm <id> {<oid_str> | {{ ifInOctets | ifInUcastPkts | ifInNUcastPkts |
ifInDiscards | ifInErrors | ifInUnknownProtos | ifOutOctets | ifOutUcastPkts |
ifOutNUcastPkts | ifOutDiscards | ifOutErrors } <ifIndex>}} <interval: 1-2147483647>
{ absolute | delta } rising-threshold <rising_threshold: -2147483648-2147483647>
[<rising_event_id: 0-65535>] falling-threshold <falling_threshold:
-2147483648-2147483647> [ <falling_event_id: 0-65535> ] { [ rising | falling |
both ] }
```

rmon Remote Monitoring

alarm Configure an RMON alarm

<oid_str> MIB object to monitor

ifInDiscards The number of inbound packets that are discarded even the packets are normal

ifInErrors The number of inbound packets that contained errors preventing them from being deliverable to a higher-layer protocol

ifInNUcastPkts The number of broad-cast and multi-cast packets delivered to a higher-layer protocol

ifInOctets The total number of octets received on the interface, including framing characters

ifInUcastPkts The number of uni-cast packets delivered to a higher-layer protocol

ifInUnknownProtos The number of the inbound packets that were discarded because of the unknown or un-support protocol

ifOutDiscards The number of outbound packets that are discarded event the packets is normal

ifOutErrors The The number of outbound packets that could not be transmitted because of errors

ifOutNUcastPkts The number of broad-cast and multi-cast packets that request to transmit

ifOutOctets The number of octets transmitted out of the interface, including framing characters

<uint> ifIndex

<interval: 1-2147483647> Sample interval

absolute Test each sample directly

delta Test delta between samples

rising-threshold Configure the rising threshold

<rising_threshold: -2147483648-2147483647> rising threshold value

<rising_event_id: 0-65535> Event to fire on rising threshold crossing

falling-threshold Configure the falling threshold

<falling_threshold: -2147483648-2147483647> falling threshold value

<falling_event_id: 0-65535> Event to fire on falling threshold crossing

both Trigger alarm when the first value is larger than the rising threshold or less than the falling threshold (default)

falling Trigger alarm when the first value is less than the falling threshold

rising Trigger alarm when the first value is larger than the rising threshold

Default:

None

Usage Guide:

To configure the **Alarm** of **RMON**

Example:

To configure the **Alarm** (below table) of **RMON**

ID	Interval	Variable	Sample Type	Value	Startup Alarm	Rising Threshold	Rising Index	Falling Threshold	Falling Index	
1	50	.1.3.6.1.2.1.2.2.1.	Absolute	10.15	0	Falling	1000	1	520	1

```
Switch# configure terminal
Switch (config)# rmon alarm 1 .1.3.6.1.2.1.2.2.1.10.15 50 absolute rising-threshold
1000 1 falling-threshold 520 1 falling
```

4.2.200 rmon event

Command:

```
rmon event <id: 1-65535> [ log ] [ trap <community> ] { [ description <description> ] }
```

- rmon** Remote Monitoring
- event** Configure an RMON event
- <id: 1-65535>** Event entry ID
- description** Specify a description of the event
- <description>** Event description
- log** Generate RMON log when the event fires
- trap** Generate SNMP trap when the event fires
- <community>** SNMP community string

Default:

None

Usage Guide:

To configure the **Event** of **RMON**

Example:

To configure the **Event** (below table) of **RMON**

ID	Desc	Type	Community	Event Last Time
1	error	logandtrap	planet	0

```
Switch# configure terminal
Switch (config)# rmon event 1 log trap planet description error
```

4.2.201 sflow agent-ip

Command:

```
sflow agent-ip { ipv4 <v_ipv4_addr> | ipv6 <v_ipv6_addr> }
```

sflow Statistics flow

agent-ip The agent IP address used as agent-address in UDP datagrams. Defaults to IPv4 loopback address.

Default:

None

Usage Guide:

To configure the **agent IP address** of **sFlow**

Example:

To configure the **agent IP address** (10.10.10.10) of **sFlow**

```
Switch# configure terminal
Switch (config)# sflow agent-ip ipv4 10.10.10.10
```

4.2.202 sflow collector-address

Command:

```
sflow collector-address <hostname>
```

sflow Statistics flow

collector-address Collector address

<hostname> IPv4 address or IPv6 address or hostname identifying the collector receiver

Default:

None

Usage Guide:

To configure the **Collector address** of **sFlow**

Example:

To configure the **Collector address** (10.10.10.10) of **sFlow**

```
Switch# configure terminal
Switch (config)# sflow collector-address 10.10.10.10
```

4.2.203 sflow collector-port

Command:

```
sflow collector-port <collector_port>
```

sflow Statistics flow

collector-port Collector UDP port

<Collector Port : 1-65535> Port number

Default:

None

Usage Guide:

To configure the **Collector port number** of **sFlow**

Example:

To configure the **Collector port number** (555) of **sFlow**

```
Switch# configure terminal
Switch (config)# sflow collector-port 555
```

4.2.204 sflow max-datagram-size

Command:

```
sflow max-datagram-size <datagram_size>
```

sflow Statistics flow

max-datagram-size Maximum datagram size

<DatagramSize : 200-1468> bytes

Default:

None

Usage Guide:

To configure the **Collector Maximum datagram size** of **sFlow**

Example:

To configure the **Collector Maximum datagram size** (555 bytes) of **sFlow**

```
Switch# configure terminal
Switch (config)# sflow max-datagram-size 555
```

4.2.205 sflow timeout

Command:

```
sflow timeout <timeout>
```

sflow Statistics flow

timeout Receiver timeout measured in seconds. The switch decrements the timeout once per second, and as long as it is non-zero, the receiver receives samples. Once the timeout reaches 0, the receiver and all its configuration is reset to defaults.

<timeout: 0-2147483647> Number of seconds

Default:

None

Usage Guide:

To configure the **Collector timeout** of **sFlow**

Example:

To configure the **Collector timeout** (555 seconds) of **sFlow**

```
Switch# configure terminal
Switch (config)# sflow timeout 555
```

4.2.206 sfp temperature-threshold

Command:

```
sfp temperature-threshold <0-100>
```

sfp temperature-threshold Set a lower high temperature threshold for the secondary temperature alarm in degrees C.

<0-100> Specifies the new threshold temperature.

Default:

None

Usage Guide:

To configure the **SFP temperature-threshold** of **sFlow**

Example:

To configure the **SFP temperature-threshold** (55 degrees C) of **sFlow**

```
Switch# configure terminal
```

```
Switch (config)# sfp temperature-threshold 55
```

4.2.207 snmp-server

Command:

```
snmp-server
```

snmp-server Set SNMP server's configurations

Default:

Enabled

Usage Guide:

To enable the SNMP Service

Example:

To enable the SNMP Service

```
Switch# configure terminal
Switch (config)# snmp-server
```

4.2.208 snmp-server access

Command:

```
snmp-server access <group_name> model { v1 | v2c | v3 | any } level { auth | noauth |
priv } [ read <view_name> ] [ write <write_name> ]
```

snmp-server Set SNMP server's configurations

access access configuration

<GroupName : word32> group name

model security model

any any security model

v1 v1 security model

v2c v2c security model

v3 v3 security model

level security level

auth authNoPriv Security Level

noauth noAuthNoPriv Security Level

priv authPriv Security Level

read specify a read view for the group

<ViewName : word255> read view name

write specify a write view for the group

<WriteName : word255> write view name

Default:

None

Usage Guide:

To configure the **Access** of **SNMP**

Example:

To configure the **Access** (below table) of **SNMP**

Group Name	Security Model	Security Level	Read View Name	Write View Name
default_rw_group	v2c	Auth, Priv	default_view ▼	default_view ▼

```
Switch# configure terminal
Switch (config)# snmp-server access default_rw_group model v2c level priv read
default_view write default_view
```

4.2.209 snmp-server community

Command:

```
snmp-server community { v2c <comm> [ ro | rw ] | v3 <v3_comm> [ <v_ipv4_addr>
<v_ipv4_netmask> ] }
```

snmp-server Set SNMP server's configurations

community Set the SNMP community

v2c SNMPv2c

<comm> Community word

ro Read only

rw Read write

v3 SNMPv3

<V3Comm : word127> Community word

<ipv4_addr> IPv4 address

<ipv4_netmask> IPv4 netmask

Default:

None

Usage Guide:

To configure the **Read / Write / Source network Community** of **SNMP**

Example:

To configure the **Read / Write / Source network Community** (below table) of **SNMP**

Community	Source IP	Source Mask
public	192.168.0.15	255.255.255.0

```
Switch# configure terminal
```

```
Switch (config)# snmp-server community v3 public 192.168.0.15 255.255.255.0
```

4.2.210 snmp-server contact

Command:

```
snmp-server contact <line255>
```

snmp-server Set SNMP server's configurations

contact Set the SNMP server's contact string

<line255> contact string

Default:

None

Usage Guide:

To configure the **sysContact string** of **SNMP**

Example:

To configure the **sysContact string (Server123)** of **SNMP**

```
Switch# configure terminal
```

```
Switch (config)# snmp-server contact Server123
```

4.2.211 snmp-server engine-id

Command:

```
snmp-server engine-id local <Engineid : word10-32>
```

snmp-server Set SNMP server's configurations

engine-id Set SNMP engine ID

local Set SNMP local engine ID

<Engineid : word10-32> local engine ID

Default:

None

Usage Guide:

To configure the **Engine ID** of **SNMP**

Example:

To configure the **Engine ID** (1234567890) of **SNMP**

```
Switch# configure terminal
Switch (config)# snmp-server engine-id local 1234567890
```

4.2.212 snmp-server host

Command:

```
snmp-server host <conf_name>
```

snmp-server Set SNMP server's configurations

host Set SNMP host's configurations

<conf_name> Name of the host configuration

Default:

None

Usage Guide:

To enter the **SNMP host mode**

Example:

To enter the **SNMP host mode (planet)**

```
Switch# configure terminal
Switch (config)# snmp-server host planet
Switch (config-snmps-host)#
```

4.2.212.1 do

Command:

```
do < exec commands >
```

do To run exec commands.

Default:

N/A

Usage Guide:

To run **exec commands**.

Example:

To run "show aaa".

```
Switch# configure terminal
Switch (config)# snmp-server host planet
Switch (config-snmps-host)#do show aaa
console : local
telnet  : local
ssh     : local
http   : local
```

4.2.212.2 end

Command:

```
end
```

end Go back to EXEC mode

Default:

Auto

Usage Guide:

To back to **EXEC mode**

Example:

To back to **EXEC mode**

```
Switch# configure terminal
Switch (config)# snmp-server host planet
Switch (config-snmps-host)#end
Switch#
```

4.2.212.3 exit

Command:

```
exit
```

exit Exit from current mode

Default:

None

Usage Guide:

To exit current mode

Example:

To exit current mode.

```
Switch# configure terminal
Switch (config)# snmp-server host planet
Switch (config-snmps-host)#exit
Switch (config)#
```

4.2.212.4 host

Command:

```
host [<hostname> | <ipv4_ucast> | <ipv6_ucast>] <UdpPort : 1-65535> { informs | traps }
```

- host** host configuration
- <hostname>** hostname of SNMP trap host
- <ipv4_ucast>** IP address of SNMP trap host
- <ipv6_ucast>** IP address of SNMP trap host
- <UdpPort : 1-65535>** UDP port of the trap messages
- informs** Send Inform messages to this host
- traps** Send Trap messages to this host

Default:

None

Usage Guide:

To configure **Trap Host** of **SNMP**

Example:

To configure **Trap Host** (below table) of **SNMP**

Trap Destination Address	planet.com
Trap Destination Port	66
Trap Inform Mode	Enabled <input type="button" value="v"/>

```
Switch# configure terminal
Switch (config)# snmp-server host planet
Switch (config-snmps-host)# host planet.com 66 informs
```

4.2.212.5 no

Command:

```
no
```

no Negate a command or set its defaults

Default:

N/A

Usage Guide:

To default the function

Example:

To disable the function (**host planet.com 66 informs**)

```
Switch# configure terminal
Switch (config)# snmp-server host planet
Switch (config-snmps-host)# no ip address dhcp
```

4.2.212.6 informs

Command:

```
informs retries <retries> timeout <timeout>
```

informs Send Inform messages to this host

retries retires inform messages

<Retries : 0-255> retires times

timeout timeout parmater

<Timeout : 0-2147> timeout interval

Default:

None

Usage Guide:

To configure **Trap Inform time** of **SNMP**

Example:

To configure **Trap Inform time** (below table) of **SNMP**

Trap Inform Timeout (seconds)	55
Trap Inform Retry Times	2

```
Switch# configure terminal
Switch (config)# snmp-server host planet
Switch (config-snmps-host)# informs retries 2 timeout 55
```

4.2.212.7 shutdown

Command:

```
shutdown
```

shutdown Disable the trap configuration

Default:

Disabled

Usage Guide:

To disable **Trap mode** of **SNMP**

Example:

To disable **Trap mode** of **SNMP**

```
Switch# configure terminal
Switch (config)# snmp-server host planet
Switch (config-snmps-host)# shutdown
```

4.2.212.8 traps

Command:

```
traps [ aaa authentication ] [ system [ coldstart ] [ warmstart ] ] [ switch [ stp ]
[ rmon ] ]
```

traps trap event configuration

aaa AAA event group

authentication Authentication fail event

switch Switch event group

system System event group

coldstart Cold start event

warmstart Warm start event

rmon RMON event

stp STP event

Default:

Disabled

Usage Guide:

To configure **Trap event** of **SNMP**

Example:

To configure **Trap event (STP, RMON)** of **SNMP**

```
Switch# configure terminal
Switch (config)# snmp-server host planet
Switch (config-snmps-host)# traps switch rmon stp
```

4.2.212.9 version

Command:

```
version { v1 [ <v1_comm> ] | v2 [ <v2_comm> ] | v3 [ probe | engineID
<v_word10_to_32> ] [ <securtyname> ] }
```

- version** Set SNMP trap version
- v1** SNMP trap version 1
- <V1Comm : word127>** SNMP trap community
- v2** SNMP trap version 2
- <V2comm : word127>** SNMP trap community
- v3** SNMP trap version 3
- <Securtyname : word32>** seucrity name
- engineID** Configure trap server's engine ID
- probe** Probe trap server's engine ID

Default:

Disabled

Usage Guide:

To configure **Version** of **SNMP**

Example:

To configure **Version (below table)** of **SNMP**

Trap Version	SNMP v2c
Trap Community	planet

```
Switch# configure terminal
Switch (config)# snmp-server host planet
```

```
Switch (config-snmps-host)# version v2 planet
```

4.2.213 spanning-tree aggregation

Command:

```
spanning-tree aggregation
```

spanning-tree Spanning Tree protocol

aggregation Aggregation mode

Default:

None

Usage Guide:

To enter **aggregation mode** of STP

Example:

To enter **aggregation mode** of STP

```
Switch# configure terminal
Switch (config)# spanning-tree aggregation
Switch (config-stp-aggr)#
```

4.2.213.1 do

Command:

```
do < exec commands >
```

do To run exec commands.

Default:

N/A

Usage Guide:

To run **exec commands**.

Example:

To run "show aaa".

```
Switch# configure terminal
Switch (config)# spanning-tree aggregation
Switch (config-stp-aggr)#do show aaa
console : local
telnet : local
```

```
ssh      : local
http     : local
```

4.2.213.2 end

Command:

```
end
```

end Go back to EXEC mode

Default:

Auto

Usage Guide:

To back to **EXEC mode**

Example:

To back to **EXEC mode**

```
Switch# configure terminal
Switch (config)# spanning-tree aggregation
Switch (config-stp-aggr)#end
Switch#
```

4.2.213.3 exit

Command:

```
exit
```

exit Exit from current mode

Default:

None

Usage Guide:

To exit current mode

Example:

To exit current mode.

```
Switch# configure terminal
Switch (config)# spanning-tree aggregation
Switch (config-stp-aggr)#exit
```

```
Switch (config)#
```

4.2.213.4 no

Command:

```
no
```

no Negate a command or set its defaults

Default:

N/A

Usage Guide:

To default the function

Example:

To disable the function (**spanning-tree auto-edge**)

```
Switch# configure terminal
Switch (config)# snmp-server host planet
Switch (config-snmps-host)# no spanning-tree auto-edge
```

4.2.213.5 spanning-tree auto-edge

Command:

```
spanning-tree auto-edge
```

spanning-tree Spanning Tree protocol

auto-edge Auto detect edge status

Default:

Enabled

Usage Guide:

To enable the **Auto Edge** of **CIST Aggregated Port**

Example:

To enable the **Auto Edge** of **CIST Aggregated Port**

```
Switch# configure terminal
Switch (config)# snmp-server host planet
```

```
Switch (config-snmps-host)# spanning-tree auto-edge
```

4.2.213.6 spanning-tree bpduguard

Command:

```
spanning-tree bpduguard
```

spanning-tree Spanning Tree protocol
bpduguard Enable/disable BPDU guard

Default:

Disabled

Usage Guide:

To enable the **BPDU Guard** of **CIST Aggregated Port**

Example:

To enable the **BPDU Guard** of **CIST Aggregated Port**

```
Switch# configure terminal
Switch (config)# snmp-server host planet
Switch (config-snmps-host)# spanning-tree bpduguard
```

4.2.213.7 spanning-tree edge

Command:

```
spanning-tree edge
```

spanning-tree Spanning Tree protocol
edge Edge port

Default:

Disabled

Usage Guide:

To enable the **Admin Edge** of **CIST Aggregated Port**

Example:

To enable the **Admin Edge** of **CIST Aggregated Port**

```
Switch# configure terminal
Switch (config)# snmp-server host planet
Switch (config-snmps-host)# spanning-tree edge
```

4.2.213.8 spanning-tree link-type

Command:

```
spanning-tree link-type link-type { point-to-point | shared | auto }
```

spanning-tree Spanning Tree protocol

link-type Port link-type

auto Auto detect

point-to-point Forced to point-to-point

shared Forced to Shared

Default:

Point to Point

Usage Guide:

To configure the **Point to Point mode (Shared)** of CIST Aggregated Port

Example:

To configure the **Point to Point mode (Shared)** of CIST Aggregated Port

```
Switch# configure terminal
Switch (config)# snmp-server host planet
Switch (config-snmps-host)# spanning-tree link-type shared
```

4.2.213.9 spanning-tree mst <instance> cost

Command:

```
spanning-tree mst <instance> cost { <cost> | auto }
```

spanning-tree Spanning Tree protocol

mst STP bridge instance

<Instance : 0-7> instance 0-7 (CIST=0, MST1=1...)

cost STP Cost of this port

<Cost : 1-200000000> Cost range

auto Use auto cost

Default:

Auto

Usage Guide:

To configure the **Path Cost** of **MSTI Port**

Example:

To configure the **Path Cost (321)** of **MSTI Port (MST 2)**

```
Switch# configure terminal
Switch (config)# snmp-server host planet
Switch (config-snmps-host)# spanning-tree mst 2 cost 321
```

4.2.213.10 spanning-tree mst <instance> port-priority

Command:

```
spanning-tree mst <instance> port-priority <prio>
```

spanning-tree Spanning Tree protocol
mst STP bridge instance
<Instance : 0-7> instance 0-7 (CIST=0, MST1=1...)
port-priority STP priority of this port
<Prio : 0-240> Range (lower higher priority)

Default:

Auto

Usage Guide:

To configure the **Port Priority** of **MSTI Port**

Example:

To configure the **Port Priority (96)** of **MSTI Port (MST 2)**

```
Switch# configure terminal
Switch (config)# snmp-server host planet
Switch (config-snmps-host)# spanning-tree mst 2 port-priority 96
```

4.2.213.11 spanning-tree restricted-role

Command:

```
spanning-tree restricted-role
```

spanning-tree Spanning Tree protocol
restricted-role Port role is restricted (never root port)

Default:

Disabled

Usage Guide:To enable the **Restricted Role** of CIST**Example:**To enable the **Restricted Role** of CIST

```
Switch# configure terminal
Switch (config)# snmp-server host planet
Switch (config-snmps-host)# spanning-tree restricted-role
```

4.2.213.12 spanning-tree restricted-tcn

Command:

```
spanning-tree restricted-tcn
```

spanning-tree Spanning Tree protocol
restricted-tcn Restrict topology change notifications

Default:

Disabled

Usage Guide:To enable the **Restricted TCN** of CIST**Example:**To enable the **Restricted TCN** of CIST

```
Switch# configure terminal
(config)# spanning-tree aggregation
(config-stp-aggr)# spanning-tree restricted-tcn
```

4.2.214 switchport vlan mapping

Command:

```
switchport vlan mapping <group> <vlan_list> <translation_vlan>
```

switchport Set switching mode characteristics
vlan vlan - Vlan translation
mapping Add VLAN translation entry into a group
<group id : 1-29> Group id

<vlan_list> VLAN list

< translation_vlan > translation VLAN ID

Default:

None

Usage Guide:

To configure the **VLAN Translation**

Example:

To enable the **VLAN Translation (below table)**

Group ID	VLAN ID	Translated to VID
1	3	5

```
Switch# configure terminal
Switch (config)# switchport vlan mapping 1 3 5
```

4.2.215 tacacs-server deadtime

Command:

```
tacacs-server deadtime <minutes>
```

tacacs-server Configure TACACS+

deadtime Time to stop using a TACACS+ server that doesn't respond

<Minutes : 1-1440> Time in minutes

Default:

0

Usage Guide:

To configure the **Deadtime of TACACS+ Server**

Example:

To enable the **Deadtime (6) of TACACS+ Server**

```
Switch# configure terminal
Switch (config)# tacacs-server deadtime 6
```

4.2.216 tacacs-server host

Command:

```
tacacs-server host <host_name> [ port <port> ] [ timeout <seconds> ] [ key <key> ]
```

tacacs-server Configure TACACS+

host Specify a TACACS+ server

<HostName : word1-255> Hostname or IP address

key Server specific key (overrides default)

port TCP port for TACACS+ server

<Port : 0-65535> TCP port number

timeout Time to wait for this TACACS+ server to reply (overrides default)

<Seconds : 1-1000> Wait time in seconds

<Key : line1-63> The shared key

Default:

None

Usage Guide:

To configure the **Host of TACACS+ Server**

Example:

To enable the **Host (below table) of TACACS+ Server**

```
Switch# configure terminal
```

```
Switch (config)# tacacs-server host planet.com port 55 timeout 6 key 7788
```

4.2.217 transport email authentication

Command:

```
transport email authentication username <username> password <password>
```

transport Enable or disable transport email function.

email Enable or disable transport email function.

authentication configure SMTP authentication's username and password

<Username> User name allows letters, numbers and underscores

<Password> The ENCRYPTED (hidden) user password. Notice the ENCRYPTED password will be decoded by system internally. You cannot directly use it as same as the Plain Text and it is not human-readable text normally.

Default:

N/A

Usage Guide:

To configure SMTP authentication's username and password

Example:

To configure SMTP authentication's username (123@planet.com.tw) and password (456)

```
Switch# configure terminal
Switch (config)# transport email authentication username 123@planet.com.tw
password 456
```

4.2.218 transport email from

Command:

```
transport email from <mail_addr> subject <title>
```

transport Enable or disable transport email function.

email Enable or disable transport email function.

from sender's email address

<mail_addr> mail address

subject subject/title of the email

<title> email title

Default:

N/A

Usage Guide:

To configure SMTP sender's email address and title of the email

Example:

To configure SMTP sender's email address (**sys@planet.com.tw**) and title of the email (**syserror**)

```
Switch# configure terminal
Switch (config)# transport email from sys@planet.com.tw subject syserror
```

4.2.219 transport email smtp-server

Command:

```
transport email smtp-server { <ipv4_addr> | <server> } port <1_to_65535>
```

transport Enable or disable transport email function.

email Enable or disable transport email function.

smtp-server Set the SMTP server name or IP address of the SMTP server

<ipv4_ucast> <ipv4_addr>: IP address

<server> hostname

port port

<1-65535> port_number: Specifies the port number. The range is from 1 to 65535. The default port number is 25.

Default:

N/A

Usage Guide:

To configure SMTP Server address and port number.

Example:

To configure SMTP Server address (**mail.planet.com.tw**) and port number (**123**)

```
Switch# configure terminal
Switch (config)# transport email smtp-server mail.planet.com.tw port 123
```

4.2.220 transport email to

Command:

```
transport email to <1 | 2> <mail_addr>
```

transport Enable or disable transport email function.

email Enable or disable transport email function.

to receiver's email

<1|2> 1: mail address 1 2: mail address 2

<mail_addr> mail address

Default:

N/A

Usage Guide:

To configure SMTP destination mail address.

Example:

To configure SMTP destination mail address 1 (**ss@planet.com.tw**).

```
Switch# configure terminal
Switch (config)# transport email to 1 ss@planet.com.tw
```

4.2.221 upnp

Command:

```
upnp
```

upnp Set UPnP's configurations

Default:

Disabled

Usage Guide:To enable the **UPnP service****Example:**To enable the **UPnP service**

```
Switch# configure terminal
Switch (config)# upnp
```

4.2.222 upnp advertising-duration

Command:

```
upnp advertising-duration <100-86400>
```

upnp Set UPnP's configurations
advertising-duration Set advertising duration
<100-86400> advertising duration

Default:

100

Usage Guide:To configure the **Advertising Duration of UPnP****Example:**To configure the **Advertising Duration (123) of UPnP**

```
Switch# configure terminal
Switch (config)# upnp advertising-duration 123
```

4.2.223 upnp ttl

Command:

```
upnp ttl <1-255>
```

upnp Set UPnP's configurations
ttl Set TTL value
<1-255> TTL value

Default:

4

Usage Guide:

To configure the **TTL** of **UPnP**

Example:

To configure the **TTL (8)** of **UPnP**

```
Switch# configure terminal
Switch (config)# upnp ttl 8
```

4.2.224 username

Command:

```
username <username> privilege <priv> password { encrypted <encry_password> |
none | unencrypted <password> }
```

username Establish User Name Authentication

<Username : word31> User name allows letters, numbers and underscores

privilege Set user privilege level

<privilegeLevel : 0-15> User privilege level

password Specify the password for the user

encrypted Specifies an ENCRYPTED password will follow

none NULL password

unencrypted Specifies an UNENCRYPTED password will follow

<Password : word4-44> The ENCRYPTED (hidden) user password. Notice the ENCRYPTED password will be decoded by system internally. You cannot directly use it as same as the Plain Text and it is not human-readable text

Default:

None

Usage Guide:

To configure the **Profiles** of **Username**

Example:

To configure the **Profiles** of **Username (Username: 1234, Password: 1234, Privilege Level: 15)**

```
Switch# configure terminal
Switch (config)# username 1234 privilege 15 password unencrypted 1234
Press ENTER to get started

Username: 1234
```

```
Password: 1234
```

```
#
```

4.2.225 vlan

Command:

```
vlan <vlist>
```

vlan VLAN commands

<vlan_list> VLAN IDs 1~4095

Default:

None

Usage Guide:

To create the **VLAN Profiles**

Example:

To create the **VLAN Profiles (VLAN 5)**

```
Switch# configure terminal
```

```
Switch (config)# vlan 5
```

```
Switch (config-vlan)#
```

4.2.225.1 do

Command:

```
do < exec commands >
```

do To run exec commands.

Default:

N/A

Usage Guide:

To run **exec commands**.

Example:

To run "show aaa".

```
Switch# configure terminal
```



```
Switch (config)# vlan 5
Switch (config-vlan)#do show aaa
console : local
telnet  : local
ssh    : local
http   : local
```

4.2.225.2 end

Command:

```
end
```

end Go back to EXEC mode

Default:

Auto

Usage Guide:

To back to **EXEC mode**

Example:

To back to **EXEC mode**

```
Switch# configure terminal
Switch (config)# vlan 5
Switch (config-vlan)#end
Switch#
```

4.2.225.3 exit

Command:

```
exit
```

exit Exit from current mode

Default:

None

Usage Guide:

To exit current mode

Example:

To exit current mode

```
Switch# configure terminal
Switch (config)# vlan 5
Switch (config-vlan)# exit
Switch (config)#
```

4.2.225.4 name

Command:

```
name <vlan_name>
```

name ASCII name of the VLAN

<vword32> The ASCII name for the VLAN

Default:

None

Usage Guide:

To configure description of **VLAN**

Example:

To configure description (FAE) of **VLAN**

```
Switch# configure terminal
Switch (config)# vlan 5
Switch (config-vlan)# name FAE
```

4.2.225.5 no

Command:

```
no
```

no Negate a command or set its defaults

Default:

N/A

Usage Guide:

To default the function

Example:

To disable the function (**name FAE**)

```
Switch# configure terminal
Switch (config)# vlan 5
Switch (config-vlan)# no name FAE
```

4.2.226 vlan ethertype s-custom-port

Command:

```
vlan ethertype s-custom-port <etype>
```

vlan VLAN commands

ethertype Ether type for Custom S-ports

s-custom-port Custom S-ports configuration

<etype> Ethertype (Range: 0x0600-0xffff)

Default:

0x88A8

Usage Guide:

To create the **Ethernet type of Custom S-ports**

Example:

To create the **Ethernet type (0x88A9) of Custom S-ports**

```
Switch# configure terminal
Switch (config)# vlan ethertype s-custom-port 0x88a9
```

4.2.227 vlan protocol

Command:

```
vlan protocol { { eth2 { <etype> | arp | ip | ipx | at } } | { snap { <oui> | rfc-1042 |
snap-8021h } <pid> } | { llc <dsap> <ssap> } } group <grp_id>
```

vlan VLAN commands

protocol Protocol-based VLAN commands

eth2 Ethernet-based VLAN commands

<0x600-0xffff> Ether Type(Range: 0x600 - 0xFFFF)

arp Ether Type is ARP

at Ether Type is AppleTalk

ip Ether Type is IP

ipx Ether Type is IPX

- llc** LLC-based VLAN group
- <0x0-0xff>** DSAP (Range: 0x00 - 0xFF)
- <0x0-0xff>** SSAP (Range: 0x00 - 0xFF)
- snap** SNAP-based VLAN group
- <0x0-0xfffff>** SNAP OUI (Range 0x000000 - 0FFFFFFF)
- rfc-1042** SNAP OUI is rfc-1042
- snap-8021h** SNAP OUI is 8021h
- group** Protocol-based VLAN group commands
- <grp_id>** Group Name (Range: 1 - 16 characters)

Default:

None

Usage Guide:

To configure the **Protocol-based VLAN**

Example:

To configure the **Protocol-based VLAN (below table)**

Frame Type	Value	Group Name
LLC	55-66	3

```
Switch# configure terminal
Switch (config)# vlan protocol llc 0x55 0x66 group 3
```

4.2.228 voice vlan

Command:

```
voice vlan
```

- voice** Voice appliance attributes
- vlan** Vlan for voice traffic

Default:

Disabled

Usage Guide:

To enable the **Voice VLAN** service

Example:

To enable the **Voice VLAN** service

```
Switch# configure terminal
Switch (config)# voice vlan
```

4.2.229 voice vlan aging-time

Command:

```
voice vlan aging-time <aging_time>
```

voice Voice appliance attributes

vlan Vlan for voice traffic

aging-time Set secure learning aging time

<AgingTime : 10-10000000> Aging time, 10-10000000 seconds

Default:

86400

Usage Guide:

To configure the **Aging Time** of **Voice VLAN**

Example:

To configure the **Aging Time** of **Voice VLAN**

```
Switch# configure terminal
Switch (config)# voice vlan aging-time 8888
```

4.2.230 voice vlan class

Command:

```
voice vlan class <traffic_class>
```

voice Voice appliance attributes

vlan Vlan for voice traffic

class Set traffic class

< traffic_class : 0-7> Traffic class value

Default:

7

Usage Guide:

To configure the **Traffic Class** of **Voice VLAN**

Example:

To configure the **Traffic Class (5)** of **Voice VLAN**

```
Switch# configure terminal
Switch (config)# voice vlan class 5
```

4.2.231 voice vlan oui

Command:

```
voice vlan oui <oui> [ description <description> ]
```

voice Voice appliance attributes

vlan Vlan for voice traffic

oui OUI configuration

<oui> OUI value

description Set description for the OUI

<Description : line32> Description line

Default:

None

Usage Guide:

To configure the **OUI** of **Voice VLAN**

Example:

To configure the **OUI (OUI: 00:45:89, Description: qwe)** of **Voice VLAN**

```
Switch# configure terminal
Switch (config)# voice vlan oui 00:45:89 description qwe
```

4.2.232 voice vlan vid

Command:

```
voice vlan vid <vlan_id>
```

voice Voice appliance attributes

vlan Vlan for voice traffic

vid Set VLAN ID

<vlan_id> VLAN ID, 1-4095

Default:

1000

Usage Guide:

To configure the **VID** of **Voice VLAN**

Example:

To configure the **VID (66)** of **Voice VLAN**

```
Switch# configure terminal
Switch (config)# voice vlan vid 66
```

4.2.233 web privilege group

Command:

```
web privilege group <group_name> level { [ cro <cro: 0-15> ] [ crw <crw: 0-15> ] [ sro <sro: 0-15> ] [ srw <srw: 0-15> ] }
```

- web** Web
- privilege** Web privilege
- group** Web privilege group
- <vlan_id>** VLAN ID, 1-4095
- <group_name>** Valid words are 'Aggregation' 'DHCP' 'Debug' 'Dhcp_Client' 'Diagnostics' 'EPS' 'ERPS' 'ETH_LINK_OAM' 'EVC' 'Green_Ethernet' 'IP2' 'IPMC_Snooping' 'LACP' 'LLDP' 'Loop_Protect' 'MAC_Table' 'MEP' 'MVR' 'Maintenance' 'Mirroring' 'NTP' 'POE' 'PTP' 'Ports' 'Private_VLANS' 'QoS' 'RPC' 'Security' 'Spanning_Tree' 'System' 'Timer' 'UPnP' 'VCL' 'VLAN_Translation' 'VLANS' 'Voice_VLAN' 'XXRP' 'ZL_3034X_API'
- level** Web privilege group level
- cro** Configuration Read-only level
- crw** Configuration Read-write level
- sro** Status/Statistics Read-only level
- srw** Status/Statistics Read-write level

Default:

N/A

Usage Guide:

To configure the **Privilege Level**

Example:

To configure the **Privilege Level (below table)**

Group Name	Privilege Levels			
	Configuration Read-only	Configuration/Execute Read/write	Status/Statistics Read-only	Status/Statistics Read/write
Aggregation	3	4	3	5

```
Switch# configure terminal
```

```
Switch (config)# web privilege group Aggregation level cro 3 crw 4 sro 3 srw 5
```

4.3 copy

4.3.1 copy

Command:

```
copy { startup-config | running-config | <source_path> } { startup-config |
running-config | <destination_path> } [ syntax-check ]
```

copy Copy from source to destination

flash:filename | tftp://server/path-and-filename File in FLASH or on TFTP server

running-config Currently running configuration

startup-config Startup configuration Output modifiers

syntax-check Perform syntax check on source configuration

Default:

None

Usage Guide:

To copy configuration from source to destination

Example:

To copy configuration from source (**running-config**) to destination (**startup-config**)

```
Switch# copy running-config startup-config
```

4.4 debug

4.4.1 debug

Command:

```
debug prompt <debug_prompt>
```

debug Debugging functions

prompt Set prompt for testing

<debug_prompt> Word for prompt

Default:

None

Usage Guide:

To configure Description of **Debug Prompt**

Example:

To configure Description (1233) of **Debug Prompt**

```
Switch # debug prompt 1233
1233#
```

4.5 delete

4.5.1 delete

Command:

```
delete <path>
```

delete Delete one file in flash: file system

<Path : word> Name of file to delete

Default:

None

Usage Guide:

To delete Configuration File of **Flash**

Example:

To delete Configuration File (222) of **Flash**

```
Switch # copy running-config flash:222
Building configuration...
% Saving 1833 bytes to flash:222

Switch # dir
Directory of flash:
   r- 1970-01-01 00:00:00      648 default-config
   rw 1970-01-01 07:26:26     1833 startup-config
   rw 1970-01-01 00:18:40     1833 222

3 files, 4314 bytes total.

Switch # delete flash:222
```

```
Switch # dir
Directory of flash:
  r- 1970-01-01 00:00:00      648 default-config
  rw 1970-01-01 07:26:26    1833 startup-config
2 files, 2481 bytes total.
```

4.6 dir

4.6.1 dir

Command:

```
dir
```

dir Directory of all files in flash: file system

Default:

None

Usage Guide:

To list directory of file system

Example:

To list directory of file system

```
Switch # dir
Directory of flash:
  r- 1970-01-01 00:00:00      648 default-config
  rw 1970-01-01 07:26:26    1833 startup-config
2 files, 2481 bytes total.
```

4.7 disable

4.7.1 disable

Command:

```
disable
```

disable Turn off privileged commands

Default:

None

Usage Guide:

To exit **enable mode**

Example:

To exit **enable mode**

```
Switch # disable
Switch >
```

4.8 do

4.8.1 do

Command:

```
do < exec commands >
```

do To run exec commands.

Default:

N/A

Usage Guide:

To run **exec commands**.

Example:

To run "show aaa".

```
Switch# do show aaa
console : local
telnet  : local
ssh     : local
http   : local
```

4.9 dot1x

4.9.1 dot1x initialize

Command:

```
dot1x initialize [ interface ( <port_type> [ <plist> ] ) ]
```

dot1x IEEE Standard for port-based Network Access Control

initialize Force re-authentication immediately

Default:

N/A

Usage Guide:

To re-authenticate specific interface immediately.

Example:

To re-authenticate specific interface (**GigabitEthernet 1/1**) immediately.

```
Switch# dot1x initialize interface GigabitEthernet 1/1
```

4.10 enable

4.10.1 enable

Command:

```
enable
```

enable Turn on privileged commands

Default:

None

Usage Guide:

To enter **enable mode**

Example:

To enter **enable mode**

Switch > **enable**

Switch #

4.11 erps

4.11.1 erps

Command:

```
erps <group> command { force | manual | clear } { port0 | port1 }
```

erps Ethernet Ring Protection Switching

1-64 ERPS group number

command Administrative Command

clear Clear command

force Force command

manual Manual command

port0 ERPS Port 0 interface

port1 ERPS Port 1 interface

Default:

None

Usage Guide:

To configure **Instance Command** of **Group**

Example:

To configure **Instance Command** (below table) of **Group (1)**

Command	Port
Forced Switch ▾	Port0 ▾

```
Switch # erps 1 command force port0
```

4.12 exit

4.12.1 exit

Command:

```
exit
```

exit Exit from EXEC mode

Default:

None

Usage Guide:

To exit EXEC mode

Example:

To exit EXEC mode

```
Switch # disable
```

```
Switch > exit
```

```
Press ENTER to get started
```

4.13 firmware

4.13.1 firmware swap

Command:

```
firmware swap
```

firmware Firmware upgrade/swap

swap Swap between Active and Alternate firmware image

Default:

None

Usage Guide:

To swap **Active** and **Alternate firmware image**

Example:

To swap **Active** and **Alternate** firmware image

```
Switch # firmware swap
```

4.13.2 firmware upgrade

Command:

```
firmware upgrade <tftpserver_path_file>
```

firmware Firmware upgrade/swap

upgrade Firmware upgrade

<TFTPServer_path_file : word> TFTP Server IP address, path and file name for the server containing the new image.

Default:

None

Usage Guide:

To upgrade firmware via **TFTP Server**

Example:

To upgrade firmware via **TFTP Server (File: tftp://192.168.0.11/switch.bin)**

```
Switch # firmware upgrade tftp://192.168.0.11/switch.bin
```

4.14 ip

4.14.1 ip dhcp retry interface vlan

Command:

```
ip dhcp retry interface vlan <vlan_id>
```

ip IPv4 commands

dhcp Dhcp commands

retry Restart the DHCP query process

interface Interface

vlan Vlan interface

<vlan_id> Vlan ID

Default:

None

Usage Guide:

To do **DHCP renew** for specific VLAN

Example:

To do **DHCP renew** for specific VLAN (6)

```
Switch # ip dhcp retry interface vlan 6
```

4.15 logout

4.15.1 logout

Command:

```
logout
```

logout Exit from EXEC mode

Default:

None

Usage Guide:

To exit EXEC mode

Example:

To exit EXEC mode

```
Switch # logout
```

```
Press ENTER to get started
```

4.16 more

4.16.1 more

Command:

```
more <path>
```

more Display file

<Path> File in FLASH or on TFTP server

Default:

None

Usage Guide:

To view the file

Example:

To view the file (222)

```
Switch # copy running-config flash:222
Building configuration...
% Saving 2038 bytes to flash:222

Switch # more flash:222
hostname Switch
username admin privilege 15 password none
!
vlan 1
!
vlan 5
!
!
!
```

4.17 no

4.17.1 no

Command:

```
no
```

no Negate a command or set its defaults

Default:

N/A

Usage Guide:

To default the function

Example:

To disable the function (**erps 1 command force port0**)

```
Switch# no erps 1 command force port0
```

4.18 ping

4.18.1 ping ip

Command:

```
ping ip <v_ip_addr> [ repeat <count> ] [ size <size> ] [ interval <seconds> ]
```

ping Send ICMP echo messages

ip IP (ICMP) echo

<v_ip_addr> ICMP destination address

interval Specify repeat interval

<Seconds : 0-30> 0-30; Default is 0

repeat Specify repeat count

<Count : 1-60> 1-60; Default is 5

size Specify datagram size

<Size : 2-1452> 2-1452; Default is 56 (excluding MAC, IP and ICMP headers)

Default:

N/A

Usage Guide:

To run the **IPv4 Ping** function

Example:

To run the **IPv4 Ping** (192.168.0.78) function

```
Switch# ping ip 192.168.0.78
PING server 192.168.0.78, 56 bytes of data.
64 bytes from 192.168.0.78: icmp_seq=0, time=0ms
64 bytes from 192.168.0.78: icmp_seq=1, time=0ms
64 bytes from 192.168.0.78: icmp_seq=2, time=0ms
64 bytes from 192.168.0.78: icmp_seq=3, time=0ms
64 bytes from 192.168.0.78: icmp_seq=4, time=0ms
Sent 5 packets, received 5 OK, 0 bad
```

4.18.2 ping ipv6

Command:

```
ping ipv6 <v_ipv6_addr> [ repeat <count> ] [ size <size> ] [ interval <seconds> ]
[ interface vlan <v_vlan_id> ]
```

ping Send ICMP echo messages

ipv6 IPv6 (ICMPv6) echo

interface Select an interface to configure

vlan VLAN Interface

<v_vlan_id> VLAN identifier(s): VID

interval Specify repeat interval

<Seconds : 0-30> 0-30; Default is 0

repeat Specify repeat count

<Count : 1-60> 1-60; Default is 5

size Specify datagram size

<Size : 2-1452> 2-1452; Default is 56 (excluding MAC, IP and ICMP headers)

Default:

N/A

Usage Guide:

To run the **IPv6 Ping** function

Example:

To run the **IPv6 Ping** (2001::7788) function

```
Switch# ping ipv6 2001::7788
PING6 server 2001::7788, 56 bytes of data.
rcvfrom: Operation timed out
rcvfrom: Operation timed out
rcvfrom: Operation timed out
rcvfrom: Operation timed out
rcvfrom: Operation timed out
rcvfrom: Operation timed out
Sent 5 packets, received 0 OK, 0 bad
```

4.19 reload

4.19.1 reload cold

Command:

```
reload cold
```

reload Reload system

cold Reload cold.

Default:

N/A

Usage Guide:

To restart the device.

Example:

To restart the device.

```
Switch# reload cold
```

4.19.2 reload defaults

Command:

```
reload defaults [ keep-ip ]
```

reload Reload system

defaults Reload defaults without rebooting.

keep-ip Attempt to keep VLAN1 IP setup.

Default:

N/A

Usage Guide:

To store the device factory default settings.

Example:

To store the device factory default settings.

```
Switch# reload defaults
```

4.20 send

4.20.1 send

Command:

```
send { * | console 0 | vty <vty_list> } <message>
```

reload	Reload system
*	All tty lines
console	Primary terminal line
vty	Virtual terminal

Default:

N/A

Usage Guide:

To send message for **command line** user.

Example:

To send message (hi, I will upgrade the firmware, OK?) for **command line** user (All).

```
Switch # send * 1
Enter TEXT message. End with the character '^'.
hi, I will upgrade the firmware, OK?
1

-----
*** Message from line 0:

hi, I will upgrade the firmware, OK?

-----
```

4.21 show

4.21.1 show aaa

Command:

```
show aaa
```

show Show running system information

aaa Login methods

Default:

N/A

Usage Guide:

To display the **AAA** services.

Example:

To display the **AAA** services

```
Switch # show aaa
console : local
telnet  : local
ssh    : local
http   : local
```

4.21.2 show access management

Command:

```
show access management [ statistics | <access_id_list> ]
```

show Show running system information

access Access management

management Access management configuration

<AccessIdList : 1~16> ID of access management entry

Statistics Statistics data

Default:

N/A

Usage Guide:

To display **Access Management Statistics**.

Example:

To display **Access Management Statistics**.

```
Switch # show access management statistics

Access Management Statistics:
-----
HTTP   Receive:      0   Allow:      0   Discard:    0
HTTPS  Receive:      0   Allow:      0   Discard:    0
SNMP   Receive:      0   Allow:      0   Discard:    0
TELNET Receive:      0   Allow:      0   Discard:    0
SSH    Receive:      0   Allow:      0   Discard:    0
```

4.21.3 show access-list

Command:

```
show access-list [ interface [ ( <port_type> [ <v_port_type_list> ] ) ] ] [ rate-limiter
[ <rate_limiter_list> ] ] [ ace statistics [ <ace_list> ] ]
```

- show** Show running system information
- access** Access management
- management** Access management configuration
- <AccessIdList : 1~16>** ID of access management entry
- statistics** Statistics data

Default:

N/A

Usage Guide:

To display **ACL Statistics, Rate Limiter List, ACE Statistics**.

Example:

To display **ACL Statistics, Rate Limiter List, ACE Statistics** for interface **GigabitEthernet 1/1**.

```
Switch # show access-list interface GigabitEthernet 1/1 ace statistics rate-limiter

Switch access-list ace number: 0

Switch access-list rate limiter ID 1 is 1 pps
Switch access-list rate limiter ID 2 is 1 pps
Switch access-list rate limiter ID 3 is 1 pps
```

```
Switch access-list rate limiter ID 4 is 1 pps
Switch access-list rate limiter ID 5 is 1 pps
Switch access-list rate limiter ID 6 is 1 pps
Switch access-list rate limiter ID 7 is 1 pps
Switch access-list rate limiter ID 8 is 1 pps
Switch access-list rate limiter ID 9 is 1 pps
Switch access-list rate limiter ID 10 is 1 pps
Switch access-list rate limiter ID 11 is 1 pps
Switch access-list rate limiter ID 12 is 1 pps
Switch access-list rate limiter ID 13 is 1 pps
Switch access-list rate limiter ID 14 is 1 pps
Switch access-list rate limiter ID 15 is 1 pps
Switch access-list rate limiter ID 16 is 1 pps
```

```
GigabitEthernet 1/1 :
-----
GigabitEthernet 1/1 access-list action is permit
GigabitEthernet 1/1 access-list policy ID is 0
GigabitEthernet 1/1 access-list rate limiter ID is disabled
GigabitEthernet 1/1 access-list redirect is disabled
GigabitEthernet 1/1 access-list logging is disabled
GigabitEthernet 1/1 access-list shutdown is disabled
GigabitEthernet 1/1 access-list port-state is enabled
GigabitEthernet 1/1 access-list counter is 0
```

4.21.4 show access-list

Command:

```
show access-list [ interface [ ( <port_type> [ <v_port_type_list> ] ) ] ] [ rate-limiter
[ <rate_limiter_list> ] ] [ ace statistics [ <ace_list> ] ]
```

show Show running system information
access-list Access list
ace Access list entry
statistics Traffic statistics
interface Select an interface to configure
rate-limiter Rate limiter

Default:

N/A

Usage Guide:

To display the **ACL Statistics, Rate Limiter List, ACE Statistics**.

Example:

To display the **ACL Statistics, Rate Limiter List, ACE Statistics** for interface **GigabitEthernet 1/1**.

```
Switch # show access-list interface GigabitEthernet 1/1 ace statistics rate-limiter

Switch access-list ace number: 0

Switch access-list rate limiter ID 1 is 1 pps
Switch access-list rate limiter ID 2 is 1 pps
Switch access-list rate limiter ID 3 is 1 pps
Switch access-list rate limiter ID 4 is 1 pps
Switch access-list rate limiter ID 5 is 1 pps
Switch access-list rate limiter ID 6 is 1 pps
Switch access-list rate limiter ID 7 is 1 pps
Switch access-list rate limiter ID 8 is 1 pps
Switch access-list rate limiter ID 9 is 1 pps
Switch access-list rate limiter ID 10 is 1 pps
Switch access-list rate limiter ID 11 is 1 pps
Switch access-list rate limiter ID 12 is 1 pps
Switch access-list rate limiter ID 13 is 1 pps
Switch access-list rate limiter ID 14 is 1 pps
Switch access-list rate limiter ID 15 is 1 pps
Switch access-list rate limiter ID 16 is 1 pps

GigabitEthernet 1/1 :
-----
GigabitEthernet 1/1 access-list action is permit
GigabitEthernet 1/1 access-list policy ID is 0
GigabitEthernet 1/1 access-list rate limiter ID is disabled
GigabitEthernet 1/1 access-list redirect is disabled
GigabitEthernet 1/1 access-list logging is disabled
GigabitEthernet 1/1 access-list shutdown is disabled
GigabitEthernet 1/1 access-list port-state is enabled
GigabitEthernet 1/1 access-list counter is 0
```

4.21.5 show access-list ace-status

Command:

```
show access-list ace-status [ static ] [ link-oam ] [ loop-protect ] [ dhcp ] [ ptp ]
[ upnp ] [ arp-inspection ] [ mep ] [ ipmc ] [ ip-source-guard ] [ ip-mgmt ] [ conflicts ]
[ switch <switch_list> ]
```

show	Show running system information
access-list	Access list
arp-inspection	The ACEs that are configured by ARP Inspection module
conflicts	The ACEs that did not get applied to the hardware due to hardware limitations
dhcp	The ACEs that are configured by DHCP module
ip-source-guard	The ACEs that are configured by IP Source Guard module
ipmc	The ACEs that are configured by IPMC module
link-oam	The ACEs that are configured by Link OAM module
loop-protect	The ACEs that are configured by Loop Protect module
mep	The ACEs that are configured by MEP module
ptp	The ACEs that are configured by PTP module
static	The ACEs that are configured by users manually
upnp	The ACEs that are configured by UPnP module

Default:

N/A

Usage Guide:

To display the **ACE Status**.

Example:

To display the **ACE Status**.

```
Switch # show access-list ace-status
User
----
S   : Static
IPSG: IP Source Guard
IPMC: IPMC
MEP : MEP
ARPI: ARP Inspection
UPnP: UPnP
PTP : PTP
DHCP: DHCP
LOOP: Loop Protect
```

```

LOAM: Link OAM

User ID   Frame   Action Rate L.   CPU   Counter Conflict
-----
DHCP 1    UDP    Deny   Disabled Yes    0 No
DHCP 2    UDP    Deny   Disabled Yes    0 No
PTP 1     EType  Deny   Disabled Yes    0 No
PTP 2     EType  Deny   Disabled Yes    0 No

Switch 1 access-list ace number: 4
    
```

4.21.6 show aggregation

Command:

```
show aggregation [ mode ]
```

- show** Show running system information
- aggregation** Aggregation port configuration
- mode** Traffic distribution mode

Default:

N/A

Usage Guide:

To display the **Aggregation status**.

Example:

To display the **Aggregation status**.

```

Switch # show aggregation
AggrID   Name   Type   Speed   Configured Ports   Aggregated Ports
-----
    
```

4.21.7 show aggregation mode

Command:

```
show aggregation [ mode ]
```

- show** Show running system information
- aggregation** Aggregation port configuration
- mode** Traffic distribution mode

Default:

N/A

Usage Guide:

To display the **Aggregation mode status**.

Example:

To display the **Aggregation mode status**.

```
Switch # show aggregation mode
Aggregation Mode:

SMAC   : Enabled
DMAC   : Disabled
IP     : Enabled
Port   : Enabled
```

4.21.8 show clock

Command:

```
show clock
```

- show** Show running system information
- clock** Configure time-of-day clock

Default:

N/A

Usage Guide:

To display the **system time**.

Example:

To display the **system time**.

```
Switch # show clock
System Time      : 2014-01-01T00:25:51+00:00
```

4.21.9 show clock detail

Command:

```
show clock detail
```

show Show running system information
clock Configure time-of-day clock
detail Display detailed information

Default:

N/A

Usage Guide:

To display the detailed **system time**.

Example:

To display the detailed **system time**.

```
Switch # show clock detail
System Time      : 1970-01-01T00:29:25+00:00

Timezone : Timezone Offset : 0 ( 0 minutes)
Timezone Acronym :

Daylight Saving Time Mode : Disabled.
Daylight Saving Time Start Time Settings :
    Week: 0
    Day: 0
    Month: 0
    Date: 0
    Year: 0
    Hour: 0
    Minute: 0
Daylight Saving Time End Time Settings :
    Week: 0
    Day: 0
    Month: 0
    Date: 0
    Year: 0
    Hour: 0
    Minute: 0
Daylight Saving Time Offset : 1 (minutes)
```

4.21.10 show dot1x statistics

Command:

```
show dot1x statistics
```

show Show running system information

dot1x IEEE Standard for port-based Network Access Control

statistics Shows statistics for either eapol or radius

all Show all dot1x statistics

eapol Show EAPOL statistics

radius Show Backend Server statistics

interface Interface

Default:

N/A

Usage Guide:

To display the **IEEE 802.1X statistics**.

Example:

To display the **All of IEEE 802.1X statistics** for **interface GigabitEthernet 1/1**.

```
Switch # show dot1x statistics all interface GigabitEthernet 1/1
```

```
GigabitEthernet 1/1 EAPOL Statistics:
```

Rx Total:	0
Tx Total:	0
Rx Response/Id:	0
Tx Request/Id:	0
Rx Response:	0
Tx Request:	0
Rx Start:	0
Rx Logoff:	0
Rx Invalid Type:	0
Rx Invalid Length:	0

```
GigabitEthernet 1/1 Backend Server Statistics:
```

Rx Access Challenges:	0
Tx Responses:	0
Rx Other Requests:	0
Rx Auth. Successes:	0

Rx Auth. Failures:	0
--------------------	---

4.21.11 show dot1x status

Command:

show dot1x status [interface (<port_type> [<v_port_type_list>])] [brief]

- show** Show running system information
- dot1x** IEEE Standard for port-based Network Access Control
- status** Shows dot1x status, such as admin state, port state and last source.
- interface** Interface
- brief** Show status in a brief format

Default:

N/A

Usage Guide:

To display the **IEEE 802.1X status**.

Example:

To display the **All of IEEE 802.1X status** for brief.

```

Switch # show dot1x status
GigabitEthernet 1/1 :
-----
Admin State      Port State      Last Source      Last ID
-----
Force Authorized  Globally Disabled  -                -

Current Radius QOS  Current Radius VLAN  Current Guest VLAN
-----
-                  -                  -

GigabitEthernet 1/2 :
-----
Admin State      Port State      Last Source      Last ID
-----
Force Authorized  Globally Disabled  -                -

Current Radius QOS  Current Radius VLAN  Current Guest VLAN
-----
-                  -                  -
    
```

4.21.12 show eps

Command:

```
show eps [ <inst> ] [ detail ]
```

- show** Show running system information
- eps** Ethernet Protection Switching
- <Inst : range_list>** The range of EPS instances
- detail** Show detailed state including configuration information

Default:

N/A

Usage Guide:

To display the **EPS instance information**.

Example:

To display the **EPS instance 1 detailed information**.

```
Switch # show eps 1 detail

EPS state is:
  Inst      State      Wstate      Pstate      TxAps r b
  1         Disable      Ok          Ok          NR 0 0

  RxAps r b  FopPm      FopCm      FopNr      FopNoAps
  NR 0 0     False      False      False      False

EPS Configuration is:
  Inst      Dom      Archi      Wflow      Pflow      Wmep      Pmep
  1         Port    1plus1     1          2          3          4

  APSmep     Direct    Revert     Wtr        Hold       Aps
  5         xxx      xxx        xxx        xxx        xxx
```

4.21.13 show erps

Command:

```
show erps [ <groups> ] [ detail | statistics ]
```

show Show running system information

erps Ethernet Ring Protection Switching

<groups> Zero or more ERPS group numbers

detail Show detailed information

statistics Show statistics

Default:

N/A

Usage Guide:

To display the **ERPS group** information.

Example:

To display the **ERPS group 1** detailed information.

```
Switch # show erps 1 detail
Grp#  Port 0      Port 1      RPL:Role  Port  Blocking
  1  Gi 1/1      Gi 1/2      -          -        -
Protected VLANS:
  None
Protection Group State      :Active
Port 0 SF MEP               :1
Port 1 SF MEP               :2
Port 0 APS MEP              :1
Port 1 APS MEP              :2
WTR Timeout                 :1
WTB Timeout                  :5500
Hold-Off Timeout            :0
Guard Timeout               :500
Node Type                   :Major
Reversion                   :Revertive
Version                     :2
ERPSv2 Administrative Command :None

FSM State                   :PENDING
Port 0 Link Status          :Link Up
Port 1 Link Status          :Link Up
```

```

Port 0 Block Status      :BLOCKED
Port 1 Block Status      :BLOCKED
R-APS Transmission      :STOPPED
R-APS Port 0 Reception   :NONE
R-APS Port 1 Reception   :NONE
FOP Alarm                :OFF
    
```

4.21.14 show evc

Command:

```
show evc { [ <evc_id> | all ] } [ ece [ <ece_id> ] ]
```

show Show running system information

evc Ethernet Virtual Connections

<EvcId : 1-4096> EVC identifier

all Process all EVCs

ece EVC Control Entry

<EceId : 1-4096> ECE identifier

Default:

N/A

Usage Guide:

To display the **EVC status**.

Example:

To display the All of **EVC status**.

```

Switch # show evc all
EVC ID  Status
-----  -----
1       Active
    
```

4.21.15 show evc statistics

Command:

```
show green-ethernet [ interface ( <port_type> [ <port_list> ] ) ]
```

show Show running system information
green-ethernet Green ethernet (Power reduction)

Default:

N/A

Usage Guide:

To display the **EVC statistics**.

Example:

To display the **EVC Red Frames** statistics for all.

```
Switch # show evc statistics all red
EVC ID  Interface                Rx Red Frames
-----  -
1       GigabitEthernet 1/1         0
1       GigabitEthernet 1/2         0
```

4.21.16 show green-ethernet

Command:

```
show green-ethernet [ interface ( <port_type> [ <port_list> ] ) ]
```

show Show running system information
green-ethernet Green ethernet (Power reduction)
interface Shows green ethernet status for a specific port or ports.

Default:

N/A

Usage Guide:

To display the **Green Ethernet** status.

Example:

To display the **Green Ethernet** status for all.

```
Switch # show green-ethernet interface *
```

4.21.17 show green-ethernet energy-detect

Command:

```
show green-ethernet energy-detect [ interface ( <port_type> [ <port_list> ] ) ]
```

show Show running system information

green-ethernet Green ethernet (Power reduction)

energy-detect Shows green ethernet energy-detect status for a specific port or ports.

interface Shows green ethernet status for a specific port or ports.

Default:

N/A

Usage Guide:

To display the **energy-detect** of **Green Ethernet**.

Example:

To display the **energy-detect** of **Green Ethernet** for all.

```
Switch # show green-ethernet energy-detect interface *
```

4.21.18 show green-ethernet short-reach

Command:

```
show green-ethernet short-reach [ interface ( <port_type> [ <port_list> ] ) ]
```

show Show running system information

green-ethernet Green ethernet (Power reduction)

short-reach Shows green ethernet short-reach status for a specific or ports

interface Shows green ethernet status for a specific port or ports.

Default:

N/A

Usage Guide:

To display the **short-reach** of **Green Ethernet**.

Example:

To display the **short-reach** of **Green Ethernet** for all.

```
Switch # show green-ethernet short-reach interface *
```

4.21.19 show history

Command:

```
show history
```

show Show running system information
history Display the session command history

Default:

N/A

Usage Guide:

To display the **command** history.

Example:

To display the **command** history.

```
Switch # show history
show green-ethernet interface GigabitEthernet 1/1
show green-ethernet interface R
show green-ethernet interface *
show green-ethernet energy-detect interface *
show green-ethernet energy-detect
show green-ethernet
show green-ethernet short-reach interface *
show history
```

4.21.20 show interface <port_type> <port_type_list> capabilities

Command:

```
show interface ( <port_type> [ <port_type_list> ] ) capabilities
```

show Show running system information
interface Interface status and configuration
switchport Show interface switchport information
capabilities Display capabilities

Default:

N/A

Usage Guide:

To display the **SFP Transceiver** information.

Example:

To display the **SFP Transceiver** information for **interface GigabitEthernet 1/1**.

```
Switch # show interface GigabitEthernet 1/1 capabilities

GigabitEthernet 1/1 Capabilities:
SFP Type: None
SFP Vendor name:
SFP Vendor PN:
SFP Vendor revision:
```

4.21.21 show interface <port_type> <port_type_list> statistics

Command:

```
show interface <port_type> <port_type_list> statistics [ { packets | bytes | errors |
discards | filtered | { priority [ <priority_v_0_to_7> ] } ] [ { up | down } ]
```

- show** Show running system information
- interface** Interface status and configuration
- statistics** Display statistics counters
- bytes** Show byte statistics.
- discards** Show discard statistics.
- down** Show ports which are down
- errors** Show error statistics.
- filtered** Show filtered statistics.
- packets** Show packet statistics.
- priority** Queue number
- up** Show ports which are up

Default:

N/A

Usage Guide:

To display the **port statistics** information.

Example:

To display the **port statistics** information (Byte statistics) for **interface GigabitEthernet 1/1**.

```
Switch # show interface GigabitEthernet 1/1 statistics bytes

Interface                Rx Octets                Tx Octets
```

```
-----
GigabitEthernet 1/1    0                0
```

4.21.22 show interface <port_type> <port_type_list> status

Command:

```
show interface <port_type> <port_type_list> status
```

show Show running system information
interface Interface status and configuration
status Display status

Default:

N/A

Usage Guide:

To display the **port status**.

Example:

To display the **port status** for interface **GigabitEthernet 1/1**.

```
Switch # show interface GigabitEthernet 1/1 status
Interface          Mode      Speed & Duplex  Max Frame  Excessive  Link
-----
GigabitEthernet 1/1  enabled   Auto            10056      Discard    Down
```

4.21.23 show interface <port_type> <port_list> switchport

Command:

```
show interface <port_type> <port_list> switchport [ access | trunk | hybrid ]
```

show Show running system information
interface Interface status and configuration
switchport Show interface switchport information
access Show access ports status
hybrid Show hybrid ports status
trunk Show trunk ports status

Default:

N/A

Usage Guide:

To display the **VLAN mode**.

Example:

To display the **VLAN mode** for interface **GigabitEthernet 1/1**.

```
Switch # show interface GigabitEthernet 1/1 switchport
Name: GigabitEthernet 1/1
Administrative mode: access
Access Mode VLAN: 1
Trunk Native Mode VLAN: 1
Administrative Native VLAN tagging: disabled
Allowed VLANs: 1-4095
Hybrid port configuration
-----
Port Type: C-Port
Acceptable Frame Type: All
Ingress filter: Disabled
Egress tagging: All except-native
Hybrid Native Mode VLAN: 1
Hybrid VLANs Enabled: 1-4095
```

4.21.24 show interface <port_type> <port_type_list> veriphy

Command:

```
show interface <port_type> <port_type_list> veriphy
```

- show** Show running system information
- interface** Interface status and configuration
- veriphy** Run cable diagnostics and show result.

Default:

N/A

Usage Guide:

To display the result of **Cable Diagnostics**.

Example:

To display the result of **Cable Diagnostics** for interface **GigabitEthernet 1/1**.

```
Switch # show interface GigabitEthernet 1/1 veriphy
Starting VeriPHY - Please wait
Interface          Pair A  Length  Pair B, Length
-----
-----
```

GigabitEthernet 1/1	OK	3	OK	3
Pair C	Length	Pair D	Length	
-----	-----	-----	-----	
OK	3	OK	3	

4.21.25 show interface <port_type> <port_type_list> veriphy

Command:

```
show interface <port_type> <port_type_list> veriphy
```

- show** Show running system information
- interface** Interface status and configuration
- veriphy** Run cable diagnostics and show result.

Default:

N/A

Usage Guide:

To display the result of **Cable Diagnostics**.

Example:

To display the result of **Cable Diagnostics** for interface **GigabitEthernet 1/1**.

```
Switch # show interface GigabitEthernet 1/1 veriphy
Starting VeriPHY - Please wait
```

Interface	Pair A	Length	Pair B, Length
-----	-----	-----	-----
GigabitEthernet 1/1	OK	3	OK 3

Pair C	Length	Pair D	Length
-----	-----	-----	-----
OK	3	OK	3

4.21.26 show interface vlan

Command:

```
show interface vlan [ <vlist> ]
```

- show** Show running system information

interface Interface status and configuration

vlan VLAN status

Default:

N/A

Usage Guide:

To display the MAC address and IP address of specific VLAN.

Example:

To display the MAC address and IP address for all VLANs.

```
Switch # show interface vlan
VLAN1
LINK: 00-30-4F-00-99-00 Mtu:1500 <UP BROADCAST RUNNING MULTICAST>
IPv4: 192.168.0.100/24 192.168.0.255
IPv6: fe80:2::201:c1ff:fe00:9900/64 <ANYCAST TENTATIVE AUTOCONF>
```

4.21.27 show ip arp

Command:

```
show ip arp
```

show Show running system information

ip Internet Protocol

arp Address Resolution Protocol

Default:

N/A

Usage Guide:

To display the **ARP table**.

Example:

To display the **ARP table** for all.

```
Switch # show ip arp
192.168.0.45 via VLAN1:d4-3d-7e-fd-e3-ac
192.168.0.78 via VLAN1:00-30-4f-97-72-2d
```

4.21.28 show ip arp inspection

Command:

```
show ip arp inspection
```

show Show running system information

ip Internet Protocol

arp Address Resolution Protocol

inspection ARP inspection

Default:

N/A

Usage Guide:

To display the **ARP Inspection Configuration**.

Example:

To display the **ARP Inspection Configuration**.

```
Switch # show ip arp inspection
```

```
ARP Inspection Mode : disabled
```

Port	Port Mode	Check VLAN	Log Type
-----	-----	-----	-----
GigabitEthernet 1/1	disabled	disabled	NONE
GigabitEthernet 1/2	disabled	disabled	NONE

4.21.29 show ip arp inspection

Command:

```
show ip arp inspection [ interface <port_type> <port_type_list> ] | vlan <vlan_list> ]
```

show Show running system information

ip Internet Protocol

arp Address Resolution Protocol

inspection ARP inspection

interface Interface status and configuration

vlan VLAN status

Default:

N/A

Usage Guide:

To display the **ARP Inspection Configuration**.

Example:

To display the **ARP Inspection Configuration**.

```
Switch # show ip arp inspection
ARP Inspection Mode : disabled

Port                Port Mode  Check VLAN  Log Type
-----
GigabitEthernet 1/1  disabled  disabled    NONE
GigabitEthernet 1/2  disabled  disabled    NONE
```

4.21.30 show ip arp inspection entry

Command:

```
show ip arp inspection entry [ dhcp-snooping | static ] [ interface ( <port_type>
[ <port_type_list> ] ) ]
```

- show** Show running system information
- ip** Internet Protocol
- arp** Address Resolution Protocol
- inspection** ARP inspection
- entry** arp inspection entries
- dhcp-snooping** learn from dhcp snooping
- static** setting from static entries
- interface** arp inspection entry interface config

Default:

N/A

Usage Guide:

To display the **ARP Inspection entry**.

Example:

To display the **ARP Inspection entry**.

```
Switch # show ip arp inspection entry
```

4.21.31 show ip dhcp detailed statistics

Command:

```
show ip dhcp detailed statistics { server | client | snooping | relay | normal-forward |
combined } [ interface ( <port_type> [ <port_list> ] ) ]
```

show Show running system information

ip Internet Protocol

dhcp Dynamic Host Configuration Protocol

detailed DHCP server

statistics Traffic statistics

client DHCP client

combined Show all DHCP related statistics

normal-forward DHCP normal L2 or L3 forward

relay DHCP relay

server DHCP server

snooping DHCP snooping

interface arp inspection entry interface config

Default:

N/A

Usage Guide:

To display the **DHCP detailed statistics**.

Example:

To display the **DHCP detailed statistics (Client) for GigabitEthernet 1/1**.

```
Switch # show ip dhcp detailed statistics client interface GigabitEthernet 1/1
GigabitEthernet 1/1 Statistics:
-----
Rx Discover:                0
Tx Discover:                0
Rx Offer:                  0
Tx Offer:                  0
Rx Request:                0
Tx Request:                0
Rx Decline:                0
Tx Decline:                0
Rx ACK:                    0
Tx ACK:                    0
```

Rx NAK:	0
Tx NAK:	0
Rx Release:	0
Tx Release:	0
Rx Inform:	0
Tx Inform:	0
Rx Lease Query:	0
Tx Lease Query:	0
Rx Lease Unassigned:	0
Tx Lease Unassigned:	0
Rx Lease Unknown:	0
Tx Lease Unknown:	0
Rx Lease Active:	0
Tx Lease Active:	0
Rx Lease Active:	0
Tx Lease Active:	0
Rx Discarded checksum error:	0

4.21.32 show ip dhcp excluded-address

Command:

```
show ip dhcp excluded-address
```

- show** Show running system information
- ip** Internet Protocol
- dhcp** Dynamic Host Configuration Protocol
- excluded-address** Excluded IP database

Default:

N/A

Usage Guide:

To display the **excluded IP range**.

Example:

To display the **excluded IP range**.

```
Switch # show ip dhcp excluded-address

Low Address      High Address
-----
```

01	192.168.0.100	192.168.0.101
----	---------------	---------------

4.21.33 show ip dhcp pool

Command:

```
show ip dhcp pool [ <pool_name> ]
```

show Show running system information
ip Internet Protocol
dhcp Dynamic Host Configuration Protocol
pool DHCP pools information

Default:

N/A

Usage Guide:

To display the **DHCP pools** information.

Example:

To display the **DHCP pools** information.

```
Switch # show ip dhcp pool

Pool Name: test
-----
Type is network
IP is 192.168.1.100
Subnet mask is 255.255.255.0
Subnet broadcast address is -
Lease time is 1 days 0 hours 0 minutes
Default router is 192.168.1.1
Domain name is -
DNS servers are 168.95.1.1 8.8.8.8
NTP server is -
Netbios name server is -
Netbios node type is -
Netbios scope identifier is -
NIS domain name is -
NIS server is -
Vendor class information is -
Client identifier is -
Hardware address is -
```

Client name is -

4.21.34 show ip dhcp relay

Command:

```
show ip dhcp relay [ statistics ]
```

show Show running system information
ip Internet Protocol
dhcp Dynamic Host Configuration Protocol
relay DHCP relay agent configuration
statistics Traffic statistics

Default:

N/A

Usage Guide:

To display the **DHCP relay** information.

Example:

To display the **DHCP relay** information.

```
Switch # show ip dhcp relay
Switch DHCP relay mode is enabled
Switch DHCP relay server address is 192.168.0.76
Switch DHCP relay information option is enabled
Switch DHCP relay information policy is keep
```

4.21.35 show ip dhcp server

Command:

```
show ip dhcp server
```

show Show running system information
ip Internet Protocol
dhcp Dynamic Host Configuration Protocol
server DHCP server information

Default:

N/A

Usage Guide:

To display the **DHCP Server Mode Configuration**.

Example:

To display the **DHCP Server Mode Configuration**.

```
Switch # show ip dhcp server

DHCP server is globally disabled.

All VLANs are disabled.
```

4.21.36 show ip dhcp server binding (GG)

Command:

```
show ip dhcp server binding [ state { allocated | committed | expired } ] [ type
{ automatic | manual | expired } ] [ <ip> ]
```

- show** Show running system information
- ip** Internet Protocol
- dhcp** Dynamic Host Configuration Protocol
- server** DHCP server information
- binding** DHCP address bindings
- state** State of binding
- allocated** Allocated state
- committed** Committed state
- expired** Expired state
- type** Type of binding
- automatic** Automatic binding with infinite lease time
- expired** Expired binding that is aged out
- manual** Manual binding for a specific host
- <ip>** IP address in dotted-decimal notation

Default:

N/A

Usage Guide:

To display the **DHCP Server binding configuration**.

Example:

To display the **DHCP Server binding configuration**.

```
Switch # show ip dhcp server binding
```

4.21.37 show ip dhcp server declined-ip (GG)

Command:

```
show ip dhcp server declined-ip
```

show Show running system information
ip Internet Protocol
dhcp Dynamic Host Configuration Protocol
server DHCP server information
declined-ip Declined IP address

Default:

N/A

Usage Guide:

To display the **DHCP Decline** information.

Example:

To display the **DHCP Decline** information.

```
Switch # show ip dhcp server declined-ip
```

4.21.38 show ip dhcp server statistics

Command:

```
show ip dhcp server statistics
```

show Show running system information
ip Internet Protocol
dhcp Dynamic Host Configuration Protocol
server DHCP server information
statistics DHCP server statistics

Default:

N/A

Usage Guide:

To display the **DHCP Server** statistics.

Example:

To display the **DHCP Server** statistics.

```

Switch # show ip dhcp server statistics

Database Counters
=====
POOL                2
Excluded IP        1
Declined IP        0
=====

Binding Counters
=====
Automatic          0
Manual             0
Expired            0
=====

Message Received Counters
=====
DISCOVER           0
REQUEST            0
DECLINE            0
RELEASE            0
INFORM             0
=====

Message Sent Counters
=====
OFFER              0
ACK                0
NAK                0
=====
    
```

4.21.39 show ip dhcp snooping

Command:

```
show ip dhcp snooping [interface ( <port_type> [ <port_list> ] )]
```

show Show running system information

ip Internet Protocol

dhcp Dynamic Host Configuration Protocol
snooping DHCP snooping
interface Select an interface to configure

Default:

N/A

Usage Guide:

To display the **DHCP Snooping** configuration.

Example:

To display the **DHCP Snooping** configuration for **GigabitEthernet 1/1**.

```
Switch # show ip dhcp snooping interface GigabitEthernet 1/1
GigabitEthernet 1/1 untrusted
```

4.21.40 show ip dhcp snooping table

Command:

```
show ip dhcp snooping table
```

show Show running system information
ip Internet Protocol
dhcp Dynamic Host Configuration Protocol
snooping DHCP snooping
table show ip dhcp snooping table

Default:

N/A

Usage Guide:

To display the **DHCP Snooping** table.

Example:

To display the **DHCP Snooping** table.

```
Switch # show ip dhcp snooping table
```

4.21.41 show ip http server secure status

Command:

```
show ip http server secure status
```

show Show running system information
ip Internet Protocol
http Hypertext Transfer Protocol
server HTTP web server
secure Secure
status Status

Default:

N/A

Usage Guide:

To display the **DHCP Snooping** table.

Example:

To display the **DHCP Snooping** table.

```
Switch # show ip http server secure status
Switch secure HTTP web server is disabled
Switch secure HTTP web redirection is disabled
```

4.21.42 show ip igmp snooping

Command:

```
show ip igmp snooping [ vlan <vlan_list> ] [ group-database [ interface ( <port_type>
[ <port_type_list> ] ) ] [ sfm-information ] ] [ detail ]
```

show Show running system information
ip Internet Protocol
igmp Internet Group Management Protocol
snooping Snooping IGMP
vlan Search by VLAN
group-database Multicast group database from IGMP
interface Search by port
sfm-information Including source filter multicast information from IGMP
detail Detail running information/statistics of IGMP snooping

Default:

N/A

Usage Guide:

To display the **IGMP Snooping** information.

Example:

To display the **IGMP Snooping** information (Detail).

```
Switch # show ip igmp snooping detail

IGMP Snooping is disabled to stop snooping IGMP control plane.
Multicast streams destined to unregistered IGMP groups will be flooding.
```

4.21.43 show ip igmp snooping mrouter

Command:

```
show ip igmp snooping mrouter [ detail ]
```

- show** Show running system information
- ip** Internet Protocol
- igmp** Internet Group Management Protocol
- snooping** Snooping IGMP
- mrouter** Multicast router port status in IGMP
- detail** Detail running information/statistics of IGMP snooping

Default:

N/A

Usage Guide:

To display the **IGMP Router Port** information.

Example:

To display the **IGMP Router Port** information.

```
Switch # show ip igmp snooping mrouter

IGMP Snooping is disabled to stop snooping IGMP control plane.

Switch-1 IGMP Router Port Status
Gi 1/1: Static and Dynamic Router Port
```

4.21.44 show ip interface brief

Command:

```
show ip interface brief
```

show Show running system information
ip Internet Protocol
interface IP interface status and configuration
brief Brief IP interface status

Default:

N/A

Usage Guide:

To display the **IP interface status**.

Example:

To display the **IP interface status**.

```
Switch # show ip interface brief
Vlan Address          Method  Status
-----
1 192.168.0.100/24    Manual  UP
```

4.21.45 show ip name-server

Command:

```
show ip name-server
```

show Show running system information
ip Internet Protocol
name-server Domain Name System

Default:

N/A

Usage Guide:

To display the **DNS Server** information.

Example:

To display the **DNS Server** information.

```
Switch # show ip name-server
```

```
Current DNS server is 8.8.8.8 set by STATIC.
```

4.21.46 show ip route

Command:

```
show ip route
```

show Show running system information
ip Internet Protocol
route Display the current ip routing table

Default:

N/A

Usage Guide:

To display the **IP Routing table**.

Example:

To display the **IP Routing table**.

```
Switch # show ip route
11.11.11.0/24 via 192.168.0.14 <UP GATEWAY HW_RT>
127.0.0.1/32 via 127.0.0.1 <UP HOST>
192.168.0.0/24 via VLAN1 <UP HW_RT>
224.0.0.0/4 via 127.0.0.1 <UP>
```

4.21.47 show ip source binding

Command:

```
show ip source binding [ dhcp-snooping | static ] [ interface ( <port_type>
[ <port_type_list> ] ) ]
```

show Show running system information
ip Internet Protocol
source source command
binding ip source binding
dhcp-snooping learn from dhcp snooping
interface ip source binding interface config
static setting from static entries

Default:

N/A

Usage Guide:To display the **Static IP Source Guard Table**.**Example:**To display the **Static IP Source Guard Table**.

```
Switch # show ip source binding interface GigabitEthernet 1/1
```

Type	Port	VLAN	IP Address	IP Mask
----	----	----	-----	-----
Static	GigabitEthernet 1/1	1	192.168.0.22	255.255.255.0

4.21.48 show ip ssh

Command:

```
show ip ssh
```

show Show running system information**ip** Internet Protocol**ssh** Secure Shell**Default:**

N/A

Usage Guide:To display the **SSH Management** status.**Example:**To display the **SSH Management** status.

```
Switch # show ip ssh
Switch SSH is enabled
```

4.21.49 show ip statistics

Command:

```
show ip statistics
```

show Show running system information**ip** Internet Protocol**statistics** Traffic statistics

Default:

N/A

Usage Guide:

To display the **IP statistics**.

Example:

To display the **IP statistics**.

```
Switch # show ip statistics

IPv4 statistics:

Rcvd: 9751 total in 1454882 bytes
      9606 local destination, 0 forwarding
      0 header error, 0 address error, 0 unknown protocol
      0 no route, 0 truncated, 145 discarded
Sent: 8087 total in 2703484 bytes
      8087 generated, 0 forwarded
      0 no route, 0 discarded
Frag: 0 reassemble (0 reassembled, 0 couldn't reassemble)
      0 fragment (0 fragmented, 0 couldn't fragment)
      0 fragment created
Mcast: 913 received in 99661 bytes
       0 sent in 0 byte
Bcast: 768 received, 0 sent

IP interface statistics:

IPv4 Statistics on Interface VLAN: 1
Rcvd: 9751 total in 1454882 bytes
      9606 local destination, 0 forwarding
      0 header error, 0 address error, 0 unknown protocol
      0 no route, 0 truncated, 145 discarded
Sent: 8087 total in 2703484 bytes
      8087 generated, 0 forwarded
      0 discarded
Frag: 0 reassemble (0 reassembled, 0 couldn't reassemble)
      0 fragment (0 fragmented, 0 couldn't fragment)
      0 fragment created
Mcast: 913 received in 99661 bytes
       0 sent in 0 byte
```

```

Bcast: 768 received, 0 sent

IPv4 ICMP statistics:

Rcvd: 2618 Messages, 0 Error
Sent: 2618 Messages, 0 Error

ICMP message statistics:

IPv4 ICMP Message: Echo Reply
Rcvd: 0 Packet
Sent: 2618 Packets
IPv4 ICMP Message: Echo
Rcvd: 2618 Packets
Sent: 0 Packet
    
```

4.21.50 show ip verify source

Command:

```

show ip verify source [ interface ( <port_type> [ <port_type_list> ] ) ]
    
```

- show** Show running system information
- ip** Internet Protocol
- verify** verify command
- source** verify source
- interface** ip verify source interface config

Default:

N/A

Usage Guide:

To display the **IP Source Guard** configuration.

Example:

To display the **IP Source Guard** configuration for **GigabitEthernet 1/1**.

```

Switch # show ip verify source interface GigabitEthernet 1/1

Port                Port Mode      Dynamic Entry Limit
----                -
GigabitEthernet 1/1  enabled        1
    
```

4.21.51 show ipmc profile

Command:

```
show ipmc profile [ <profile_name> ] [ detail ]
```

show Show running system information
ipmc IPv4/IPv6 multicast configuration
profile IPMC profile configuration
<ProfileName : word16> Profile name
detail Detail information of a profile

Default:

N/A

Usage Guide:

To display the **IP Multicast Profile**.

Example:

To display the **IP Multicast Profile**.

```
Switch # show ipmc profile

IPMC Profile is now enabled to start filtering.

Profile: 1 (In VER-INI Mode)
Description: test
```

4.21.52 show ipmc range

Command:

```
show ipmc range [ <entry_name> ]
```

show Show running system information
ipmc IPv4/IPv6 multicast configuration
range A range of IPv4/IPv6 multicast addresses for the profile
<EntryName : word16> Range entry name

Default:

N/A

Usage Guide:

To display the **IP Multicast Range**.

Example:

To display the **IP Multicast Range**.

```
Switch # show ipmc range

Range Name      : 1
Start Address: 224.24.24.24
End Address   : 224.24.24.25
```

4.21.53 show ipv6 interface

Command:

```
show ipv6 interface [ vlan <vlan_list> { brief | statistics } ]
```

- show** Show running system information
- ipv6** IPv6 configuration commands
- vlan** VLAN of IPv6 interface
- brief** Brief summary of IPv6 status and configuration
- statistics** Traffic statistics

Default:

N/A

Usage Guide:

To display the **IPv6 configuration**.

Example:

To display the **IPv6 configuration**.

```
Switch # show ipv6 interface

IPv6 Vlan1 interface is up.
Internet address is 2001::7766
Internet address is fe80::201:c1ff:fe00:9900
Static address is 2001::7766/64
IP stack index (IFID) is 2
Routing is enabled on this interface
MTU is 1500 bytes

IPv6 Statistics on Interface VLAN: 1
```

```

Rcvd: 3 total in 168 bytes
      3 local destination, 0 forwarding
      0 header error, 0 address error, 0 unknown protocol
      0 no route, 0 truncated, 0 discarded

Sent: 17 total in 1104 bytes
      17 generated, 0 forwarded
      0 discarded

Frag: 0 reassemble (0 reassembled, 0 couldn't reassemble)
      0 fragment (0 fragmented, 0 couldn't fragment)
      0 fragment created

Mcast: 3 received in 168 bytes
       17 sent in 1104 bytes

Bcast: 0 received, 0 sent
    
```

4.21.54 show ipv6 mld snooping

Command:

```

show ipv6 mld snooping [ vlan <vlan_list> ] [ group-database [ interface
( <port_type> [ <port_type_list> ] ) ] [ sfm-information ] ] [ detail ]
    
```

- show** Show running system information
- ipv6** IPv6 configuration commands
- mld** Multicast Listener Discovery
- snooping** Snooping MLD
- vlan** Search by VLAN
- group-database** Multicast group database from MLD
- interface** Search by port
- sfm-information** Including source filter multicast information from MLD
- detail** Detail running information/statistics of MLD snooping

Default:

N/A

Usage Guide:

To display the **MLD Snooping** information.

Example:

To display the **MLD Snooping** information (Detail).

```

Switch # show ipv6 mld snooping detail
    
```

MLD Snooping is disabled to stop snooping MLD control plane.
 Multicast streams destined to unregistered MLD groups will be flooding.

4.21.55 show ipv6 mld snooping mrouter

Command:

show ip igmp snooping mrouter [detail]

show Show running system information
ipv6 IPv6 configuration commands
mld Multicast Listener Discovery
snooping Snooping MLD
mrouter Multicast router port status in MLD
detail Detail running information/statistics of MLD snooping

Default:

N/A

Usage Guide:

To display the **MLD Router Port** information.

Example:

To display the **MLD Router Port** information.

```
Switch # show ipv6 mld snooping mrouter

MLD Snooping is enabled to start snooping MLD control plane.

Switch-1 MLD Router Port Status
Gi 1/1: Static and Dynamic Router Port
```

4.21.56 show ipv6 neighbor

Command:

show ipv6 neighbor [interface vlan <vlan_list>]

show Show running system information
ipv6 IPv6 configuration commands
neighbor IPv6 neighbors
interface Select an interface to configure
vlan VLAN of IPv6 interface

Default:

N/A

Usage Guide:To display the **IPv6 neighbor** information.**Example:**To display the **IPv6 neighbor** information.

```
Switch # show ipv6 neighbor

2001::7766 via VLAN1: 00-30-4F-00-99-00 Permanent/REACHABLE
fe80::201:c1ff:fe00:9900 via VLAN1: 00-30-4F-00-99-00 Permanent/REACHABLE
```

4.21.57 show ipv6 route

Command:

```
show ipv6 route [ interface vlan <vlan_list> ]
```

show Show running system information
ipv6 IPv6 configuration commands
route IPv6 routes
interface Select an interface to configure
vlan VLAN of IPv6 interface

Default:

N/A

Usage Guide:To display the **IPv6 Routing table**.**Example:**To display the **IPv6 Routing table**.

```
Switch # show ipv6 route

::1/128 via ::1 <UP HOST>
2001::/64 via VLAN1 <UP HW_RT>
2001::7766/128 via 1:c100:9900:: <UP HOST>
2002::/64 via 2001::7788 <UP GATEWAY HW_RT>
```

4.21.58 show ipv6 statistics

Command:

```
show ipv6 statistics [ system ] [ interface vlan <vlan_list> ] [ icmp ] [ icmp-msg
<type> ]
```

show Show running system information

ipv6 IPv6 configuration commands

statistics Traffic statistics

icmp IPv6 ICMP traffic

icmp-msg IPv6 ICMP traffic for designated message type

<Type : 0~255> ICMP message type ranges from 0 to 255

interface Select an interface to configure

vlan IPv6 interface traffic

system IPv6 system traffic

Default:

N/A

Usage Guide:

To display the **IPv6 statistics**.

Example:

To display the **IPv6 statistics**.

```
Switch # show ipv6 statistics

IPv6 statistics:

Rcvd: 24 total in 2064 bytes
      6 local destination, 0 forwarding
      0 header error, 0 address error, 0 unknown protocol
      0 no route, 0 truncated, 18 discarded

Sent: 34 total in 2208 bytes
      38 generated, 0 forwarded
      0 no route, 0 discarded

Frag: 0 reassemble (0 reassembled, 0 couldn't reassemble)
      0 fragment (0 fragmented, 0 couldn't fragment)
      0 fragment created
```

Mcast: 24 received in 2064 bytes

34 sent in 2208 bytes

Bcast: 0 received, 0 sent

IP interface statistics:

IPv6 Statistics on Interface VLAN: 1

Rcvd: 12 total in 1032 bytes

3 local destination, 0 forwarding

0 header error, 0 address error, 0 unknown protocol

0 no route, 0 truncated, 9 discarded

Sent: 17 total in 1104 bytes

17 generated, 0 forwarded

0 discarded

Frag: 0 reassemble (0 reassembled, 0 couldn't reassemble)

0 fragment (0 fragmented, 0 couldn't fragment)

0 fragment created

Mcast: 12 received in 1032 bytes

17 sent in 1104 bytes

Bcast: 0 received, 0 sent

IPv6 ICMP statistics:

Rcvd: 3 Messages, 0 Error

Sent: 19 Messages, 0 Error

ICMP message statistics:

IPv6 ICMP Message: Multicast Listener Report

Rcvd: 0 Packet

Sent: 10 Packets

IPv6 ICMP Message: Router Solicitation (NDP)

Rcvd: 3 Packets

Sent: 6 Packets

IPv6 ICMP Message: Neighbor Solicitation (NDP)

Rcvd: 0 Packet

Sent: 3 Packets

4.21.59 show lacp

Command:

```
show lacp { internal | statistics | system-id | neighbour }
```

show Show running system information
lacp LACP configuration/status
internal Internal LACP configuration
neighbour Neighbour LACP status
statistics Internal LACP statistics
system-id LACP system id

Default:

N/A

Usage Guide:

To display the **LACP mode** information.

Example:

To display the **LACP mode** information.

```
Switch # show lacp internal
Port                Mode   Key   Role   Timeout Priority
-----
Gi 1/1              Enabled Auto  Active Fast    32768
Gi 1/2              Enabled Auto  Active Fast    32768
Gi 1/3              Disabled Auto  Active Fast    32768
```

4.21.60 show line

Command:

```
show line [ alive ]
```

show Show running system information
line TTY line information
alive Display information about alive lines

Default:

N/A

Usage Guide:To display the **VTY** information.**Example:**To display the **VTY** information.

```

Switch # show line alive
Line is con 0.
  * You are at this line now.
  Alive from Console.
  Default privileged level is 2.
  Command line editing is enabled
  Display EXEC banner is enabled.
  Display Day banner is enabled.
  Terminal width is 80.
    length is 24.
    history size is 32.
    exec-timeout is 10 min 0 second.

  Current session privilege is 15.
  Elapsed time is 0 day 0 hour 17 min 20 sec.
  Idle time is 0 day 0 hour 0 min 0 sec.

```

4.21.61 show lldp med media-vlan-policy

Command:

```
show lldp med media-vlan-policy [<0~31>]
```

show Show running system information
lldp Display LLDP neighbors information
med Display LLDP-MED neighbors information
media-vlan-policy Display media vlan policies
<0~31> List of policies

Default:

N/A

Usage Guide:To display the **LLDP-MED policy** information.**Example:**To display the **LLDP-MED policy** information.

```
Switch # show lldp med media-vlan-policy
```

Policy Id	Application Type	Tag	Vlan ID	L2 Priority	DSCP
0	Voice	Tagged	1	0	0

4.21.62 show lldp med remote-device

Command:

```
show lldp med remote-device [ interface ( <port_type> [ <port_list> ] ) ]
```

show Show running system information

lldp Display LLDP neighbors information

med Display LLDP-MED neighbors information

remote-device Display remote device LLDP-MED neighbors information

interface Interface to display

Default:

N/A

Usage Guide:

To display the **LLDP-MED entries** information.

Example:

To display the **LLDP-MED entries** information.

```
Switch # show lldp med remote-device
```

```
No LLDP-MED entries found
```

4.21.63 show lldp neighbors

Command:

```
show lldp neighbors [ interface ( <port_type> [ <port_type_list> ] ) ]
```

show Show running system information

lldp Display LLDP neighbors information

neighbors Display LLDP neighbors information

interface Interface to display

Default:

N/A

Usage Guide:

To display the **LLDP neighbors** information.

Example:

To display the **LLDP neighbors** information.

```
Switch # show lldp neighbors
No LLDP entries found
```

4.21.64 show lldp statistics

Command:

```
show lldp statistics [ interface ( <port_type> [ <port_type_list> ] ) ]
```

- show** Show running system information
- lldp** Display LLDP neighbors information
- statistics** Display LLDP statistics information
- interface** Interface to display

Default:

N/A

Usage Guide:

To display the **LLDP statistics** information.

Example:

To display the **LLDP statistics** information for **GigabitEthernet 1/1**.

```
Switch # show lldp statistics interface GigabitEthernet 1/1
```

Interface	Rx Frames	Tx Frames	Rx Errors
-----	-----	-----	-----
GigabitEthernet 1/1	0	3030	0

Rx Discards	Rx TLV Errors	Rx TLV Unknown	Rx TLV Organiz.	Rx TLV Aged
-----	-----	-----	-----	-----
0	0	0	0	0

4.21.65 show logging

Command:

```
show logging {<log_id> | error | info | warning } [ switch <switch_list> ]
```

- show** Show running system information
- logging** Syslog
- <logging_id: 1-4294967295>** Logging ID

switch Switch
<switch_list> Switch ID list in 1

Default:

N/A

Usage Guide:

To display the **Syslog** information.

Example:

To display the **Syslog** information with Log ID 235861.

```
Switch # show logging 235861
Switch : 1
ID      : 235861
Level   : Warning
Time    : 1970-01-01T13:33:57+00:00
Message:
Loop Detected: Port 5 shut down
```

4.21.66 show loop-protect

Command:

```
show loop-protect [ interface ( <port_type> [ <port_list> ] ) ]
```

show Show running system information
loop-protect Loop protection configuration
interface Interface status and configuration

Default:

N/A

Usage Guide:

To display the **Loop protection** information.

Example:

To display the **Loop protection** information for **GigabitEthernet 1/1**.

```
Switch # show loop-protect interface GigabitEthernet 1/1

Loop Protection Configuration
=====
Loop Protection   : Enable
Transmission Time : 2 sec
Shutdown Time    : 2 sec
```

GigabitEthernet 1/1

Loop protect mode is enabled.
 Actions are both of shutdown and log.
 Transmit mode is enabled.
 No loop.
 The number of loops is 12390.
 Time of last loop is at 1970-01-01T14:58:28+00:00
 Status is down.

4.21.67 show mac address-table

Command:

```
show mac address-table [ conf | static | aging-time | { { learning | count } [ interface
( <port_type> [ <port_type_list> ] ) ] } | { address <mac_addr> [ vlan <vlan_id> ] } |
vlan <vlan_id_1> | interface ( <port_type> [ <port_type_list> ] ) ]
```

show Show running system information
mac MAC Address Table information
address-table MAC Address Table
address MAC address lookup
aging-time Aging time
conf User added static MAC addresses
count Total number of MAC addresses
interface Select an interface to configure
learning Learn/disable/secure state
static All static MAC addresses
vlan Addresses in this VLAN

Default:

N/A

Usage Guide:

To display the **MAC address table**.

Example:

To display the **MAC address table** for **VLAN 1**.

```
Switch # show mac address-table vlan 1
Type   VID  MAC Address      Ports
```



```

Static 1 33:33:00:00:00:01 GigabitEthernet 1/1-25 10GigabitEthernet 1/1-4 CPU
Static 1 33:33:00:00:00:02 GigabitEthernet 1/1-25 10GigabitEthernet 1/1-4 CPU
Static 1 33:33:ff:00:99:00 GigabitEthernet 1/1-25 10GigabitEthernet 1/1-4 CPU
Dynamic 1 d4:3d:7e:fd:e3:ac GigabitEthernet 1/21
Static 1 ff:ff:ff:ff:ff GigabitEthernet 1/1-25 10GigabitEthernet 1/1-4 CPU
    
```

4.21.68 show mep

Command:

```

show mep [ <instance> ] [ peer | cc | lm | dm | lt | lb | tst | aps | client | ais | lck ]
[ detail ]
    
```

show Show running system information

mep Maintenance Entity Point

<instance> The range of MEP instances

ais Show AIS state

aps Show APS state

cc Show CC state

client Show Client state

detail Show detailed state including configuration information.

dm Show DM state

lb Show LB state

lck Show LCK state

lm Show LM state

lt Show LT state

peer Show peer mep state

tst Show TST state

Default:

N/A

Usage Guide:

To display the **MEP** information.

Example:

To display the **MEP instance 1** information.

```

Switch # show mep 1
    
```

```

MEP state is:
    
```

```

Inst cLevel cMeg cMep cAis cLck cSsf aBlk aTsf
  1 False False False False False True False True
    
```

4.21.69 show mvr

Command:

```
show mvr [ vlan <vlan_list> | name <mvr_name> ] [ group-database [ interface
( <port_type> [ <port_type_list> ] ) ] [ sfm-information ] ] [ detail ]
```

show Show running system information

mvr Multicast VLAN Registration configuration

name Search by MVR name

vlan Search by VLAN

group-database Multicast group database from MVR

interface Search by port

sfm-information Including source filter multicast information from MVR

detail Detail information/statistics of MVR group database

Default:

N/A

Usage Guide:

To display the **MVR** information.

Example:

To display the **MVR** information.

```
Switch # show mvr

MVR is now enabled to start group registration.

Switch-1 MVR-IGMP Interface Status

IGMP MVR VLAN 1 (Name is 1) interface is enabled.
Querier status is IDLE
RX IGMP Query:0 V1Join:0 V2Join:0 V3Join:0 V2Leave:0
TX IGMP Query:0 / (Source) Specific Query:0
Interface Channel Profile: <No Associated Profile>

Switch-1 MVR-MLD Interface Status
```

```
MLD MVR VLAN 1 (Name is 1) interface is enabled.
Querier status is IDLE
RX MLD Query:0 V1Report:0 V2Report:0 V1Done:0
TX MLD Query:0 / (Source) Specific Query:0
Interface Channel Profile: <No Associated Profile>
```

4.21.70 show network-clock

Command:

```
show network-clock
```

show Show running system information
network-clock Show selector state

Default:

N/A

Usage Guide:

To display the **SyncE** information.

Example:

To display the **SyncE** information.

```
Switch # show network-clock

Selector State is: Free Run

Alarm State is:
Clk:      1      2
LOCS:    FALSE  FALSE
SSM:     FALSE  FALSE
WTR:     FALSE  FALSE

LOL:     FALSE
DHOLD:   TRUE

SSM State is:
Interface          Tx SSM      Rx SSM Mode
GigabitEthernet 1/1  QL_NONE    QL_LINK Master
```

4.21.71 show ntp status

Command:

```
show ntp status
```

show Show running system information

ntp Configure NTP

status status

Default:

N/A

Usage Guide:

To display the **NTP Server** information.

Example:

To display the **NTP Server** information.

```
Switch # show ntp status
NTP Mode : enabled
Idx  Server IP host address (a.b.c.d) or a host name string
---  -----
1    192.168.0.44
2
3
4
5
```

4.21.72 show platform phy

Command:

```
show platform phy [ interface ( <port_type> [ <port_type_list> ] ) ]
```

show Show running system information

platform Platform specific information

phy PHYs' information

interface Search by port

Default:

N/A

Usage Guide:

To display the **PHY** information.

Example:

To display the **PHY** information for **GigabitEthernet 1/1**.

```
Switch # show platform phy interface GigabitEthernet 1/1
```

Port	API Inst	WAN/LAN/1G	Mode	Duplex	Speed	Link
---	-----	-----	---	-----	-----	---
1	Default	1G	ANEG	-	-	No

4.21.73 show platform phy failover

Command:

```
show platform phy failover
```

- show** Show running system information
- platform** Platform specific information
- phy** PHYs' information
- failover** Failover status

Default:

N/A

Usage Guide:

To display the **PHY** failover status.

Example:

To display the **PHY** failover status.

```
Switch # show platform phy failover
```

Port	Active	Channel	Broadcast	After reset
---	-----	-----	-----	-----

4.21.74 show platform phy id

Command:

```
show platform phy id [ interface ( <port_type> [ <port_type_list> ] ) ]
```

- show** Show running system information
- platform** Platform specific information
- phy** PHYs' information
- id** id
- interface** Search by port

Default:

N/A

Usage Guide:

To display the **PHY** ID.

Example:

To display the **PHY** ID for **GigabitEthernet 1/1**.

```
Switch # show platform phy id interface GigabitEthernet 1/1
```

Port	Channel	API Base	Phy Id	Phy Rev.
---	-----	-----	-----	-----
1	0	0 (1g)	8634	0

4.21.75 show platform phy status

Command:

```
show platform phy status [ interface ( <port_type> [ <v_port_type_list> ] ) ]
```

- show** Show running system information
- platform** Platform specific information
- phy** PHYs' information
- status** status
- interface** Search by port

Default:

N/A

Usage Guide:

To display the **PHY** status.

Example:

To display the **PHY** status.

```
Switch # show platform phy status interface GigabitEthernet 1/1
```

Port	Issues seen during 1G PHY warmstart	Issues during 10G PHY WS
---	-----	-----
1	No	No

4.21.76 show port-security port

Command:

```
show port-security port [ interface ( <port_type> [ <port_type_list> ] ) ]
```

show Show running system information
port-security port-security
port Show MAC Addresses learned by Port Security
interface Search by port

Default:

N/A

Usage Guide:

To display the **MAC Addresses** of **Port Security**.

Example:

To display the **MAC Addresses** of **Port Security**.

```
Switch # show port-security port interface GigabitEthernet 1/1
GigabitEthernet 1/1
-----
MAC Address      VID   State   Added                               Age/Hold Time
-----
<none>
```

4.21.77 show port-security switch

Command:

```
show port-security switch [ interface ( <port_type> [ <port_type_list> ] ) ]
```

show Show running system information
port-security port-security
switch Show Port Security status
interface Search by port

Default:

N/A

Usage Guide:

To display the status of **Port Security**.

Example:

To display the status of **Port Security**.

```
Switch # show port-security switch interface GigabitEthernet 1/1
Users:
L = Limit Control
```

8 = 802.1X

D = DHCP Snooping

V = Voice VLAN

Interface	Users	State	MAC Cnt
-----	----	-----	-----
GigabitEthernet 1/1	----	No users	0

4.21.78 show privilege

Command:

```
show privilege
```

show Show running system information

privilege Display command privilege

Default:

N/A

Usage Guide:

To display the **Privilege** information.

Example:

To display the **Privilege** information.

```
Switch # show privilege
```

4.21.79 show pvlan

Command:

```
show pvlan [ <pvlan_list> ]
```

show Show running system information

pvlan PVLAN configuration

Default:

N/A

Usage Guide:

To display the Private VLAN membership configuration.

Example:

To display the Private VLAN membership configuration for all VLANs.

```
Switch # show pvlan
PVLAN ID  Ports
-----  -----
1         GigabitEthernet 1/1, GigabitEthernet 1/2, GigabitEthernet 1/3,
```

4.21.80 show pvlan isolation

Command:

```
show pvlan isolation [ interface ( <port_type> [ <port_list> ] ) ]
```

- show** Show running system information
- pvlan** PVLAN configuration
- isolation** show isolation configuration
- interface** Search by port

Default:

N/A

Usage Guide:

To display the port isolation configuration.

Example:

To display the port isolation configuration.

```
Switch # show pvlan isolation
Port                               Isolation
-----                               -
GigabitEthernet 1/1                Disabled
GigabitEthernet 1/2                Disabled
GigabitEthernet 1/3                Disabled
```

4.21.81 show qos

Command:

```
show qos [ { interface [ ( <port_type> [ <port> ] ) ] } | wred | { maps [ dscp-cos ]
[ dscp-ingress-translation ] [ dscp-classify ] [ cos-dscp ] [ dscp-egress-translation ] }
| { qce [ <qce> ] } ]
```

- show** Show running system information
- qos** Quality of Service

interface	Interface
maps	Global QoS Maps/Tables
cos-dscp	Map for cos to dscp
dscp-classify	Map for dscp classify enable
dscp-cos	Map for dscp to cos
dscp-egress-translation	Map for dscp egress translation
dscp-ingress-translation	Map for dscp ingress translation
qce	QoS Control Entry
<qce>	QCE ID
wred	Weighted Random Early Discard

Default:

N/A

Usage Guide:

To display the **QoS** configuration.

Example:

To display the **QoS** configuration for **GigabitEthernet 1/1**.

```
Switch # show qos interface GigabitEthernet 1/1
interface GigabitEthernet 1/1
  qos cos 0
  qos pcp 0
  qos dpl 0
  qos dei 0
  qos trust tag disabled
  qos map tag-cos pcp 0 dei 0 cos 1 dpl 0
  qos map tag-cos pcp 0 dei 1 cos 1 dpl 1
  qos map tag-cos pcp 1 dei 0 cos 0 dpl 0
  qos map tag-cos pcp 1 dei 1 cos 0 dpl 1
  qos map tag-cos pcp 2 dei 0 cos 2 dpl 0
  qos map tag-cos pcp 2 dei 1 cos 2 dpl 1
  qos map tag-cos pcp 3 dei 0 cos 3 dpl 0
  qos map tag-cos pcp 3 dei 1 cos 3 dpl 1
  qos map tag-cos pcp 4 dei 0 cos 4 dpl 0
  qos map tag-cos pcp 4 dei 1 cos 4 dpl 1
  qos map tag-cos pcp 5 dei 0 cos 5 dpl 0
  qos map tag-cos pcp 5 dei 1 cos 5 dpl 1
  qos map tag-cos pcp 6 dei 0 cos 6 dpl 0
  qos map tag-cos pcp 6 dei 1 cos 6 dpl 1
  qos map tag-cos pcp 7 dei 0 cos 7 dpl 0
  qos map tag-cos pcp 7 dei 1 cos 7 dpl 1
  qos trust dscp disabled
```

```
qos policer mode: disabled, rate: 500 kbps
qos queue-policer queue 0 mode: disabled, rate: 500 kbps
qos queue-policer queue 1 mode: disabled, rate: 500 kbps
qos queue-policer queue 2 mode: disabled, rate: 500 kbps
qos queue-policer queue 3 mode: disabled, rate: 500 kbps
qos queue-policer queue 4 mode: disabled, rate: 500 kbps
qos queue-policer queue 5 mode: disabled, rate: 500 kbps
qos queue-policer queue 6 mode: disabled, rate: 500 kbps
qos queue-policer queue 7 mode: disabled, rate: 500 kbps
qos shaper mode: disabled, rate: 500 kbps
qos queue-shaper queue 0 mode: disabled, rate: 500 kbps, excess: disabled
qos queue-shaper queue 1 mode: disabled, rate: 500 kbps, excess: disabled
qos queue-shaper queue 2 mode: disabled, rate: 500 kbps, excess: disabled
qos queue-shaper queue 3 mode: disabled, rate: 500 kbps, excess: disabled
qos queue-shaper queue 4 mode: disabled, rate: 500 kbps, excess: disabled
qos queue-shaper queue 5 mode: disabled, rate: 500 kbps, excess: disabled
qos queue-shaper queue 6 mode: disabled, rate: 500 kbps, excess: disabled
qos queue-shaper queue 7 mode: disabled, rate: 500 kbps, excess: disabled
qos wrr mode: disabled, weight: q0:17 q1:17 q2:17 q3:17 q4:17 q5:17
qos tag-remark classified
qos map cos-tag cos 0 dpl 0 pcp 1 dei 0
qos map cos-tag cos 0 dpl 1 pcp 1 dei 1
qos map cos-tag cos 1 dpl 0 pcp 0 dei 0
qos map cos-tag cos 1 dpl 1 pcp 0 dei 1
qos map cos-tag cos 2 dpl 0 pcp 2 dei 0
qos map cos-tag cos 2 dpl 1 pcp 2 dei 1
qos map cos-tag cos 3 dpl 0 pcp 3 dei 0
qos map cos-tag cos 3 dpl 1 pcp 3 dei 1
qos map cos-tag cos 4 dpl 0 pcp 4 dei 0
qos map cos-tag cos 4 dpl 1 pcp 4 dei 1
qos map cos-tag cos 5 dpl 0 pcp 5 dei 0
qos map cos-tag cos 5 dpl 1 pcp 5 dei 1
qos map cos-tag cos 6 dpl 0 pcp 6 dei 0
qos map cos-tag cos 6 dpl 1 pcp 6 dei 1
qos map cos-tag cos 7 dpl 0 pcp 7 dei 0
qos map cos-tag cos 7 dpl 1 pcp 7 dei 1
qos dscp-translate disabled
qos dscp-classify disabled
qos dscp-remark disabled
qos storm unicast mode: disabled, rate: 500 kbps
qos storm broadcast mode: disabled, rate: 500 kbps
```

```
qos storm unknown mode: disabled, rate: 500 kbps
```

4.21.82 show radius-server

Command:

```
show radius-server [ statistics ]
```

show Show running system information
radius-server RADIUS configuration
statistics RADIUS statistics

Default:

N/A

Usage Guide:

To display the **RADIUS Server** configuration.

Example:

To display the **RADIUS Server** configuration.

```
Switch # show radius-server
Global RADIUS Server Timeout      : 5 seconds
Global RADIUS Server Retransmit   : 3 times
Global RADIUS Server Deadtime     : 0 minutes
Global RADIUS Server Key          :
Global RADIUS Server Attribute 4  :
Global RADIUS Server Attribute 95 :
Global RADIUS Server Attribute 32 :
No hosts configured!
```

4.21.83 show rmon alarm

Command:

```
show rmon alarm [ <id_list> ]
```

show Show running system information
rmon RMON statistics
alarm Display the RMON alarm table

Default:

N/A

Usage Guide:

To display the **RMON Alarm** configuration.

Example:

To display the **RMON Alarm ID 1** configuration.

```
Switch # show rmon alarm 1

Alarm ID :      1
-----
Interval      : 30
Variable      : .1.3.6.1.2.1.2.2.1.20.1
SampleType    : deltaValue
Value         : 0
Startup       : risingOrFallingAlarm
RisingThrlld  : 2
FallingThrlld : 1
RisingEventIndex : 2
FallingEventIndex : 1
```

4.21.84 show rmon event

Command:

```
show rmon event [ <id_list> ]
```

- show** Show running system information
- rmon** RMON statistics
- event** Display the RMON event table

Default:

N/A

Usage Guide:

To display the **RMON Event** configuration.

Example:

To display the **RMON Event ID 1** configuration.

```
Switch # show rmon event 1
```

```
Event ID :    1
-----
```

```
  Description      : 2
  Type             : none
  Community        : public
  LastSent         : Never
```

4.21.85 show rmon history

Command:

```
show rmon history [ <id_list> ]
```

show Show running system information

rmon RMON statistics

history Display the RMON history table

Default:

N/A

Usage Guide:

To display the **RMON History** configuration.

Example:

To display the **RMON History ID 1** configuration.

```
Switch # show rmon history 1
```

```
History ID :    1
-----
```

```
  Data Source      : .1.3.6.1.2.1.2.2.1.1.5
  Data Bucket Request : 50
  Data Bucket Granted : 50
  Data Interval    : 1800
```

4.21.86 show rmon statistics

Command:

```
show rmon statistics [ <id_list> ]
```

show Show running system information

rmon RMON statistics

statistics Display the RMON statistics table

Default:

N/A

Usage Guide:

To display the **RMON Statistics** configuration.

Example:

To display the **RMON Statistics ID 1** configuration.

```
Switch # show rmon statistics 1

Statistics ID :    1
-----
Data Source : .1.3.6.1.2.1.2.2.1.1.5
etherStatsDropEvents      : 3
etherStatsOctets          : 10221727
etherStatsPkts            : 127086
etherStatsBroadcastPkts   : 45280
etherStatsMulticastPkts   : 70008
etherStatsCRCAlignErrors  : 0
etherStatsUndersizePkts   : 0
etherStatsOversizePkts    : 0
etherStatsFragments       : 0
etherStatsJabbers         : 0
etherStatsCollisions      : 0
etherStatsPkts64Octets    : 26017
etherStatsPkts65to127Octets : 101063
etherStatsPkts128to255Octets : 5
etherStatsPkts256to511Octets : 1
etherStatsPkts512to1023Octets : 0
etherStatsPkts1024to1518Octets: 0
```

4.21.87 show running-config

Command:

```
show running-config [ all-defaults ] [feature <feature_name> [ all-defaults ]]
[interface vlan <list> [ all-defaults ] ] [line { console | vty } <list> [ all-defaults ]]
[vlan <list> [ all-defaults ]]
```

show Show running system information

- running-config** Show running system information
- all-defaults** Include most/all default values
- feature** Show configuration for specific feature
- <feature_name>** Valid words are 'GVRP' 'access' 'access-list' 'aggregation' 'arp-inspection' 'auth' 'clock' 'dhcp' 'dhcp-snooping' 'dhcp_server' 'dns' 'dot1x' 'eps' 'erps' 'evc' 'green-ethernet' 'http' 'icli' 'ip-igmp-snooping' 'ip-igmp-snooping-port' 'ip-igmp-snooping-vlan' 'ipmc-profile' 'ipmc-profile-range' 'ipv4' 'ipv6' 'ipv6-mld-snooping' 'ipv6-mld-snooping-port' 'ipv6-mld-snooping-vlan' 'lACP' 'link-oam' 'lldp' 'logging' 'loop-protect' 'mac' 'mep' 'monitor' 'mstp' 'mvr' 'mvr-port' 'network-clock' 'ntp' 'phy' 'poe' 'port' 'port-security' 'ptp' 'pvlan' 'qos' 'rmon' 'snmp' 'source-guard' 'ssh' 'upnp' 'user' 'vlan' 'voice-vlan' 'web-privilege-group-level'
- all-defaults** Include most/all default values
- interface** Show specific interface(s)
- vlan** VLAN
- line** Show line settings
- console** Console
- vty** VTY

Default:

N/A

Usage Guide:

To display the **running-config**.

Example 1:

To display the **running-config**.

```
Switch # show running-config
Building configuration...
username admin privilege 15 password none
loop-protect
loop-protect transmit-time 2
loop-protect shutdown-time 2
!
vlan 1
!
!
!
```

Example 2:

To display the **running-config** with filtered **MVR** function

```
Switch # show running-config feature mvr
Building configuration...
```



```

!
vlan 1
!
!
!
mvr
mvr vlan 1 name 1
    
```

4.21.88 show snmp

Command:

```
show snmp
```

show Show running system information

snmp Display SNMP configurations

Default:

N/A

Usage Guide:

To display the **SNMP** information.

Example:

To display the **SNMP** information

```
Switch # show snmp
```

```
SNMP Configuration
```

```
SNMP Mode : enabled
```

```
SNMP Version : 2c
```

```
Read Community : public
```

```
Write Community : private
```

```
Trap Mode : disabled
```

```
Trap Version : 1
```

```
SNMPv3 Communities Table:
```

```
Community : public
```

```
Source IP : 0.0.0.0
```

```
Source Mask : 0.0.0.0
```

```
Community : private
```

```
Source IP : 0.0.0.0
```

```
Source Mask : 0.0.0.0
```

SNMPv3 Users Table:

User Name : default_user
Engine ID : 800007e5017f000001
Security Level : NoAuth, NoPriv
Authentication Protocol : None
Privacy Protocol : None

SNMPv3 Groups Table;

Security Model : v1
Security Name : public
Group Name : default_ro_group

Security Model : v1
Security Name : private
Group Name : default_rw_group

Security Model : v2c
Security Name : public
Group Name : default_ro_group

Security Model : v2c
Security Name : private
Group Name : default_rw_group

Security Model : v3
Security Name : default_user
Group Name : default_rw_group

SNMPv3 Accesses Table:

Group Name : default_ro_group
Security Model : any
Security Level : NoAuth, NoPriv
Read View Name : default_view
Write View Name : <no writeview specified>

Group Name : default_rw_group
Security Model : any

```
Security Level   : NoAuth, NoPriv
Read View Name  : default_view
Write View Name : default_view
```

SNMPv3 Views Table:

```
View Name       : default_view
OID Subtree    : .1
View Type      : included
```

4.21.89 show snmp access

Command:

```
show snmp access [ <group_name> { v1 | v2c | v3 | any } { auth | noauth | priv } ]
```

show Show running system information

snmp Display SNMP configurations

access access configuration

<GroupName : word32> group name

any any security model

v1 v1 security model

v2c v2c security model

v3 v3 security model

auth authNoPriv Security Level

noauth noAuthNoPriv Security Level

priv authPriv Security Level

Default:

N/A

Usage Guide:

To display the **SNMP Access** information.

Example:

To display the **SNMP Access** information

```
Switch # show snmp access
Group Name       : default_ro_group
Security Model   : any
Security Level   : NoAuth, NoPriv
Read View Name  : default_view
Write View Name  : <no writeview specified>
```

```

Group Name      : default_rw_group
Security Model  : any
Security Level  : NoAuth, NoPriv
Read View Name  : default_view
Write View Name : default_view

```

4.21.90 show snmp community v3

Command:

```
show snmp community v3 [ <community> ]
```

show Show running system information

snmp Display SNMP configurations

community Community

v3 SNMPv3

<Community : word127> Specify community name

Default:

N/A

Usage Guide:

To display the **SNMPv3 Community** information.

Example:

To display the **SNMPv3 Community** information

```

Switch # show snmp community v3

Community   : public
Source IP   : 0.0.0.0
Source Mask : 0.0.0.0

Community   : private
Source IP   : 0.0.0.0
Source Mask : 0.0.0.0

```

4.21.91 show snmp host

Command:

```
show snmp host [ <conf_name> ] [ system ] [ switch ] [ interface ] [ aaa ]
```

- show** Show running system information
- snmp** Display SNMP configurations
- host** Set SNMP host's configurations
- <ConfName : word32>** Name of the host configuration
- aaa** AAA event group
- interface** Interface event group
- switch** Switch event group
- system** System event group

Default:

N/A

Usage Guide:

To display the **SNMP Host** information.

Example:

To display the **SNMP Host** information

```
Switch # show snmp host
Trap Global Mode: Disabled
```

4.21.92 show snmp mib context

Command:

```
show snmp mib context
```

- show** Show running system information
- snmp** Display SNMP configurations
- mib** MIB(Management Information Base)
- context** MIB context

Default:

N/A

Usage Guide:

To display the **SNMP MIB contexts**.

Example:

To display the **SNMP MIB contexts**.

```
Switch # show snmp mib context
```

BRIDGE-MIB :

- dot1dBase (.1.3.6.1.2.1.17.1)
- dot1dTp (.1.3.6.1.2.1.17.4)

Dot3-OAM-MIB :

- dot3OamMIB (.1.3.6.1.2.1.158)

ENTITY-MIB :

- entityMIBObjects (.1.3.6.1.2.1.47.1)

EtherLike-MIB :

- transmission (.1.3.6.1.2.1.10)

IEEE8021-MSTP-MIB :

- ieee8021MstpMib (.1.3.111.2.802.1.1.6)

IEEE8021-PAE-MIB :

- ieee8021paeMIB (.1.0.8802.1.1.1.1)

IEEE8023-LAG-MIB :

- lagMIBObjects (.1.2.840.10006.300.43.1)

IF-MIB :

- ifMIB (.1.3.6.1.2.1.31)

IP-FORWARD-MIB :

- ipForward (.1.3.6.1.2.1.4.24)

IP-MIB :

- ipv4InterfaceTable (.1.3.6.1.2.1.4.28)
- ipv6InterfaceTable (.1.3.6.1.2.1.4.30)
- ipTrafficStats (.1.3.6.1.2.1.4.31)
- ipAddressTable (.1.3.6.1.2.1.4.34)
- ipNetToPhysicalTable (.1.3.6.1.2.1.4.35)
- ipv6ScopeZoneIndexTable (.1.3.6.1.2.1.4.36)
- ipDefaultRouterTable (.1.3.6.1.2.1.4.37)
- icmpStatsTable (.1.3.6.1.2.1.5.29)
- icmpMsgStatsTable (.1.3.6.1.2.1.5.30)

LLDP-EXT-MED-MIB :

- lldpXMedMIB (.1.0.8802.1.1.2.1.5.4795.1)

LLDP-MIB :

- lldpObjects (.1.0.8802.1.1.2.1)

MAU-MIB :

- snmpDot3MauMgt (.1.3.6.1.2.1.26)

MGMD-MIB :

- mgmdMIBObjects (.1.3.6.1.2.1.185.1)

P-BRIDGE-MIB :

- pBridgeMIB (.1.3.6.1.2.1.17.6)

POWER-ETHERNET-MIB :

- powerEthernetMIB (.1.3.6.1.2.1.105)

Q-BRIDGE-MIB :

- qBridgeMIB (.1.3.6.1.2.1.17.7)

RADIUS-ACC-CLIENT-MIB :

- radiusAccClientMIBObjects (.1.3.6.1.2.1.67.2.2.1)

RADIUS-AUTH-CLIENT-MIB :

- radiusAuthClientMIBObjects (.1.3.6.1.2.1.67.1.2.1)

RFC1213-MIB :

- system (.1.3.6.1.2.1.1)
- interfaces (.1.3.6.1.2.1.2)
- ip (.1.3.6.1.2.1.4)
- snmp (.1.3.6.1.2.1.5)
- tcp (.1.3.6.1.2.1.6)
- udp (.1.3.6.1.2.1.7)

RMON-MIB :

- statistics (.1.3.6.1.2.1.16.1)
- history (.1.3.6.1.2.1.16.2)
- alarm (.1.3.6.1.2.1.16.3)
- event (.1.3.6.1.2.1.16.9)

SMON-MIB :

- switchRMON (.1.3.6.1.2.1.16.22)

SNMP-FRAMEWORK-MIB :

- snmpEngine (.1.3.6.1.6.3.10.2.1)

SNMP-MPD-MIB :

- dot1dTpHCPortTable (.1.3.6.1.2.1.17.4.5)
- snmpMPDStats (.1.3.6.1.6.3.11.2.1)

SNMP-USER-BASED-SM-MIB :

- usmStats (.1.3.6.1.6.3.15.1.1)
- usmUserTable (.1.3.6.1.6.3.15.1.2)

SNMP-VIEW-BASED-ACM-MIB :

- vacmContextTable (.1.3.6.1.6.3.16.1.1)
- vacmSecurityToGroupTable (.1.3.6.1.6.3.16.1.2)
- vacmAccessTable (.1.3.6.1.6.3.16.1.4)
- vacmMIBViews (.1.3.6.1.6.3.16.1.5)

4.21.93 show snmp mib ifmib ifIndex

Command:

```
show snmp mib ifmib ifIndex
```

show Show running system information

snmp Display SNMP configurations
mib MIB(Management Information Base)
ifmib IF-MIB
ifIndex The IfIndex that is defined in IF-MIB

Default:

N/A

Usage Guide:

To display the **SNMP MIB ifIndex contexts**.

Example:

To display the **SNMP MIB ifIndex contexts**.

```
Switch # show snmp mib ifmib ifIndex
ifIndex   ifDescr                               Interface
-----   -
```

1	Switch 1 - Port 1	GigabitEthernet 1/1
2	Switch 1 - Port 2	GigabitEthernet 1/2
3	Switch 1 - Port 3	GigabitEthernet 1/3
4	Switch 1 - Port 4	GigabitEthernet 1/4
5	Switch 1 - Port 5	GigabitEthernet 1/5
6	Switch 1 - Port 6	GigabitEthernet 1/6
7	Switch 1 - Port 7	GigabitEthernet 1/7
8	Switch 1 - Port 8	GigabitEthernet 1/8
9	Switch 1 - Port 9	GigabitEthernet 1/9
10	Switch 1 - Port 10	GigabitEthernet 1/10
11	Switch 1 - Port 11	GigabitEthernet 1/11
12	Switch 1 - Port 12	GigabitEthernet 1/12
13	Switch 1 - Port 13	GigabitEthernet 1/13
14	Switch 1 - Port 14	GigabitEthernet 1/14
15	Switch 1 - Port 15	GigabitEthernet 1/15
16	Switch 1 - Port 16	GigabitEthernet 1/16
17	Switch 1 - Port 17	GigabitEthernet 1/17
18	Switch 1 - Port 18	GigabitEthernet 1/18
19	Switch 1 - Port 19	GigabitEthernet 1/19
20	Switch 1 - Port 20	GigabitEthernet 1/20
21	Switch 1 - Port 21	GigabitEthernet 1/21
22	Switch 1 - Port 22	GigabitEthernet 1/22
23	Switch 1 - Port 23	GigabitEthernet 1/23
24	Switch 1 - Port 24	GigabitEthernet 1/24
25	Switch 1 - Port 25	10GigabitEthernet 1/1
26	Switch 1 - Port 26	10GigabitEthernet 1/2

27	Switch	1 - Port 27	10GigabitEthernet 1/3
28	Switch	1 - Port 28	10GigabitEthernet 1/4
29	Switch	1 - Port 29	GigabitEthernet 1/25
50001	VLAN	1	vlan 1
60001	IP Interface	1	vlan 1

4.21.94 show snmp security-to-group

Command:

```
show snmp security-to-group [ { v1 | v2c | v3 } <security_name> ]
```

show Show running system information
snmp Display SNMP configurations
security-to-group security-to-group configuration
v1 v1 security model
v2c v2c security model
v3 v3 security model
<SecurityName : word32> security group name

Default:

N/A

Usage Guide:

To display the **SNMP Group** information.

Example:

To display the **SNMP Group** information.

```
Switch # show snmp security-to-group
Security Model : v1
Security Name   : public
Group Name      : default_ro_group

Security Model : v1
Security Name   : private
Group Name      : default_rw_group

Security Model : v2c
Security Name   : public
```

```

Group Name      : default_ro_group

Security Model : v2c
Security Name   : private
Group Name      : default_rw_group

Security Model : v3
Security Name   : default_user
Group Name      : default_rw_group
    
```

4.21.95 show snmp user

Command:

```

show snmp user [ <username> <engineID> ]
    
```

- show** Show running system information
- snmp** Display SNMP configurations
- user** User
- <Username : word32>** Security user name
- <Engiedid : word10-32>** Security Engine ID

Default:

N/A

Usage Guide:

To display the **SNMP User** information.

Example:

To display the **SNMP User** information.

```

Switch # show snmp user

User Name      : default_user
Engine ID      : 800007e5017f000001
Security Level  : NoAuth, NoPriv
Authentication Protocol : None
Privacy Protocol   : None
    
```

4.21.96 show snmp view

Command:

```
show snmp view [ <view_name> <oid_subtree> ]
```

show Show running system information

snmp Display SNMP configurations

view MIB view configuration

<ViewName : word32> MIB view name

<OldSubtree : word255> MIB view OID

Default:

N/A

Usage Guide:

To display the **SNMP viewer** information.

Example:

To display the **SNMP viewer** information.

```
Switch # show snmp view
View Name   : default_view
OID Subtree : .1
View Type   : included
```

4.21.97 show spanning-tree

Command:

```
show spanning-tree [ summary | active | { interface ( <port_type>
[ <port_type_list> ] ) } | { detailed [ interface ( <port_type> [ <port_type_list> ] ) } ] |
{ mst [ configuration | { <instance> [ interface ( <port_type>
[ <port_type_list> ] ) } ] } ] ] ] ]
```

show Show running system information

spanning-tree STP Bridge

active STP active interfaces

detailed STP statistics

interface Choose port

summary STP summary

mst Configuration

configuration STP bridge instance no (0-7, CIST=0, MST1=1...)

<Instance : 0-7> Choose port

Default:

N/A

Usage Guide:

To display the **STP** information.

Example:

To display the **STP** information.

```
Switch # show spanning-tree
CIST Bridge STP Status
Bridge ID   : 32768.00-30-4F-00-99-00
Root ID    : 32768. 00-30-4F-00-99-00
Root Port  : -
Root PathCost: 0
Regional Root: 32768. 00-30-4F-00-99-00
Int. PathCost: 0
Max Hops   : 20
TC Flag    : Steady
TC Count   : 0
TC Last    : -
Port       Port Role   State   Pri PathCost Edge P2P Uptime
-----
-----
```

4.21.98 show switchport forbidden

Command:

```
show switchport forbidden [ { vlan <vid> } | { name <name> } ]
```

- show** Show running system information
- switchport** Display switching mode characteristics
- forbidden** Lookup VLAN Forbidden port entry
- name** name - Show forbidden access for specific VLAN name
- vlan** vid - Show forbidden access for specific VLAN id

Default:

N/A

Usage Guide:

To display the **VLAN Forbidden** port entry.

Example:

To display the **VLAN Forbidden** port entry.

```
Switch # show switchport forbidden
VID Interfaces
```

```

-----
2      1

```

4.21.99 show tacacs-server

Command:

```

show tacacs-server

```

show Show running system information
tacacs-server TACACS+ configuration

Default:

N/A

Usage Guide:

To display the **TACACS+ Server** configuration.

Example:

To display the **TACACS+ Server** configuration.

```

Switch # show tacacs-server
Global TACACS+ Server Timeout      : 5 seconds
Global TACACS+ Server Deadtime    : 0 minutes
Global TACACS+ Server Key         :
No hosts configured!

```

4.21.100 show terminal

Command:

```

show terminal

```

show Show running system information
terminal Display terminal configuration parameters

Default:

N/A

Usage Guide:

To display the your login information.

Example:

To display the your login information.

```
Switch # show terminal
Line is con 0.
    * You are at this line now.
Alive from Console.
Default privileged level is 2.
Command line editing is enabled
Display EXEC banner is enabled.
Display Day banner is enabled.
Terminal width is 80.
    length is 24.
    history size is 32.
    exec-timeout is 10 min 0 second.

Current session privilege is 15.
Elapsed time is 0 day 1 hour 12 min 15 sec.
Idle time is 0 day 0 hour 0 min 0 sec.
```

4.21.101 show upnp

Command:

```
show upnp
```

show Show running system information

upnp Display UPnP configurations

Default:

N/A

Usage Guide:

To display the **UPnP** information.

Example:

To display the **UPnP** information.

```
Switch # show upnp
UPnP Mode           : Disabled
UPnP TTL            : 4
UPnP Advertising Duration : 100
```

4.21.102 show users

Command:

```
show users [ myself ]
```

show Show running system information
users Display information about terminal lines
myself Display information about mine

Default:

N/A

Usage Guide:

To display the user status.

Example:

To display the user status for all.

```
Switch # show users
Line is con 0.
  * You are at this line now.
  Connection is from Console.
  User name is admin.
  Privilege is 15.
  Elapsed time is 0 day 1 hour 20 min 49 sec.
  Idle time is 0 day 0 hour 0 min 0 sec.

Line is vty 0.
  Connection is from 192.168.0.45:49527 by Telnet.
  User name is admin.
  Privilege is 15.
  Elapsed time is 0 day 0 hour 8 min 46 sec.
  Idle time is 0 day 0 hour 8 min 42 sec.
```

4.21.103 show version

Command:

```
show version
```

show Show running system information
version System hardware and software status

Default:

N/A

Usage Guide:

To display the **software and system** information.

Example:

To display the **software and system** information.

```
Switch # show verison

MAC Address      : 00-30-4f-00-99-00
System Contact   :
System Name      :
System Location   :
System Time      : 1970-01-01T22:56:08+00:00
System Uptime    : 22:56:08

Active Image
-----
Image           : managed
Version        : 000
Date           : 2013-12-06T15:22:03+01:00

Alternate Image
```



```

-----
Image           : managed.bk
Version         : 000
Date            : 2013-10-02T15:15:04+02:00

Product         : Planet Best Switch
Software Version : 000
Build Date      : 2013-12-06T15:22:03+01:00

```

4.21.104 show vlan

Command:

```
show vlan [ id <vlan_list> | name <name> | brief ]
```

show Show running system information
vlan VLAN status
id VLAN status by VLAN id
name VLAN status by VLAN name
brief VLAN summary information

Default:

N/A

Usage Guide:

To display the **VLAN** information.

Example:

To display the **VLAN** information.

```

Switch # show vlan
VLAN  Name                               Interfaces
-----
1     default                               Gi 1/1-25 10G 1/1-4

```

4.21.105 show vlan ip-subnet

Command:

```
show vlan ip-subnet [ id <subnet_id> ]
```

show Show running system information
vlan VLAN status
ip-subnet Show VLAN ip-subnet entries

id Show a specific ip-subnet entry

Default:

N/A

Usage Guide:

To display the **IP-based VLAN** information.

Example:

To display the **IP-based VLAN** information.

```
Switch # show vlan ip-subnet
VCE ID  IP Address      Mask Length  VID  Interfaces
-----  -
1       192.168.78.0      24          5   GigabitEthernet 1/1
```

4.21.106 show vlan mac

Command:

```
show vlan mac [ address <mac_addr> ]
```

- show** Show running system information
- vlan** VLAN status
- mac** Show VLAN MAC entries
- address** Show a specific MAC entry

Default:

N/A

Usage Guide:

To display the **MAC-based VLAN** information.

Example:

To display the **MAC-based VLAN** information.

```
Switch # show vlan mac
MAC Address      VID  Interfaces
-----  ---  -
00-40-55-00-00-00  1   GigabitEthernet 1/1
```

4.21.107 show vlan protocol

Command:

```
show vlan protocol [ eth2 { <etype> | arp | ip | ipx | at } ] [ snap { <oui> | rfc-1042 |
snap-8021h } <pid> ] [ llc <dsap> <ssap> ]
```

- show** Show running system information
- vlan** VLAN status
- protocol** Protocol-based VLAN status
- eth2** Ethernet protocol based VLAN status
- <etype>** Ether Type(Range: 0x600 - 0xFFFF)
- arp** Ether Type is ARP
- at** Ether Type is AppleTalk
- ip** Ether Type is IP
- ipx** Ether Type is IPX
- llc** LLC-based VLAN status
- <dsap>** DSAP (Range: 0x00 - 0xFF)
- <ssap>** SSAP (Range: 0x00 - 0xFF)
- snap** SNAP-based VLAN status
- <oui>** SNAP OUI (Range 0x000000 - 0FFFFFFF)
- rfc-1042** SNAP OUI is rfc-1042
- snap-8021h** SNAP OUI is 8021h
- <pid>** PID (Range: 0x0 - 0xFFFF)

Default:

N/A

Usage Guide:

To display the **Protocol-based VLAN** information.

Example:

To display the **Protocol-based VLAN** information.

```
Switch # show vlan protocol
Protocol Type  Protocol (Value)          Group ID
-----
LLC_SNAP      OUI-00:e0:2b; PID:0x1    q

Switch 1
-----
Group ID      VID  Ports
-----
q             2   GigabitEthernet 1/1
```

4.21.108 show voice vlan

Command:

```
show voice vlan [ oui <oui> | interface ( <port_type> [ <port_list> ] ) ]
```

show Show running system information
voice Voice appliance attributes
vlan Vlan for voice traffic
interface Select an interface to configure
oui OUI configuration
<oui> OUI value

Default:

N/A

Usage Guide:

To display the **Voice VLAN** information.

Example:

To display the **Voice VLAN** information for **GigabitEthernet 1/1**

```
Switch # show voice vlan interface GigabitEthernet 1/1

GigabitEthernet 1/1 :
-----
GigabitEthernet 1/1 switchport voice vlan mode is auto
GigabitEthernet 1/1 switchport voice security is disabled
GigabitEthernet 1/1 switchport voice discovery protocol is oui
```

4.21.109 show web privilege group

Command:

```
show web privilege group [ <group_name> ] level
```

show Show running system information
web Web
privilege Web privilege
group Web privilege group
<group_name> Valid words are 'Aggregation' 'DHCP' 'Debug' 'Dhcp_Client' 'Diagnostics' 'EPS' 'ERPS' 'ETH_LINK_OAM' 'EVC' 'Green_Ethernet' 'IP2' 'IPMC_Snooping' 'LACP' 'LLDP' 'Loop_Protect' 'MAC_Table' 'MEP' 'MVR' 'Maintenance' 'Mirroring' 'NTP' 'POE' 'PTP' 'Ports' 'Private_VLANs' 'QoS' 'RPC' 'Security' 'Spanning_Tree' 'System' 'Timer' 'UPnP' 'VCL' 'VLAN_Translation' 'VLANs' 'Voice_VLAN' 'XXRP' 'ZL_3034X_API'

level Web privilege group level

Default:

N/A

Usage Guide:

To display the **Web privilege group**.

Example:

To display the **Web privilege group**

Switch # show web privilege group level				
Group Name	Privilege Level			
	CRO	CRW	SRO	SRW
Aggregation	6	10	5	10
Debug	15	15	15	15
DHCP	5	10	5	10
Dhcp_Client	5	10	5	10
Diagnostics	5	10	5	10
EPS	5	10	5	10
ERPS	5	10	5	10
ETH_LINK_OAM	5	10	5	10
EVC	5	10	5	10
Green_Ethernet	5	10	5	10
IP2	5	10	5	10
IPMC_Snooping	5	10	5	10
LACP	5	10	5	10
LLDP	5	10	5	10
Loop_Protect	5	10	5	10
MAC_Table	5	10	5	10
Maintenance	15	15	15	15
MEP	5	10	5	10
Mirroring	5	10	5	10
MVR	5	10	5	10
NTP	5	10	5	10
POE	5	10	5	10
Ports	5	10	1	10
Private_VLANs	5	10	5	10
PTP	5	10	5	10
QoS	5	10	5	10
RPC	5	10	5	10
Security	5	10	5	10
Spanning_Tree	5	10	5	10

System	5	10	1	10
Timer	5	10	5	10
UPnP	5	10	5	10
VCL	5	10	5	10
VLAN_Translation	5	10	5	10
VLANs	5	10	5	10
Voice_VLAN	5	10	5	10
XXRP	5	10	5	10
ZL_3034X_API	5	10	5	10

4.22 terminal

4.22.1 terminal editing

Command:

terminal editing

terminal Set terminal line parameters

editing Enable command line editing

Default:

Enabled

Usage Guide:

To enable editing mode for current terminal session.

Example:

To enable editing mode for current terminal session.

Switch # **terminal editing**

4.22.2 terminal exec-timeout

Command:

terminal exec-timeout <min> [<sec>]

terminal Set terminal line parameters

exec-timeout Set the EXEC timeout

<min> Timeout in minutes

<sec> Timeout in seconds

Default:

N/A

Usage Guide:

To configure idle timeout of EXEC mode for current terminal session.

Example:

To configure idle timeout with 500 minutes of EXEC mode for current terminal session.

```
Switch # terminal exec-timeout 500
```

4.22.3 terminal history size

Command:

```
terminal history size <history_size>
```

terminal Set terminal line parameters

history Control the command history function

size Set history buffer size

<history_size> Number of history commands, 0 means disable

Default:

N/A

Usage Guide:

To configure history buffer size for current terminal session.

Example:

To configure history buffer size with 20 lines for current terminal session.

```
Switch # terminal history size 20
```

4.22.4 terminal length

Command:

```
terminal length <lines>
```

terminal Set terminal line parameters

length Set number of lines on a screen

<lines: 0 or 3-512> Number of lines on screen (0 for no pausing)

Default:

N/A

Usage Guide:

To configure length of command display for current terminal session.

Example:

To configure length of command display with 5 lines for current terminal session.

```
Switch # terminal length 5
Switch # show run
Building configuration...
username admin privilege 15 password none
loop-protect
-- more --, next page: Space, continue: g, quit: ^C
```

4.22.5 terminal width

Command:

```
terminal width <lines>
```

- terminal** Set terminal line parameters
- width** Set width of the display terminal
- <lines:0 or 40-512>** Number of characters on a screen line (0 for unlimited width)

Default:

N/A

Usage Guide:

To configure width of command display for current terminal session.

Example:

To configure width of command display with 40 characters per line for current terminal session.

```
Switch # terminal width 40
```